



TI-Innovator™ Technology Guidebook

Learn more about TI Technology through the online help at education.ti.com/eguide.

Important Information

Except as otherwise expressly stated in the License that accompanies a program, Texas Instruments makes no warranty, either express or implied, including but not limited to any implied warranties of merchantability and fitness for a particular purpose, regarding any programs or book materials and makes such materials available solely on an "as-is" basis. In no event shall Texas Instruments be liable to anyone for special, collateral, incidental, or consequential damages in connection with or arising out of the purchase or use of these materials, and the sole and exclusive liability of Texas Instruments, regardless of the form of action, shall not exceed the amount set forth in the license for the program. Moreover, Texas Instruments shall not be liable for any claim of any kind whatsoever against the use of these materials by any other party.

Learning More with the TI-Innovator™ Technology eGuide

Parts of this document refer you to the TI-Innovator™ Technology eGuide for more details. The eGuide is a Web-based source of TI-Innovator™ information, including:

- Programming with the TI CE Family of Graphing Calculators and TI-Nspire™ Technology, including sample programs.
- Available I/O Modules and their commands.
- Available breadboard components and their commands.
- Available TI-RGB Array and its commands.
- Available TI-Innovator™ Rover and its commands.
- Link to update the TI-Innovator™ Sketch software.
- Free classroom activities for TI-Innovator™ Hub.

<https://education.ti.com/go/eguide/hub/EN>



Apple®, Chrome®, Excel®, Google®, Firefox®, Internet Explorer®, Mac®, Microsoft®, Mozilla®, Safari®, and Windows® are registered trademarks of their respective owners.

QR Code® is a registered trademark of DENSO WAVE INCORPORATED.

Select images were created with Fritzing.

© 2011 - 2021 Texas Instruments Incorporated.

Actual products may vary slightly from provided images.

Contents

TI-Innovator™ Hub Getting Started Guide	1
TI-Innovator™ Hub Overview	2
Learn More	2
What's in the Box	3
TI-Innovator™ Hub with On-Board Components	3
Built-in Ports	3
USB Cables	4
Auxiliary Power	4
Connecting TI-Innovator™ Hub	4
Connecting to a Graphing Calculator	5
Connecting to a Computer Running TI-Nspire™ CX Software	6
Updating the Hub Software	6
What is the TI-Innovator™ sketch?	6
Do I need to update the sketch on the TI-Innovator™ Hub?	6
What is the latest version of the sketch?	7
Why would I update the sketch?	7
How do I load the sketch on the TI-Innovator™ Hub?	7
Can I update multiple TI-Innovator Hubs at the same time?	7
Can the sketch that comes on the TI-Innovator™ Hub be edited to add functionality but still work with the TI calculator? Is the sketch open source?	7
Hub Programming on TI CE Graphing Calculator	8
Code Examples: TI CE Graphing Calculator	8
Sample Program to Blink an On-Board LED	8
How to Create and Execute a Program	9
Using the Hub Menu to Build Commands	10
Tips for Coding with TI CE Graphing Calculator	11
Learn More	12
TI-Innovator™ Hub App for the TI CE Graphing Calculator(s)	13
Hub Programming on TI-Nspire™ CX Technology	16
Code Examples: TI-Nspire™ CX Technology	16
Sample Program to Blink an On-Board LED	16
How to Create and Execute a Program	17
Using the Hub Menu to Build Commands	18
Tips for Coding with TI-Nspire™ CX Technology	20
Learn More	20
TI-Innovator™ I/O Modules	21
Connecting an I/O Module	23
Sample Program to Blink an LED Module	23
Learn More	23
TI-Innovator™ Breadboard Pack	25

Addressable Components	25
Sample Code to Blink a Breadboard LED	26
Breadboard Basics	27
Learn More	28
Using an Auxiliary Power Source	28
Connecting the Power Source	29
TI-Innovator™ Hub Troubleshooting	30
General Precautions for the TI-Innovator™ Hub	31
TI-Innovator™ Hub	31
Breadboard Connector on the Hub	31
Breadboard	31
I/O Modules	31
TI-Innovator™ Rover	32

TI-Innovator™ Hub Commands Version 1.5 **34**

Understanding Syntax	34
Last Menu Entry	34
HUB Menus	35
Send("SET...	36
Send("READ...	36
Settings...	37
Wait	37
Get(.....	38
eval(.....	38
Rover (RV)...	38
Send("CONNECT-Output...	38
Send("CONNECT-Input...	39
Ports...	40
Send("RANGE...	40
Send("AVERAGE...	40
Send("DISCONNECT-Output...	41
Send("DISCONNECT-Input...	41
MANAGE	42
COLLECT	42
Additional Supported Commands Not Found in the Hub Menu	43
SET	45
LIGHT [TO] ON/OFF	46
COLOR [TO] r g b [[BLINK TOGGLE] frequency] [[TIME] seconds]	46
SOUND [TO] frequency [[TIME] seconds]	47
TEMPO keyword for SOUND/SPEAKER	47
SOUND OFF/0	48
LED i [TO] ON/OFF	48
LED i [TO] 0-255	49

RGB i [TO] r g b [[BLINK TOGGLE] frequency] [[TIME] seconds]	49
COLOR.RED i [TO] ON/OFF/UP/DOWN/value [[BLINK TOGGLE] frequency] [[TIME] seconds]	50
COLOR.GREEN i [TO] ON/OFF/UP/DOWN/value [[BLINK TOGGLE] frequency] [[TIME] seconds]	50
COLOR.BLUE i [TO] ON/OFF/UP/DOWN/value [[BLINK TOGGLE] frequency] [[TIME] seconds]	51
SPEAKER i [TO] frequency [[TIME] seconds]	51
TEMPO keyword for SOUND/SPEAKER	52
POWER	52
SERVO i [TO] position	53
SERVO i [TO] STOP	53
SERVO i [TO] ZERO	54
SERVO i [TO] [CW/CCW] speed [[TIME] seconds]	54
ANALOG.OUT i [TO]	55
ANALOG.OUT i OFF STOP	55
VIB.MOTOR i [TO] PWM	56
VIB.MOTOR i [TO] OFF STOP	56
VIB.MOTOR i [TO] 0-255/UP/DOWN/ON/OFF [[BLINK TOGGLE] freq] [[TIME] seconds]	57
COLOR.RED [TO] r [[BLINK TOGGLE] frequency] [[TIME] seconds]	57
COLOR.GREEN [TO] g [[BLINK TOGGLE] frequency] [[TIME] seconds]	58
COLOR.BLUE [TO] b [[BLINK TOGGLE] frequency] [[TIME] seconds]	58
BUZZER i [TO] ON [TIME seconds]	59
BUZZER i [TO] OFF	59
RELAY i [TO] ON/OFF	60
SQUAREWAVE i [TO] frequency [duty [[TIME] seconds]]	60
SQUAREWAVE i OFF	61
DIGITAL.OUT i [TO] ON/OFF/HIGH/LOW/[[BLINK TOGGLE] frequency] [[TIME] seconds]	61
DIGITAL.OUT i [TO] OUTPUT/CLOCK	62
DIGITAL.IN i [TO] INPUT/PULLUP/PULLDOWN	62
AVERAGING [TO] n	62
BBPORT	64
READ	65
BRIGHTNESS	65
BRIGHTNESS AVERAGE	66
BRIGHTNESS RANGE	66
DHT i	67
DHT i TEMPERATURE	68
DHT i HUMIDITY	69
RANGER i	69
READ RANGER i TIME	70
LIGHTLEVEL i	70

LIGHTLEVEL i AVERAGE	71
LIGHTLEVEL i RANGE	72
TEMPERATURE i	72
TEMPERATURE i AVERAGE	73
TEMPERATURE i CALIBRATION	73
MOISTURE i	74
MOISTURE i AVERAGE	74
MOISTURE i RANGE	75
MAGNETIC	75
VERNIER	76
ANALOG.IN i	76
ANALOG.IN i AVERAGE	76
ANALOG.IN i RANGE	77
ANALOG.OUT i	77
DIGITAL.IN i	78
SWITCH i	78
BUTTON i	79
MOTION i	79
POTENTIOMETER i	80
POTENTIOMETER i AVERAGE	80
POTENTIOMETER i RANGE	81
THERMISTOR i	81
THERMISTOR i AVERAGE	82
THERMISTOR i CALIBRATION	82
AVERAGING	83
LOUDNESS i	83
LOUDNESS i AVERAGE	84
LOUDNESS i RANGE	84
BBPORT	86
TIMER	87
Settings	88
Wait	88
Wait	89
Get(.....	89
Get(.....	90
eval(.....	91
eval(.....	91
CONNECT-Output	93
LED i [TO] OUT n/BB n	93
RGB i / COLOR [TO] BB r BB g BB b	94
SPEAKER i [TO] OUT n/BB n	94
POWER	95
SERVO.CONTINUOUS i [TO] BB 6	95

ANALOG.OUT i [TO] OUT i/BB i	96
VIB.MOTOR	96
BUZZER i [TO] OUT n/BB n	97
RELAY i [TO] OUT n/BB n	97
SERVO i [TO] OUT 3	98
SQUAREWAVE i [TO] OUT n/BB n	98
DIGITAL.OUT i [TO] OUT n/BB n [[AS] OUTPUT]	99
BBPORT	100
DCMOTOR i [TO] OUT n/BB n	100
LIGHT	101
COLOR	101
SOUND	102
CONNECT-Input	103
DHT i [TO] IN n	103
RANGER i [TO] IN n	104
LIGHTLEVEL i [TO] IN n/BB n	104
TEMPERATURE i [TO] IN n/BB n	105
MOISTURE i [TO] IN n/BB n	106
MAGNETIC	107
VERNIER	107
ANALOG.IN i [TO] IN n/BB n	108
DIGITAL.IN i [TO] IN n/BB n [[AS] INPUT PULLUP PULLDOWN]	108
SWITCH i [TO] IN n/BB n	109
BUTTON i [TO] IN n/BB n	109
MOTION i [TO] IN n/BB n	110
POTENTIOMETER i [TO] IN n/BB n	110
THERMISTOR i [TO] IN n/BB n	111
RGB	111
LOUDNESS i [TO] IN n	112
BBPORT	113
BRIGHTNESS	113
Ports	114
RANGE	115
BRIGHTNESS minimum maximum	115
LOUDNESS i minimum maximum	116
LIGHTLEVEL i minimum maximum	116
TEMPERATURE i minimum maximum	117
POTENTIOMETER i minimum maximum	117
MOISTURE i minimum maximum	118
THERMISTOR i minimum maximum	118
ANALOG.IN i minimum maximum	119
AVERAGE	120
BRIGHTNESS n	121

LOUDNESS i n	121
LIGHTLEVEL i n	121
TEMPERATURE i n	122
POTENTIOMETER i n	122
MOISTURE i n	123
THERMISTOR i n	123
ANALOG.IN i n	124
PERIOD n	124
DISCONNECT-Output	125
LED i	126
RGB i	126
SPEAKER i	126
POWER	127
SERVO.CONTINUOUS i	127
ANALOG.OUT i	128
VIB.MOTOR	129
BUZZER i	129
RELAY i	129
SERVO i	130
SQUAREWAVE i	130
DIGITAL.OUT i	131
BBPORT	132
LIGHT	132
COLOR	132
SOUND	133
DCMOTOR i	133
DISCONNECT-Input	135
DHT i	135
RANGER i	136
LIGHTLEVEL i	136
TEMPERATURE i	137
MOISTURE i	137
MAGNETIC	138
VERNIER	138
ANALOG.IN i	139
DIGITAL.IN i	139
SWITCH	139
BUTTON i	140
MOTION i	140
POTENTIOMETER i	141
THERMISTOR i	141
RGB	142
LOUDNESS i	142

BBPORT	143
BRIGHTNESS	143
MANAGE	144
BEGIN	144
BEGIN	144
ISTI	145
ISTI	145
WHO	145
WHO	145
WHAT	146
WHAT	146
HELP	146
HELP	146
VERSION	147
VERSION	147
ABOUT	147
ABOUT	147
COLLECT	148
COLLECT	148
READ COLLECT	151
Additional Supported Commands	153
Additional SET Commands	153
FORMAT ERROR STRING/NUMBER	153
FORMAT ERROR NOTE/QUIET	153
FLOW [TO] ON/OFF	154
OUT1/2/3 [TO]	155
Additional READ Commands	156
BUZZER i	156
COLOR	156
COLOR.RED	157
COLOR.GREEN	157
COLOR.BLUE	158
DCMOTOR i	159
DIGITAL.OUT i	159
FORMAT	160
FLOW	160
IN1/IN2/IN3	161
LAST ERROR	161
LED i	162
LIGHT	162
OUT1/2/3	163
PWR	163
RELAY i	164

RESOLUTION	164
RGB i	164
RED i	165
GREEN i	166
BLUE i	166
SERVO i	167
SERVO i CALIBRATION	167
SOUND	168
SPEAKER i	168
SQUAREWAVE i	169
Additional AVERAGE Commands	170
PERIOD n	170
Additional CALIBRATION Commands	171
CALIBRATE	171
SERVO i / SERVO.CONTINUOUS i	171
TEMPERATURE i C1 C2 C3 R1	172
THERMISTOR i C1 C2 C3 R1	173
TI-Innovator™ Hub Data Sheets	174
TI-Innovator™ Hub Data Sheet	175
TI-Innovator™ Hub Ports and Breadboard Usable Pins	176
Breadboard Connector Characteristics	176
TI-Innovator™ Hub On-Board Component Data Sheets	177
On-Board RGB LED Data Sheet	177
On-Board Red LED Data Sheet	179
On-Board Speaker Data Sheet	180
On-Board Light Brightness Sensor Data Sheet	182
On-Board - Auxiliary Power Indicator Data Sheet	183
On-Board Green LED - Power Indicator Data Sheet	184
On-Board Red LED - Error Indicator Data Sheet	185
USB Mini A to Mini B Cable Data Sheet	186
USB Standard A to Mini B Cable Data Sheet	187
USB Standard A to Micro B Cable Data Sheet	188
TI Wall Charger Data Sheet	189
External Battery Data Sheet	190
TI-Innovator™ Rover Setup Guide	191
TI-Innovator™ Rover Overview	192
Learn More	192
TI-Innovator™ Rover Setup Requirements	193
Preparing TI-Innovator™ Rover	194
Connecting TI-Innovator™ Rover	195

Connecting TI-Innovator™ Rover to TI-Innovator™ Hub	195
Connecting TI-Innovator™ Hub to a Graphing Calculator	198
Exploring the Assembled TI-Innovator™ Rover	199
Top Side of the Rover	199
Bottom Side of the Rover	200
Front Side of the Rover	201
Back Side of the Rover	201
Right Side of the Rover	202
Left Side of the Rover	203
General Precautions for the TI-Innovator™ Rover	204
TI-Innovator™ Rover	204

TI-Innovator™ Rover Commands Version 1.5 **206**

Prerequisite: Use the Send "Connect RV" Command First	206
Named RV Subsystems	206
Rover Command Categories	207
RV Commands, Code Samples, and Syntax	208
TI-Innovator™ Rover Menu	208
Rover (RV)...	208
Drive RV...	213
RV FORWARD	214
RV BACKWARD	215
RV LEFT	216
RV RIGHT	216
RV STOP	217
RV RESUME	218
RV STAY	218
RV TO XY	219
RV TO POLAR	219
RV TO ANGLE	220
READ RV Sensors...	221
RV.RANGER	221
READ RV.RANGER TIME	222
RV.COLORINPUT	222
RV.COLORINPUT.RED	223
RV.COLORINPUT.GREEN	224
RV.COLORINPUT.BLUE	224
RV.COLORINPUT.GRAY	225
RV Settings...	226
Read RV Path...	227
Reading WAYPOINT and PATH	227
RV Position and Path	228
RV.WAYPOINT.XYTHDRN	229

RV.WAYPOINT.PREV	229
RV.WAYPOINT.CMDNUM	230
RV.PATHLIST.X	231
RV.PATHLIST.Y	232
RV.PATHLIST.TIME	232
RV.PATHLIST.HEADING	233
RV.PATHLIST.DISTANCE	233
RV.PATHLIST.REVS	234
RV.PATHLIST.CMDNUM	234
RV.WAYPOINT.X	235
RV.WAYPOINT.Y	236
RV.WAYPOINT.TIME	236
RV.WAYPOINT.HEADING	237
RV.WAYPOINT.DISTANCE	237
RV.WAYPOINT.REVS	238
RV Color...	239
RV.COLOR	239
RV.COLOR.RED	239
RV.COLOR.GREEN	240
RV.COLOR.BLUE	240
RV Setup...	242
RV.POSITION	242
RV.GYRO	242
RV.GRID.ORIGIN	243
RV.GRID.M/UNIT	243
RV.PATH CLEAR	244
RV MARK	244
RV Control...	246
SET RV.MOTORS	246
SET RV.MOTOR.L	247
SET RV.MOTOR.R	247
SET RV.ENCODERSGYRO 0	248
READ RV.ENCODERSGYRO	248
READ RV.GYRO	249
READ RV.DONE	250
READ RV.ETA	251
Send "CONNECT RV"	253
CONNECT RV	253
Send "DISCONNECT RV"	254
DISCONNECT RV	254
TI-Innovator™ Rover – Programmable Component Data Sheets	255
TI-Innovator™ Rover	256

TI-Innovator™ Rover On-Board Rotary Encoders Data Sheet	257
TI-Innovator™ Rover On-Board Gyroscope Data Sheet	258
TI-Innovator™ Rover On-Board Ultrasonic Ranger Data Sheet	259
TI-Innovator™ Rover On-Board Color Sensor Data Sheet	261
On-Board Light Brightness Sensor Data Sheet	263
TI-Innovator™ Rover On-Board Electric Motors Data Sheet	264
TI-Innovator™ Rover On-Board RGB (Red-Green-Blue) LED Data Sheet	266
On-Board Speaker Data Sheet	268
I/O Modules Data Sheets	270
Environmental Sensors	271
Analog Light Sensor Data Sheet	272
Moisture Sensor Data Sheet	273
Temperature Sensor Data Sheet	275
Temperature & Humidity Sensor Data Sheet	277
Water Pump Data Sheet	279
LED and Display Sensors	280
White LED Data Sheet	281
Motion and Distance Sensors	283
Magnetic field (Hall Effect) Sensor Data Sheet	284
Ultrasonic Ranger Data Sheet	286
Motors	287
Servo Motor Data Sheet	288
Vibration Motor Data Sheet	291
Power and Signal Sensors	293
MOSFET Data Sheet	294
TI-Innovator™ Breadboard Data Sheets	296
Breadboard Components and Usable Pins	296
Environmental Sensors	298
Thermistor Data Sheet	299
TI Analog Temperature Sensor Data Sheet	300
Visible Light Sensor Data Sheet	301
LEDs and Displays	302
Green LED Data Sheet	303
RGB (Red-Green-Blue) LED Data Sheet	305
Red LED Data Sheet	307
Diode Data Sheet	309
7-segment Display Data Sheet	310
Infrared Receiver Data Sheet	311
Infrared Transmitter Data Sheet	312
Motors	313

Small DC Motor Data Sheet	313
Power and Signal Control	314
SPDT Slide Switch Data Sheet	315
8 Position DIP Switch Data Sheet	316
8 100 Ohm Resistor SIP Package Data Sheet	317
TTL Power MOSFET Data Sheet	318
Passive Components	320
Accessories	321
Breadboard Data Sheet	323
Capacitors	324
Resistors	326
TI-SensorLink Adapter	331
What is TI-SensorLink Adapter?	331
TI-SensorLink – Industrial design and markings	331
Supported Vernier Analog Sensors	332
Requirements for Vernier adapter:	333
Connecting the TI-SensorLink Adapter	334
Connect the TI-SensorLink Adapter to the TI-Innovator™ Hub	334
Connect the TI-Innovator™ Hub to a Graphing Calculator	334
Connect TI-SensorLink Adapter to a Vernier Sensor	334
Precautions for the TI-SensorLink Adapter and Vernier Sensors	335
TI-SensorLink Adapter and Vernier Sensor Data Sheets	337
TI-SensorLink Adapter Data Sheet	338
Stainless Steel Temperature Probe Data Sheet	339
pH Sensor Data Sheet	341
Gas Pressure Sensor Data Sheet	343
Dual-Range Force Sensor Data Sheet	345
Low-g Accelerometer Data Sheet	347
Light Sensor Data Sheet	348
Vernier Energy Sensor Data Sheet	350
TI-RGB Array	351
What is TI-RGB Array?	351
TI-RGB Array – Industrial design and markings	351
Requirements for TI-RGB Array:	351
Connecting the TI-RGB Array	352
Connect the TI-RGB Array to the TI-Innovator™ Hub	352
Connect the TI-Innovator™ Hub to a Graphing Calculator	352

TI-RGB Array Commands	353
Prerequisite: Use the Send "Connect RGB" Command First	353
CONNECT RGB	353
SET RGB	354
SET RGB [n1 n2 n3...] r g b	354
SET RGB PATTERN nnnn r g b	355
SET RGB ALL	355
READ RGB	356
General Precautions	356
TI-RGB Array	356
TI-RGB Array Data Sheet	357
TI-RGB Array Data Sheet	358
Breadboard Cable for TI-RGB Array Data Sheet	360
Troubleshooting	361
TI-Innovator™ Hub Troubleshooting	361
On-Board Hub Components Troubleshooting	362
TI-Innovator™ Rover Troubleshooting	363
I/O Module Troubleshooting	369
TI-SensorLink Troubleshooting	370
Programming with TI-Basic Troubleshooting	370
TI-Innovator™ Sketch Troubleshooting	371
External Battery Troubleshooting	372
TI-Innovator™ Technology General Precautions	373
TI-Innovator™ Hub	373
TI-Innovator™ Rover	373
I/O Modules Precautions	374
Breadboard Precautions	375
TI-SensorLink Adapter and Vernier Sensor Precautions	375
Frequently Asked Questions	377
Product Compatibility Information	378
TI LaunchPad™ Information	380
General Activity Information	381
General Power Information for TI-Innovator™ Hub	383
External Battery Information for TI-Innovator™ Hub	383
Rover Battery Information	384

General Information	386
Online Help	386
Contact TI Support	386
Service and Warranty	386

TI-Innovator™ Hub Getting Started Guide

The TI-Innovator™ Hub is the centerpiece of the TI-Innovator™ Technology, a project kit that extends the functionality of Texas Instruments (TI) graphing calculators to make coding and engineering design accessible to students in the classroom.

Topics to help you get started include:

- Hub Overview
- What's in the Box
- Connecting TI-Innovator™ Hub
- Updating the Hub Software
- Hub Programming on TI CE Graphing Calculator
- Hub Programming on TI-Nspire™ CX Technology
- TI-Innovator™ I/O Modules
- TI-Innovator™ Breadboard Pack
- Using an Auxiliary Power Source
- Troubleshooting
- General Precautions

TI-Innovator™ Hub Overview

The TI-Innovator™ Hub lets you use your compatible TI graphing calculator or TI-Nspire™ CX computer software to control components, read sensors, and create powerful learning experiences.

- You communicate with the Hub through TI Basic programming commands.
- Hosts that are compatible with TI-Innovator™ Hub include:
 - TI CE Family of Graphing Calculators (TI-83 Premium CE, TI-84 Plus CE, and TI-84 Plus CE-T) with operating system version 5.3 or later installed. You also need to install or update the Hub App, which contains the Hub menu.
 - TI Nspire™ CX or TI Nspire™ CX CAS handheld with operating system version 4.5 or later installed
 - TI Nspire™ computer software version 4.5 or later
- **TI-Innovator™ Hub.** Communicates with the host, the Hub on-board components, and connected external components. It also distributes power to external components.
- **TI-Innovator™ Components.** These components, sold separately, include sensors, motors, and LEDs that connect to the Hub through its I/O ports and breadboard connector.

Learn More

For a list of precautions to take while using the Hub and its components, refer to *General Precautions* (page 31).

To find information on accessories, external modules, and breadboard components, visit education.ti.com/go/innovator.

What's in the Box

TI-Innovator™ Hub with On-Board Components

- 1 A Light Brightness Sensor at the bottom of the Hub can be read as "BRIGHTNESS" in Hub command strings.
- 2 Red LED is addressable as "LIGHT" in Hub command strings.
- 3 Speaker (at back of Hub, not shown) is addressable as "SOUND" in Hub command strings.
- 4 Red-Green-Blue LED is addressable as "COLOR" in Hub command strings.

Also visible on the face of the Hub are:

- A** Green auxiliary power LED
- B** Green power LED,
- C** Red error LED.

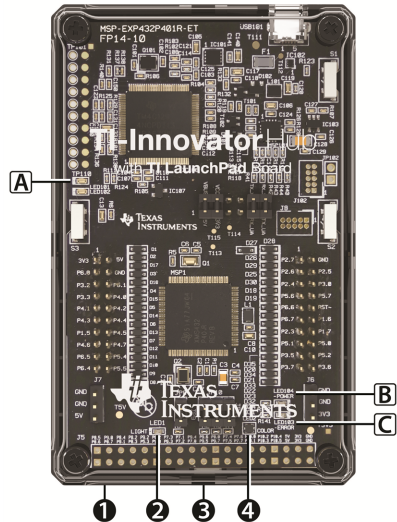

Built-in Ports

Left side - Three ports for collecting data or status from input modules:

- **IN 1** and **IN 2** provide 3.3V power.
- **IN 3** provides 5V power.

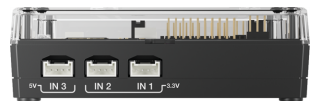

Right side - Three ports for controlling output modules:

- **OUT 1** and **OUT 2** provide 3.3V power.
- **OUT 3** provides 5V power.

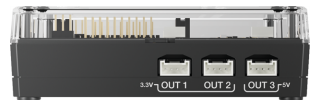

Bottom - Light Brightness Sensor (described earlier) and two ports:

- **I²C** port connects to peripherals that use the I²C communication protocol.
- **DATA** Mini-B port, used with the appropriate cable, connects to a compatible graphing calculator or computer for data and power.



Top - Two connectors:

- USB-Micro connector (**PWR**) for auxiliary power required by some components. Also used for updating the Hub internal software.
- Breadboard Connector with 20 labeled pins for communication with connected components. A breadboard and jumper cables are included with the TI-Innovator™ Breadboard Pack, sold separately.

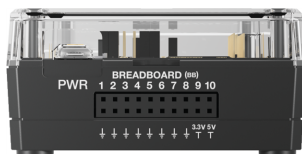

USB Cables

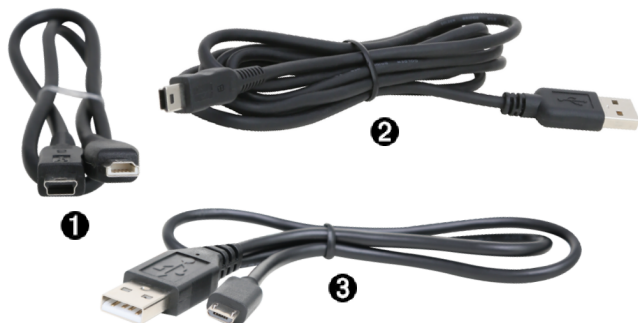

- ① USB Unit-to-Unit (Mini-A to Mini-B) - Connects the Hub to a TI CE Graphing Calculator or a TI-Nspire™ CX Handheld.
- ② USB Standard A to Mini-B - Connects the Hub to a computer running TI-Nspire™ CX Software.
- ③ USB Standard A to Micro - Connects the **PWR** port of the Hub to a TI approved power source required by some peripherals.

Auxiliary Power

TI Wall Charger - Supplies power through the TI-Innovator™ Hub for components, such as motors, that require additional power.

The optional External Battery Pack can also provide auxiliary power.

Note: An auxiliary power LED on the Hub indicates when the Hub is receiving auxiliary power.



Connecting TI-Innovator™ Hub

The TI-Innovator™ Hub connects by a USB cable to a graphing calculator or computer. The connection lets the Hub receive power and exchange data with the host.

Note: Some peripherals, such as motors, may require auxiliary power. For more information, see Using an Auxiliary Power Source (page 28).

Connecting to a Graphing Calculator

1. Identify the "B" connector on the USB Unit-to-Unit (Mini-A to Mini-B) cable. Each end of this cable is embossed with a letter.
2. Insert the "B" connector into the **DATA** port at the bottom of the TI-Innovator™ Hub.

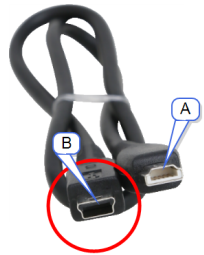

3. Insert the free end of the cable (the "A" connector) into the USB port on the calculator.



*Hub connected to
TI CE Graphing Calculator*

*Hub connected to
TI-Nspire™ CX Handheld*

4. Turn on the calculator if it is not already on.

The power LED on the Hub glows green to show that it is receiving power.

Connecting to a Computer Running TI-Nspire™ CX Software

1. Identify the "B" connector on the USB Standard A to Mini-B cable for Windows®/Mac®. Each end of this cable is embossed with a letter.
2. Insert the "B" connector into the **DATA** port at the bottom of the TI-Innovator™ Hub.
3. Insert the free end of the cable (the "A" connector) into a USB port on the computer.



The power LED on the Hub glows green to show that it is receiving power.



Updating the Hub Software

The TI-Innovator™ Hub contains software, TI-Innovator™ Sketch, that interprets Hub commands and communicates with on-board devices and connected modules. A Web-based tool lets you update the Sketch. Updated versions contain bug fixes and ensure that your TI-Innovator™ Hub can communicate with the latest components.

To obtain the latest version of the TI-Innovator™ Sketch go to the following site:

<https://education.ti.com/go/innovator>

Questions About the Hub Software

What is the TI-Innovator™ sketch?

The 'sketch' is the software on the TI-Innovator™ Hub that communicates with the graphing calculator, processes the commands, and controls the external components.

Do I need to update the sketch on the TI-Innovator™ Hub?

For best results always use the latest version of TI-Innovator™ sketch. To stay informed on any updates to the TI-Innovator™ Hub, make sure you register your product at education.ti.com/register or check the TI-Innovator™ website at education.ti.com/go/innovator.

What is the latest version of the sketch?

For best results always use the latest version of TI-Innovator sketch. You can always find the latest version of the sketch at education.ti.com/go/innovator.

Why would I update the sketch?

There are a couple of different reasons to upgrade the sketch.

1. To get the latest version from TI that may include new functionality.
2. To restore the TI sketch after loading a custom sketch – This is only needed by advanced users who use an alternative sketch.

How do I load the sketch on the TI-Innovator™ Hub?

The sketch can be updated through the TI-Innovator Hub Update Software. This software is a free download on the TI website.

Can I update multiple TI-Innovator Hubs at the same time?

The TI-Innovator Hub Update Software only allows updating a single Hub at a time. However, the application is designed to allow you to update multiple Hubs without having to re-launch the software.

Can the sketch that comes on the TI-Innovator™ Hub be edited to add functionality but still work with the TI calculator? Is the sketch open source?

The code for sketch that is loaded on the TI-Innovator™ has not been published for others to modify or edit. To maintain compatibility between the TI-Innovator™ Hub and TI calculator products, only use the officially published sketch for TI-Innovator™ Hub.

Hub Programming on TI CE Graphing Calculator

Note: These instructions apply to TI CE graphing calculator. For similar instructions for TI-Nspire™ CX technology, refer to Hub Programming on TI-Nspire™ CX Technology (page 16).

The TI-Innovator™ Hub responds to TI Basic programming commands such as **Send** and **Get**.

- **Send** - Sends command strings to the Hub to control devices or request information.
- **Get** - Retrieves information requested from the Hub.
- **eval** - Supplies the result of an expression as a character string. Especially useful within the Hub command string in **Send** commands.
- **Wait** - Pauses program execution for a specified number of seconds.

Code Examples: TI CE Graphing Calculator

Desired Action	Program Code
Turn on the on-board Red LED ("LIGHT").	<code>Send("SET LIGHT ON")</code>
Play a 440Hz tone on the on-board speaker ("SOUND") for 2 seconds.	<code>Send("SET SOUND 440 TIME 2")</code>
Turn on blue element of on-board RGB LED ("COLOR") at 100% brightness.	<code>Send("SET COLOR.BLUE 255")</code>
Read and display the current value of the on-board light sensor ("BRIGHTNESS"). Range is 0% to 100%.	<code>Send("READ BRIGHTNESS")</code> <code>Get(A):Disp A</code>

Sample Program to Blink an On-Board LED

The following TI CE graphing calculator program uses the **Send** and **Wait** commands to blink the on-board red LED in the Hub. The commands are contained in a "For...End" loop that repeats the ON/OFF blink cycle for 10 iterations.

```

PRGM: BLINK
For(N,1,10)
Send("SET LIGHT ON")
Wait 1
Send("SET LIGHT OFF")
Wait 1
End

```



How to Create and Execute a Program

Note: These are abbreviated instructions. For detailed instructions on creating and executing programs, refer to *TI-Basic Programming for the TI CE Graphing Calculator*. The guide is available through the TI-Innovator™ Technology eGuide (page ii).

Before You Begin

- ▶ Refer to System Requirements (page 2), and update your calculator's OS (Operating System) and Hub App, as needed. You can update from TI Connect™ CE software or from another updated calculator.

Note: The TI-Innovator™ Hub App is available for download from the TI website at education.ti.com/latest.

To Create a New Program on TI CE Graphing Calculator:

1. On the Home Screen, press **[prgm]**, select **New**, and press **[enter]**.
2. Type a name for your program, such as "SOUNDTST," and then press **[enter]**.
The Program Editor opens, displaying a template for your program code.
3. Enter the lines of code that make up your program.
 - You must use the Hub Menu to enter TI-Basic commands, such as **Send** and **Get**. (Press **[prgm]** and select **Hub**.)
 - You can enter Hub command strings and parameters such as "**SET LIGHT ON**" by using the menu or by typing. If you type the strings, make sure to use the correct case.
 - At the end of each line, press **[enter]**. Each new line is automatically preceded by a colon (:).
 - Use the arrow keys to move through a program. Press **[del]** to delete, or press **[2nd] [ins]** to insert.

To Close the Program Editor

- ▶ Press **[2nd]** **[quit]** to return to the Home Screen.

The program remains available through the **[prgm]** key.

To Run the Program:

1. Ensure that the TI-Innovator™ Hub is connected to your calculator.
2. Ensure that any needed I/O Modules or Breadboard components are connected to the Hub.
3. From the Home Screen, press **[prgm]**, select your program name from the displayed list, and press **[enter]**.

The program name is pasted to the Home Screen.

4. Press **[enter]** again to run the program.

To Edit an Existing Program:

1. On the Home Screen, press **[prgm]**, select **Edit**.
2. Select the program name from the displayed list, and press **[enter]**.

The program opens in the Program Editor.

Using the Hub Menu to Build Commands

The Hub menu is available on the TI CE graphing calculator anytime you are creating or editing a program. It can save you time building commands and help you with correct command spelling and syntax.

Note: To build a command from the Hub menu, you need to know:

- The unique name of the component that you are addressing, such as "SOUND" for the on-board speaker.
- The command parameters that apply to the component, such as sound frequency and duration. Some parameters are optional, and you might need to know the value range of a parameter.

Example of Using the Hub Menu:

This TI CE graphing calculator example builds the command **Send** ("**SET SOUND 440 TIME 2**") to sound a 440Hz tone for 2 seconds on the on-board speaker.

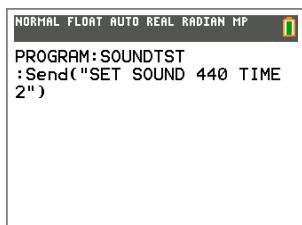

1. Open (or create) the program that you will use to communicate with the Hub.
2. Position the cursor where you want to place the command.

3. Press **[prgm]** and select **Hub**.

The Hub menu appears.

```
NORMAL FLOAT AUTO REAL RADIAN MP
CTL I/O COLOR EXEC HUB
1:Send("SET...
2:Send("READ...
3:Settings...
4:Wait
5:Get(
6:eval(
7:Send("CONNECT-Output...
8:Send("CONNECT-Input...
9↓Ports...
```

4. Select **Send "SET** and press **[enter]**, and then select **SOUND** and press **[enter]**.

```
PROGRAM: SOUNDST
:Send("SET SOUND █
```

5. Type **440** as the sound frequency.

```
PROGRAM: SOUNDST
:Send("SET SOUND 440█
```

6. On the Hub menu, select **Settings > TIME**.

```
PROGRAM: SOUNDST
:Send("SET SOUND 440 TIME
█
```

7. Type **2** as the TIME value.

```
PROGRAM: SOUNDST
:Send("SET SOUND 440 TIME
2█
```

8. To complete the command, type closing quotes (press **[alpha]** **[+]**), and then press **[]**.

```
PROGRAM: SOUNDST
:Send("SET SOUND 440 TIME
2")█
```

9. To return to the Home Screen and test the command, press **[2nd]** **[quit]** and then follow the previous instructions for running a program.

Tips for Coding with TI CE Graphing Calculator

- Make sure your code is free of unnecessary spaces that can cause syntax errors. This includes repeated spaces within the line and one or more spaces at the end of a line.
- Code from an external source might show "curly" quotation marks ("...") in places that require straight quotes ("..."). To type straight quotes, press **[alpha]** and then **[+]**.
- To clear the current line of code, press **[clear]**.
- To type relational operators such as =, <, and ≤, press **[2nd]** **[test]**.
- To type a space, press **[alpha]** and then **[0]**.
- If your program becomes unresponsive while running, press the **[on]** key.
- **Note:** If a command syntax does not include an opening left parenthesis, such as "Wait", using a pair of parentheses in an argument may be interpreted as the full argument and give an unexpected syntax error. When entering long expressions with parentheses, enclose the entire expression with paired parentheses to avoid syntax errors of this nature.

Valid: Wait ((X+4)*5)

Valid: Wait X+4*5

Syntax Error: Wait (X+4)*5

Learn More

To find sample programs and details about programming the TI-Innovator™ Hub, see the TI-Innovator™ Technology eGuide (page ii).

TI-Innovator™ Hub App for the TI CE Graphing Calculator(s)

What is the TI-Innovator™ Hub App?

The TI-Innovator™ Hub App adds the HUB menu to the programming menu on a TI CE graphing calculator.

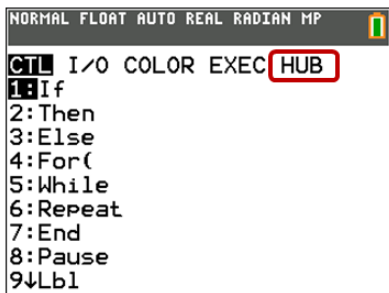

This menu option makes it easy to select commands that are commonly used when creating programs to use with the TI-Innovator™ Hub.

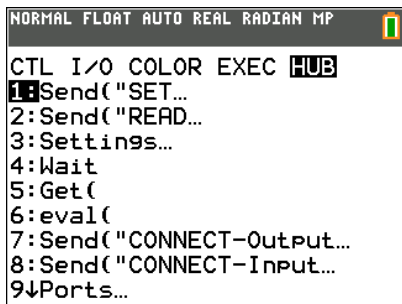

How do I know whether I have the TI-Innovator™ Hub App?

To determine if the Hub app is loaded on your TI CE graphing calculator, follow these steps.

1. Press 2nd [mem]
2. Select option "2: Mem Management/Delete..."
3. Select option "A: Apps"
4. The TI-Innovator™ Hub App is listed as "Hub" in the list of apps. Confirm that the Hub is listed.

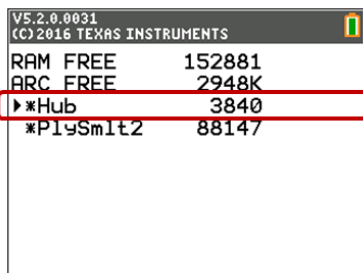

What version of the TI-Innovator™ Hub App do I need?

For best results always use the latest version of the TI-Innovator™ Hub App and TI CE Family of Graphing Calculators. Visit education.ti.com/en/product-resources/whats-new-84-ce to get the latest.

How do I know what the version number of my TI-Innovator™ Hub App is?

To determine the version of the Hub App that is loaded on your TI CE Graphing Calculator, follow these steps.

1. Press 2nd [mem]
2. Select option "2: Mem Management/Delete..."
3. Select option "A: Apps"
4. Press the down arrow until the Hub app is selected.
5. Look at the title bar to view the version number of the Hub app.

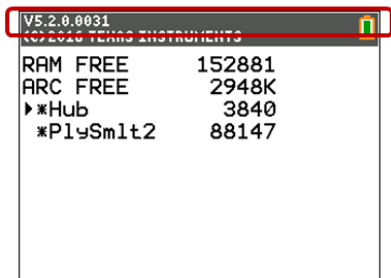

How do I get the TI-Innovator™ Hub App?

The TI-Innovator™ Hub App is available for download from the TI website at education.ti.com/latest.

Will I need to update the TI-Innovator™ Hub app every time I update the calculator OS?

The TI-Innovator™ Hub app would only need to be updated when new functionality is added to the app. However, it is strongly recommended that you always keep your TI products up to date with the latest OS and versions. When updating your OS always check to see if any apps have updates as well.

Do I need an app to use the TI-Innovator™ Hub with TI-Nspire™ CX technology?

No. TI-Nspire™ CX technology has all the commands to communicate with the TI-Innovator™ Hub built in. For best results always use the latest version of TI-Nspire™.

Hub Programming on TI-Nspire™ CX Technology

Note: These instructions apply to TI-Nspire™ CX technology. For similar instructions for TI CE graphing calculator, refer to Hub Programming on TI CE Graphing Calculator (page 8).

The TI-Innovator™ Hub responds to TI Basic programming commands such as **Send** and **Get**.

- **Send** - Sends command strings to the Hub to control devices or request information.
- **Get** and **GetStr** - Retrieve information requested from the Hub.
- **eval()** - Supplies the result of an expression as a character string. Valid only within **Send**, **Get**, and **GetStr** commands.
- **Wait** - Pauses program execution for a specified number of seconds.

Code Examples: TI-Nspire™ CX Technology

Desired Action	Program Code
Turn on the on-board Red LED ("LIGHT").	Send "SET LIGHT ON"
Play a 440Hz tone on the on-board speaker ("SOUND") for 2 seconds.	Send "SET SOUND 440 TIME 2"
Turn on blue element of on-board RGB LED ("COLOR") at 100% brightness.	Send "SET COLOR.BLUE 255"
Read and display the current value of the on-board light sensor ("BRIGHTNESS"). Range is 0% to 100%.	Send "READ BRIGHTNESS" Get a: Disp a

Sample Program to Blink an On-Board LED

The following TI-Nspire™ CX program uses the **Send** and **Wait** commands to blink the on-board red LED in the Hub. The commands are contained in a "For...EndFor" loop that repeats the ON/OFF blink cycle for 10 iterations.

```
Define blink()=  
Prgm  
For n,1,10  
  Send "SET LIGHT ON"  
  Wait 1  
  Send "SET LIGHT OFF"  
  Wait 1  
EndFor  
EndPrgm
```

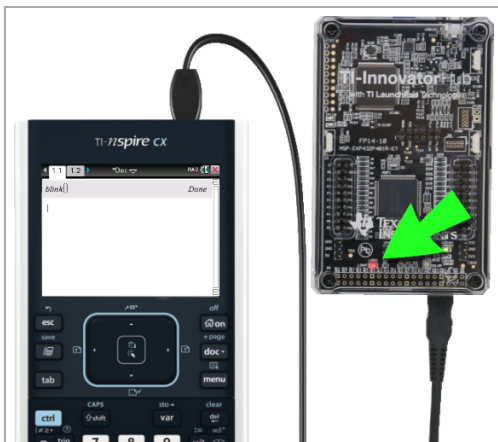

How to Create and Execute a Program

Note: These are abbreviated instructions. For detailed instructions, refer to the *TI-Nspire™ CX Program Editor*, accessible through the TI-Innovator™ Technology eGuide (page ii).

Before You Begin:

- ▶ Refer to System Requirements (page 2), and update your software as needed.
 - On TI-Nspire™ CX handhelds, use TI-Nspire™ computer software to update the Operating System.
 - On computers running TI-Nspire™ CX software, use the Help menu to update the software.

To Create a New Program in a TI-Nspire CX Document:

1. On the handheld, press **doc** and select **Insert > Program Editor > New**. From the computer software, click **Insert > Program Editor > New**.
2. Type a name for your program, such as "soundtst," select **Program** as the Type, and then click **OK**.

The Program Editor opens, displaying a template for your program code.

3. Between the **Prgm** and **EndPrgm** lines, type the lines of code that make up your program.
 - You can either type command names or insert them from the Program Editor menu.
 - After typing each line, press **Enter** to type additional code.
 - Use the arrow keys to scroll through the program.

To Store the Program:

You must store your program before you can run it.

- ▶ On the handheld, press **menu** and select **Check Syntax & Store > Check Syntax & Store**.
On the Program Editor menu, click **Check Syntax & Store > Check Syntax & Store**.

To Close the Program Editor

- ▶ On the handheld, press **menu** and select **Actions > Close**.
On the Program Editor menu, click **Actions > Close**.

If you have made changes since storing the program, you are prompted to Check Syntax & Store.

To Run the Program:

1. Ensure that the TI-Innovator™ Hub is connected to your handheld or computer.
2. Ensure that any needed I/O Modules or Breadboard components are connected to the Hub.
3. Open the document that contains the program.
4. On a Calculator page, type the program name and parentheses. If the program requires arguments, enclose them in the parentheses, separated by commas.

The program runs.

To Edit an Existing Program:

1. If necessary, open the document that contains the program.
2. Go to a Calculator page.
3. On the handheld, press **menu** and select **Functions & Programs > Program Editor > Open**.
On the Calculator menu, click **Functions & Programs > Program Editor > Open**.
4. Select the program name from the displayed list.

The program appears in a Program Editor page.

Using the Hub Menu to Build Commands

The Hub menu is available on the TI-Nspire™ CX technology anytime you are creating or editing a program. It can save you time building commands and help you with correct command spelling and syntax.

Note: To build a command from the Hub menu, you need to know:

- The unique name of the component that you are addressing, such as "SOUND" for the on-board speaker.
- The command parameters that apply to the component, such as sound frequency and duration. Some parameters are optional, and you might need to know the value range of a parameter.

Example of Using the Hub Menu:

This TI-Nspire™ CX example builds the command **Send "SET SOUND 440 TIME 2"** to sound a 440Hz tone for 2 seconds on the on-board speaker.

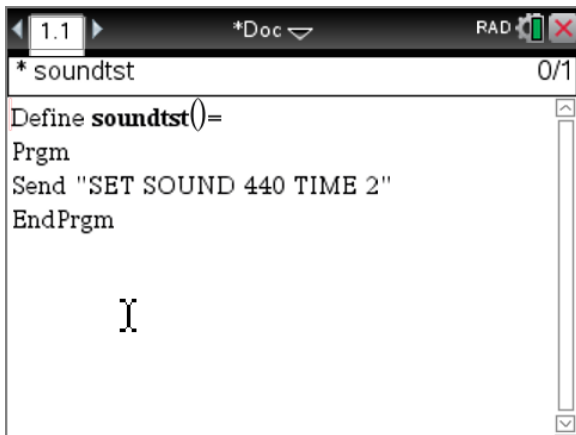

1. Open (or create) the program that you will use to communicate with the Hub.
2. Position the cursor where you want to place the command.

3. On the handheld, press **menu** and select **Hub**.
In the Program Editor menu, select **Hub**.

The Hub menu appears.

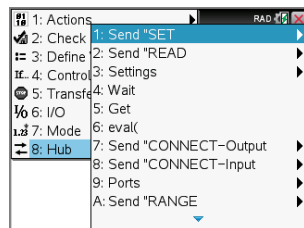

4. Select **Send "SET"**, and then select **SOUND** to insert the first part of the command.

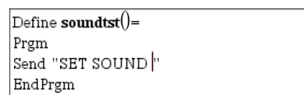



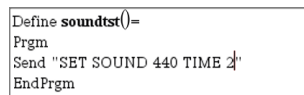
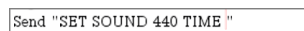
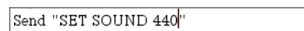





5. Type **440** as the frequency value.
6. On the Hub menu, select **Settings > TIME**.
7. To complete the command, Type **2** as the TIME value.



8. To test the command, follow the previous instructions for running a program.

Tips for Coding with TI-Nspire™ CX Technology

- Code from an external source might contain "curly" quotation marks ("...") in places that require straight quotes ("..."). To type straight quotes, press  .
- To clear the current line of code, press  .
- To type relational operators such as =, <, and ≤, press  .
- To type a space, press .
- If your program becomes unresponsive while running:

TI-Nspire™ CX Handheld: Hold down the  key and press  repeatedly.

Windows®: Hold down the **F12** key and press **Enter** repeatedly.







Mac®: Hold down the **F5** key and press **Enter** repeatedly.





Learn More

To find sample programs and details about programming the TI-Innovator™ Hub, see the TI-Innovator™ Technology eGuide (page ii).

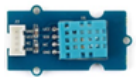
TI-Innovator™ I/O Modules

TEST These Input/Output modules (purchased separately) include cables for connecting the modules to the TI-Innovator™ Hub.

Module	Ports	Image	Sample code for TI CE Graphing Calculator
White LED *	OUT 1 OUT 2 OUT 3		Turn on the White LED module connected to OUT 1 : Send("CONNECT LED 1 TO OUT 1") Send("SET LED 1 ON")
Servo Motor **	OUT 3		Rotate the shaft of the Servo Motor connected to OUT 3 counter clockwise by 90°: Send("CONNECT SERVO 1 TO OUT 3") Send("SET SERVO 1 TO -90") Equivalent code using a variable with eval() : angdeg:=-90 Send("CONNECT SERVO 1 TO OUT 3") Send("SET SERVO 1 TO eval(angdeg)")
Analog Light Sensor	IN 1 IN 2 IN 3		Read and display ambient light level from the sensor connected to IN 2 : Send("CONNECT LIGHTLEVEL 1 TO IN2") Send("READ LIGHTLEVEL 1") Get(L):Disp(L)
Ultrasonic Ranger	IN 1 IN 2		Read and display measured distance from the ranger connected to IN 2 : Send("CONNECT RANGER 1 TO IN2") Send("READ RANGER 1") Get(R):Disp(R)
Vibration Motor	OUT 1 OUT 2 OUT 3		Turn on the Vibration Motor connected to OUT 1 : Send("CONNECT VIB.MOTOR 1 TO OUT 1") Send("SET VIB.MOTOR 1 TO ON")
Temperature Sensor	IN 1 IN 2 IN 3		Read and display the ambient temperature from the sensor connected to IN 3 : Send("CONNECT TEMPERATURE 3 TO IN3") Send("READ TEMPERATURE 3") Get(T):Disp(T)
Temperature and Humidity Sensor	IN 1 IN 2 IN 3		Connect the DHT sensor to port IN 2 Send("CONNECT DHT 1 TO IN2") Read the temperature from the DHT sensor connected to IN 2 :

Module	Ports	Image	Sample code for TI CE Graphing Calculator
			<pre>Send("READ DHT 1 TEMPERATURE") Get temperature Read the humidity from the DHT sensor: Send "READ DHT 1 HUMIDITY" Get humidity</pre>
Hall Sensor	IN 1 IN 2 IN 3		<p>Connect the Hall effect sensor to IN3 port:</p> <pre>Send "CONNECT ANALOG.IN 1 TO IN 3"</pre> <p>Read the value of the magnetic field reported by the sensor:</p> <pre>Send "READ ANALOG.IN 1" Get m</pre>
Moisture Sensor	IN 1 IN 2 IN 3		<p>Connect moisture sensor to IN 1:</p> <pre>Send "CONNECT MOISTURE 1 IN 1"</pre> <p>Configure the measurement range to be between 0 and 100. The range is an index and has no units.</p> <pre>Send "RANGE MOISTURE 1 0 100"</pre> <p>Read the sensor:</p> <pre>Send "READ MOISTURE 1" Get moisture</pre>
MOSFET	OUT 1 OUT 2		<p>Connect the MOSFET to the OUT 1 port:</p> <pre>Send "CONNECT ANALOG.OUT 1 TO OUT 1"</pre> <p>Control the connected motor/pump at 50% speed for 3 seconds:</p> <pre>Send "SET ANALOG.OUT 1 128 TIME 3"</pre>
Water Pump			It is controlled through a MOSFET module.

*The White Led module requires some assembly.

**The Servo Motor requires auxiliary power and some assembly.

Note: For details, refer to the TI-Innovator™ Technology eGuide (page ii).

Connecting an I/O Module

You use the I/O cable included with the module to connect it to a Hub Input or Output port.

1. Check the above table to ensure that you know which I/O ports support the module that you are connecting.
2. Connect either end of the I/O cable to the white connector on the module.
3. Connect the free end of the I/O cable to the Hub port you have decided to use.
4. If the module requires auxiliary power, connect the power source (page 28),

Sample Program to Blink an LED Module

The following TI CE graphing calculator program uses **Send** and **Wait** commands to blink an LED module connected to an I/O port.

Note: This program operates correctly only if the calculator is connected to the Hub and an LED module is physically connected to port **OUT 1**.

```
PRGM: BLINKIO
Send("CONNECT LED 1 TO
OUT1")
For(N,1,10)
Send("SET LED 1 ON")
Wait 1
Send("SET LED 1 OFF")
Wait 1
End
Send("DISCONNECT LED 1")
```

Note: If you are using TI-Nspire™ CX technology, omit the parentheses, and change **End** to **EndFor**.



The Hub command string "CONNECT LED 1 TO OUT1" tells the Hub that an LED module is connected to port **OUT 1** on the Hub. After sending this command, the code can address the LED as "LED 1." The CONNECT command is required only for I/O Modules and Breadboard components. It is not necessary with the on-board components such as the built-in speaker.

Learn More

For a list of precautions to take while using the I/O Modules, refer to *General Precautions* (page 31).

To find sample programs, a list of additional I/O Modules, and details about programming I/O Modules, see the TI-Innovator™ Technology eGuide (page ii).







TI-Innovator™ Breadboard Pack





The breadboard and its components (purchased separately) let you build breadboard projects and connect them to the TI-Innovator™ Hub through its Breadboard Connector pins.

The breadboard components include:

- A breadboard and jumper cables for creating electrical connections.
- Addressable components, such as LEDs and sensors, that respond to Hub commands. These are listed in the table below.
- Passive components, such as resistors, capacitors, and manual switches that are not directly addressable by the Hub but are required in many breadboard projects.
- A Battery Holder that holds four AA batteries. Batteries are not included.

Addressable Components

Component	Image	Used with pins	Description
Red LEDs		BB 1-10	Light-emitting diode that emits light when current passes through it.
Green LEDs		BB 1-10	Light-emitting diode that emits light when current passes through it.
RGB (Red-Green-Blue) LEDs		BB 8-10	Light-emitting diode with independently adjustable red, green and blue elements. Can produce a wide variety of colors.
Thermistor		BB 5,6,7 (analog input required)	Resistor whose resistance changes based on temperature. Used for measurement and control.
7-segment Display		BB 1-10	Array of LEDs arranged to display numbers and some alphabetic characters. Also has an LED for a decimal point.
Small DC Motor		BB 1-10 (uses digital to)	Motor that converts direct current electrical power into mechanical

		generate software PWM)	power.
TTL Power MOSFET		BB 1-10	Transistor used for amplifying or switching electronic signals.
TI Analog Temperature Sensor		BB 5,6,7 (analog input required)	Sensor that reports a voltage proportional to the ambient temperature within a range of -55°C to 130°C.
Visible Light Sensor		BB 5,6,7 (analog input required)	Sensor that reports the level of ambient light.
Infrared Transmitter LTE-302, yellow dot		BB 1-10 (digital output)	Side emitting Infrared LED, designed to be paired with the LTR-301 Photo-Transistor.
Infrared Receiver LTR-301, red dot		BB 1-10 (digital input)	Side sensing Infrared photo transistor, designed to be paired with the LTE-302 Infrared Emitter.

Sample Code to Blink a Breadboard LED

The following TI CE graphing calculator(s) program uses **Send** and **Wait** commands to blink a specific LED on the breadboard.

Note: This program operates correctly only if the calculator is connected to the Hub and the LED is physically connected to **BB1** (breadboard pin 1) on the Hub.

```

PRGM: BLINKBB
Send("CONNECT LED 1 TO BB1")
For(N,1,10)
Send("SET LED 1 ON")
Wait 1
Send("SET LED 1 OFF")
Wait 1
End
Send("DISCONNECT LED 1")

```

Note: If you are using TI-Nspire™ CX technology, omit the parentheses, and change **End** to **EndFor**.

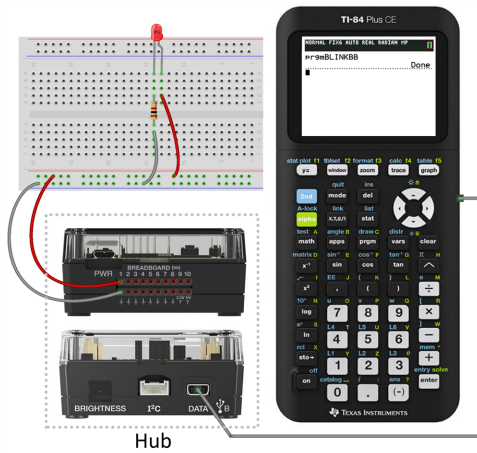

The Hub command string "CONNECT LED 1 TO BB1" tells the Hub that an LED on the breadboard is connected to pin 1 on the Hub. After sending this command, your code can address the LED as "LED 1." The CONNECT command is required only for I/O Modules and breadboard components. It does not apply to on-board components such as the built-in speaker.

Breadboard Basics

The breadboard makes it easy to connect the electronic components of a project by inserting component leads and jumper cables into pins on the breadboard.

The pins are arranged in groups of 5. The 5 pins in each group are electrically connected to each other at the back of the board. You connect leads and cables together by inserting them into pins within the same group.

- Power rails at the top and bottom are marked with red (+) and blue (–) stripes. The groups in each rail are electrically connected along the entire length of the stripe.
- The remaining 5-pin groups on the board are labeled with numbers and letters. Each group is electrically isolated from the others.

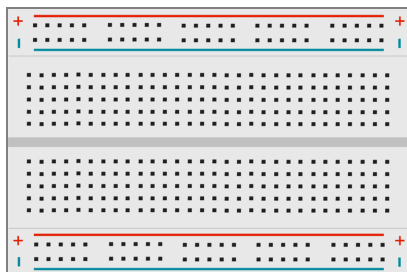

Front of board showing power rails and connection pins

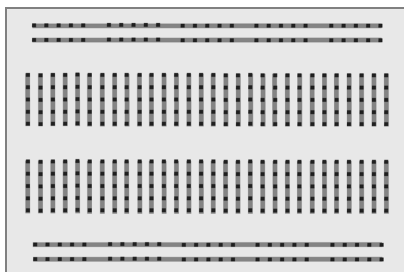

Interconnections at back of board (normally hidden). The 5-pin groups in each power rail are interconnected. All other 5-pin groups are isolated.

The gap at the center of the breadboard allows easy connection of electronic components provided as dual-inline packages.

You use jumper cables between the Hub and the breadboard to power breadboard components and to control or monitor them through program code. The Hub has 20 labeled pins, including 10 signal pins, 8 ground pins, one 3.3V power pin, and one 5.0V power pin.

Learn More

For a list of precautions to take while using the breadboard and its components, refer to *General Precautions* (page 31).

To find sample programs and details about programming breadboard components on the TI-Innovator™ Hub, see the TI-Innovator™ Technology eGuide (page ii).

Using an Auxiliary Power Source

Normally, the TI-Innovator™ Hub and its connected components draw power from the host calculator or computer, through the **DATA** connector. Certain components, such as the optional Servo Motor, require more power than a calculator can provide reliably.

The **PWR** connector on the Hub lets you connect an auxiliary power source. You can use the TI Wall Charger or the External Battery Pack.

TI Wall Charger (included with the Hub)

- Plugs into a wall outlet.
- Does not use batteries.



External Battery Pack (sold separately)

- Rechargeable.
- Has On/Off button with a row of LEDs that momentarily indicate the battery charge when you turn the battery on.
- Turns itself off after being disconnected from the Hub for about 3 minutes.



Note: To recharge the External Battery Pack, disconnect it from the Hub and then connect it to the TI Wall Charger using the USB Standard A to Micro cable. Do not use the External Battery Pack as an auxiliary power source while it is being charged.

Connecting the Power Source

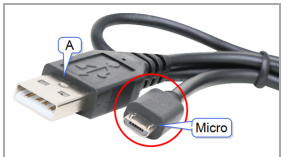
1. Identify the Micro connector on the USB Standard A to Micro auxiliary power cable.
 2. Insert the Micro connector into the **PWR** connector at the top of the Hub.
- 
- The image shows a black USB Standard A to Micro auxiliary power cable. A blue callout 'A' points to the USB Standard A connector, and a red circle highlights the Micro connector, with a blue callout 'Micro' pointing to it.
3. Insert the free end of the cable (the "A" connector) into the USB port on the power source.
 4. Turn on the power source:
 - If using the TI Wall Charger, plug it into a wall socket.
 - If using the External Battery Pack, press the power button.

An auxiliary power LED on the Hub glows to show that the Hub is receiving auxiliary power.

5. Connect the TI-Innovator™ Hub to the host calculator, using the USB Standard A to Mini-B cable.
6. Connect the I/O Module or breadboard component to the Hub.

TI-Innovator™ Hub Troubleshooting

I don't see the green LED when I connect TI-Innovator™ Hub.

- Make sure that the calculator is turned on.
- If you are using a USB Unit-to-Unit (Mini-A to Mini-B) cable to connect to a calculator, make sure to connect the "B" end of the cable to the **DATA** connector at the bottom of the Hub. Reversing this cable prevents the Hub from receiving power.
- Make sure your calculator or computer meets the System Requirements (page 2).
- Make sure the end of the USB cable connected to the calculator is inserted completely.

How do I turn the Hub off?

1. Turn off the host calculator or computer.
– OR –
Disconnect the USB cable.
2. Disconnect any auxiliary power source connected to the **PWR** port on the Hub.

Why does my program give me a syntax error?

- If you have pasted code from an external source or text editor, it might contain "curly" quotation marks ("...") in places that require straight quotes ("..."). You may need to replace some or all of the curly quotes.
- The syntax rules are slightly different between the TI CE graphing calculator and TI-Nspire™ CX technology. Code originally created for one platform may need to be modified to work on the other.
- On the TI CE graphing calculator, make sure you don't have a space character at the end of a line of code. To find these trailing spaces in a line, move the cursor to the line and press **[2nd]** **[]**. Adjacent spaces in code can also cause a syntax error.

How do I stop a program that becomes unresponsive?

- TI CE graphing calculator: Press the **[on]** key.
- TI-Nspire™ CX Handheld: Hold down the **[on]** key and press **[enter]** repeatedly.
- Windows®: Hold down the **F12** key and press **Enter** repeatedly.
- Mac®: Hold down the **F5** key and press **Enter** repeatedly.

Why do I get an error when I try to update the TI-Innovator™ Sketch?

- For sketch updating, make sure you are using the USB Standard A to Micro cable, not the USB Standard A to Mini-B cable. Connect the micro end of the cable to the **PWR** connector at the top of the Hub.
- Make sure you are using one of the Web browsers required for updating. See Updating the Hub Software (page 6).

Learn More

To find more troubleshooting information, see the TI-Innovator™ Technology eGuide (page ii).

General Precautions for the TI-Innovator™ Hub

TI-Innovator™ Hub

- Do not expose the Hub to temperatures above 140°F (60°C).
- Do not disassemble or mistreat the Hub.
- Do not chain together multiple Hubs through the I/O ports or the Breadboard Connector.
- Use only the USB cables provided with the Hub.
- Use only the TI provided power supplies:
 - TI Wall Charger included with the TI-Innovator™ Hub
 - Optional External Battery Pack
 - 4AA battery holder included in the TI-Innovator™ Breadboard Pack
- Ensure that the components receiving power from the Hub do not exceed the Hub's 1-amp power limit.
- Avoid using the Hub to control AC electricity.

Breadboard Connector on the Hub

- Do not insert the leads of LEDs and other components directly into the Hub's Breadboard Connector. Assemble the components on the breadboard and use the provided jumper cables to connect the breadboard to the Hub.
- Do not connect the 5V receptacle pin on the Hub's Breadboard Connector to any of the other pins, especially the ground pins. Doing so could damage the Hub.
- Connecting the top row of receptacle pins (BB1-10) to the bottom row (grounding and power pins) is not recommended.
- No pin on the Hub's Breadboard Connector can sink or source greater than 4 mA.

Breadboard

- Do not connect the positive and negative leads of a power source to the same group of 5 pins on the breadboard. Doing so could damage the breadboard and the power source.
- Observe the correct polarity:
 - When connecting the breadboard to the Hub.
 - When connecting components that are sensitive to polarity, such as LEDs and the TTL Power MOSFET.

I/O Modules

- Use the correct Input or Output port as required for each module.
 - Vibration Motor – supported on **OUT 1**, **OUT 2**, and **OUT 3**.
 - Servo Motor – use **OUT 3** only.

- White LED – supported on **OUT 1**, **OUT 2**, and **OUT 3**.
- Analog Light Sensor – supported on **IN 1**, **In 2**, and **IN 3**.
- Ultrasonic Ranger – supported on **IN 1**, **IN 2**.
- Use an Auxiliary Power Source for modules that require more than 50 mA, including:
 - Vibration Motor
 - Servo Motor
- Do not hold the Servo Motor’s shaft while it is rotating. Also, do not rotate the Servo Motor by hand.
- White LED:
 - Do not bend the leads repeatedly; this will weaken the wires and may cause them to break.
 - The LED requires the correct polarity when inserted into its socket. For details, refer to the instructions for assembling the LED in the TI-Innovator™ Technology eGuide (page ii).
 - The LED requires the correct polarity when inserted into its socket. For details, refer to the instructions for assembling the LED (page 281).
- No I/O module can sink or source greater than 4 mA.

TI-Innovator™ Rover

- Do not expose the Rover to temperatures above 140°F (60°C).
- Do not disassemble or mistreat the Rover.
- Do not put anything heavier than 1 Kg or 2.2 lbs on the Rover platform.
- Use only the USB cables provided with the TI-Innovator™ Hub.
- Use only the Ribbon cables provided with the Rover.
- Use only the TI provided wall charger included with the Hub.
- The front-mounted Ultrasonic Ranger will detect objects within 4 meters of the Rover. For best results make sure the object’s surface is bigger than a folder. If used to detect small objects, such as a cup, place the Rover within 1 meter of the object.
- For best results, leave the Slide Case off of your graphing calculator.
- For best performance, use Rover on the floor, not on tables. Damage may occur from Rover falling off a table.
- For best performance, use Rover on a hard surface. Carpet may cause the Rover wheels to catch or drag.
- Do not turn the Holder pegs on the Calculator Platform without lifting them first. They could break.
- Do not use the marker as a lever to pull or push the Rover.
- Do not unscrew the case enclosure on the bottom of the Rover. Encoders have sharp edges that should not be exposed.

- Do not move Rover after executing a program. The internal gyroscope may unintentionally try to get the Rover back on track using the initial location.
- When inserting the Breadboard Ribbon Cable into the Hub Breadboard Connector, it is critical that you insert the cable correctly. Make sure the red (dark) wire pin is inserted into the 5v hole on the Hub's Breadboard Connector.

Caution: If you dislodge or disconnect any of the cables, use this image as a reference for correct hookups. Reference to Bottom View

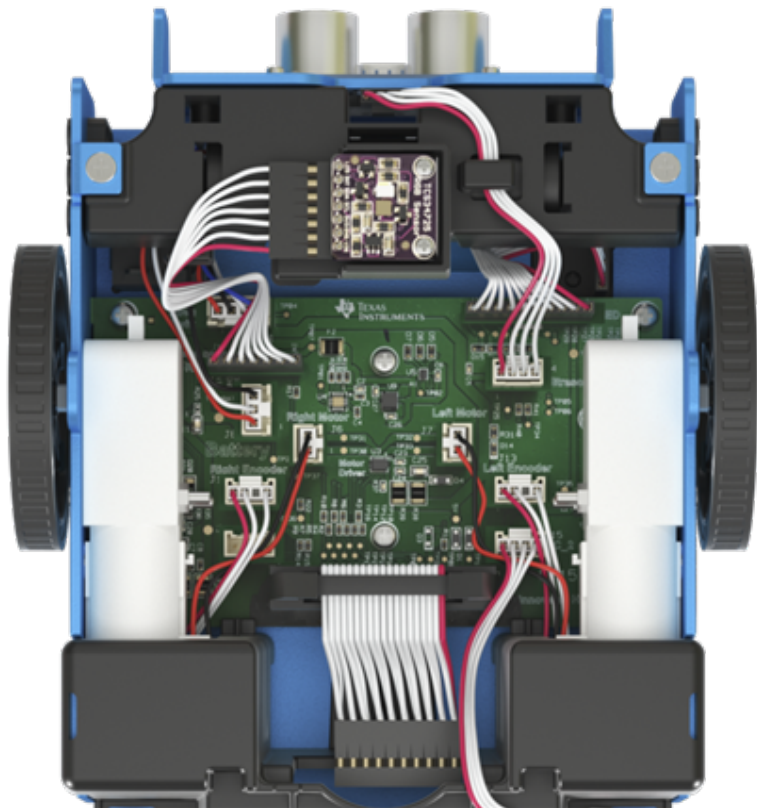

TI-Innovator™ Hub Commands Version 1.5

Use the Hub menus to create or edit a program. They can save you time building commands and help you with correct command spelling and syntax.

When you see "**Code Sample**" in a command table, this "**Code Sample**" may be copied and pasted *as is* to send to your graphing calculator to use in your calculations.

Example:

Code Sample:	<pre>Send ("RV FORWARD") Send ("RV FORWARD SPEED 0.2 M/S TIME 10")</pre>
---------------------	--

Note: To build a command from the Hub menu, you need to know:

- The unique name of the component that you are addressing, such as "SOUND" for the on-board speaker.
- The command parameters that apply to the component, such as sound frequency and duration. Some parameters are optional, and you might need to know the value range of a parameter.

Understanding Syntax

- Capitalized words are keywords
- Lower case words are placeholders for numbers
- Commands within brackets are optional parameters

For example in: SET LIGHT ON [[BLINK|TOGGLE] frequency] [[TIME] seconds], "frequency" is entered as "1" and "seconds" is entered as "10".

```
Send ("SET LIGHT 1 BLINK 2 TIME 10")
```

NOTE: The commands listed below are for CE Calculators. If you are using TI-Nspire™ CX technology the parentheses are omitted. In addition, you will notice some other minor differences in the commands such as "**Endfor**" instead of "**End**" with the TI-Nspire™ CX technology. Screenshots are provided for reference. **Note:** Actual menus may vary slightly from provided images.

Last Menu Entry

Notice the last menu entries. These allow you to type in the name of the object instead of selecting it from the menu. These can also be used for sensors and peripherals that are not explicitly included in the menus. To use these, select the menu item to paste the beginning of the command. You then type in the name of the sensor or device you are using.

Last Menu Entry	CE Calculators	TI-Nspire™ CX
-----------------	----------------	---------------

– Send("SET

```
NORMAL FLOAT AUTO REAL RADIAN HP
Send("SET
I: AVERAGING
J: BBPORT
K: Send("SET
```



– Send("READ

```
NORMAL FLOAT AUTO REAL RADIAN HP
Send("READ
I: BBPORT
J: Send("READ
```



– Send("CONNECT

```
NORMAL FLOAT AUTO REAL RADIAN HP
Send("CONNECT
0: SWITCH
A: BUTTON
B: MOTION
C: POTENTIOMETER
D: THERMISTOR
E: RGB
F: LOUDNESS
G: BBPORT
H: Send("CONNECT
```



– Send("DISCONNECT

```
NORMAL FLOAT AUTO REAL RADIAN HP
Send("DISCONNECT
6: ANALOG_OUT
7: VIB_MOTOR
8: BUZZER
9: RELAY
0: SERVO
A: SQUAREWAVE
B: DIGITAL_OUT
C: BBPORT
D: Send("DISCONNECT
```

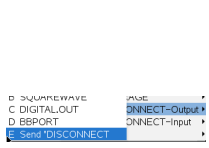

HUB Menus

- Send("SET...
- Send("READ...
- Settings
- Wait
- Get(
- eval(
- Rover (RV)...
- Send("CONNECT-Output...
- Send("CONNECT-Input...
- Ports...
- Send("RANGE...
- Send("AVERAGE...
- Send("DISCONNECT-Output...
- Send("DISCONNECT-Input...
- Manage...
- Collect...

CE Calculators

```
NORMAL FLOAT AUTO REAL RADIAN HP
CTL I/O COLOR EXEC HUB
1: Send("SET...
2: Send("READ...
3: SettIngs...
4: Wait
5: Get(
6: eval(
7: Rover (RV)
8: Send("CONNECT-Output...
9: Send("CONNECT-Input...
```

```
0: Ports...
A: Send("RANGE...
B: Send("AVERAGE...
C: Send("DISCONNECT-Output...
D: Send("DISCONNECT-Input...
E: Manage...
```

TI-Nspire™ CX

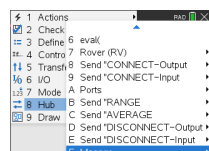
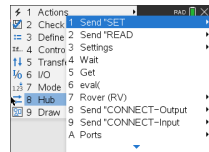

Send("SET...

- SET
 - LIGHT
 - COLOR
 - SOUND
 - LED
 - RGB
 - SPEAKER
 - POWER
 - SERVO.CONTINUOUS
 - ANALOG.OUT
 - VIB.MOTOR
 - COLOR.RED
 - COLOR.GREEN
 - COLOR.BLUE
 - BUZZER
 - RELAY
 - SERVO
 - SQUAREWAVE
 - DIGITAL.OUT
 - AVERAGING
 - BBPORT
 - Send("SET

CE Calculators

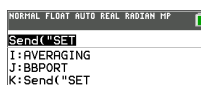

TI-Nspire™ CX

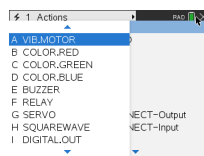
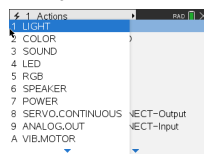

Additional Set Commands

Send("READ...

- READ
 - BRIGHTNESS
 - DHT
 - RANGER
 - LIGHTLEVEL
 - TEMPERATURE
 - MOISTURE
 - MAGNETIC
 - VERNIER
 - ANALOG.IN

CE Calculators

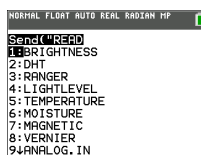

TI-Nspire™ CX

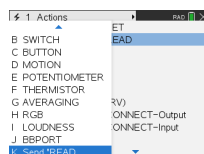
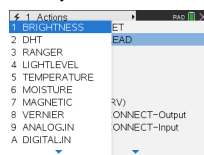

- DIGITAL.IN
- SWITCH
- BUTTON
- MOTION
- POTENTIOMETER
- THERMISTOR
- AVERAGING
- RGB
- LOUDNESS
- BBPORT
- TIMER
- Send("READ

```
NORMAL FLOAT AUTO REAL RADIAN MP
Send("READ
1:BBPORT
J:Send("READ
```

Additional READ Commands

Settings...

- Settings
 - ON
 - OFF
 - TO
 - TIME
 - BLINK
 - TEMPERATURE
 - HUMIDITY
 - CW
 - CCW
 - NAMED
 - PULLDOWN
 - INPUT
 - PH
 - FORCE10
 - FORCE50
 - PRESSURE
 - PRESSURE2

CE Calculators

```
NORMAL FLOAT AUTO REAL RADIAN MP
Settings
1:ON
2:OFF
3:TO
4:TIME
5:BLINK
6:TEMPERATURE
7:HUMIDITY
8:CW
9:CCW
```

```
NORMAL FLOAT AUTO REAL RADIAN MP
Settings
9:CCW
0:NAMED
R:PULLDOWN
B:INPUT
C:PH
D:FORCE10
E:FORCE50
F:PRESSURE
G:PRESSURE2
```

TI-Nspire™ CX

```
1 Actions
2 OFF
3 TO
4 TIME
5 BLINK
6 TEMPERATURE
7 HUMIDITY
8 CW
9 CCW
A NAMED
```

```
1 Actions
2 OFF
3 TO
4 TIME
5 BLINK
6 TEMPERATURE
7 HUMIDITY
8 CW
9 CCW
A NAMED
B PULLDOWN
C INPUT
D PH
E FORCE10
F FORCE50
G PRESSURE
H PRESSURE2
```

Wait

CE Calculators

TI-Nspire™ CX

- Wait

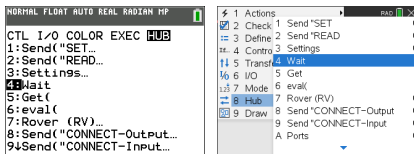

Get(

- Get(

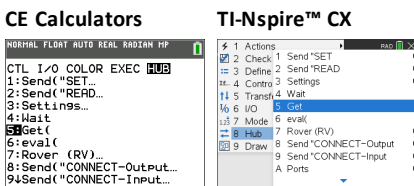

eval(

- eval(

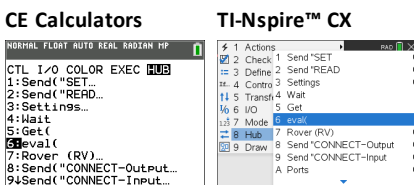

Rover (RV)...

- Drive RV...
- Read RV Sensors...
- RV Settings...
- Read RV Path...
- RV Color...
- RV Setup...
- RV Control...
- Send "CONNECT RV"
- Send "DISCONNECT RV"

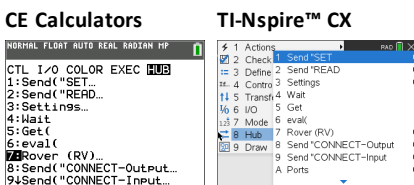

Send("CONNECT-Output...

- CONNECT-Output
 - LED
 - RGB
 - SPEAKER
 - POWER

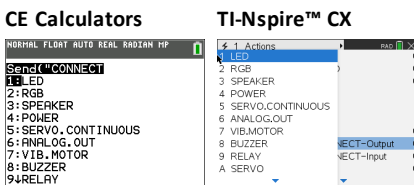

- SERVO.CONTINUOUS
- DCMOTOR
- ANALOG.OUT
- VIB.MOTOR
- BUZZER
- RELAY
- SERVO
- SQUAREWAVE
- DIGITAL.OUT
- BBPORT
- Send("CONNECT

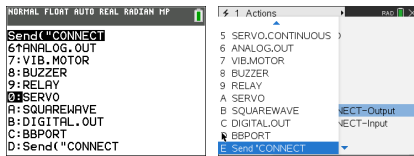

- LIGHT
- COLOR
- SOUND

Send("CONNECT-Input...

- CONNECT-Input
 - DHT
 - RANGER
 - LIGHTLEVEL
 - TEMPERATURE
 - MOISTURE
 - MAGNETIC
 - VERNIER
 - ANALOG.IN
 - DIGITAL.IN
 - SWITCH
 - BUTTON
 - MOTION
 - POTENTIOMETER
 - THERMISTOR
 - RGB
 - LOUDNESS
 - BBPORT
 - Send("CONNECT

CE Calculators

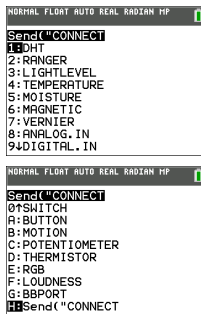

TI-Nspire™ CX

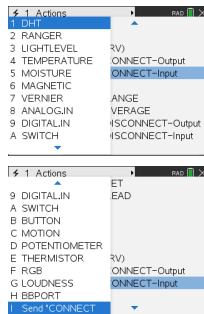

- BRIGHTNESS

Ports...

- Ports
 - OUT 1
 - OUT 2
 - OUT 3
 - IN 1
 - IN 2
 - IN: 3
 - I2C
 - BB 1
 - BB 2
 - BB 3
 - BB 4
 - BB 5
 - BB 6
 - BB 7
 - BB 8
 - BB 9
 - BB 10
 - BBPORT

CE Calculators

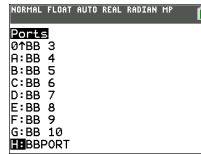
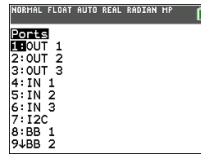

TI-Nspire™ CX

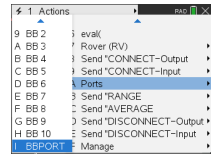
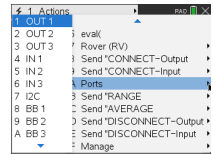

Send("RANGE...

- RANGE
 - BRIGHTNESS
 - LOUDNESS
 - LIGHTLEVEL
 - TEMPERATURE
 - POTENTIOMETER
 - MOISTURE
 - THERMISTOR
 - ANALOG.IN

CE Calculators

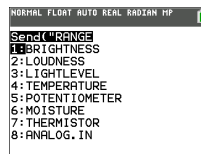

TI-Nspire™ CX

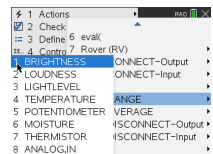

Send("AVERAGE...

CE Calculators

TI-Nspire™ CX

- **AVERAGE**

- BRIGHTNESS
- LOUDNESS
- LIGHTLEVEL
- TEMPERATURE
- POTENTIOMETER
- MOISTURE
- THERMISTOR
- ANALOG.IN

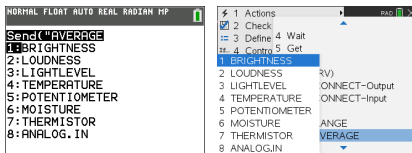

Additional **AVERAGE** Commands

Send("DISCONNECT-Output...

- **DISCONNECT-Output...**
 - LED
 - RGB
 - SPEAKER
 - POWER
 - SERVO.CONTINUOUS
 - DCMOTOR
 - ANALOG.OUT
 - VIB.MOTOR
 - BUZZER
 - RELAY
 - SERVO
 - SQUAREWAVE
 - DIGITAL.OUT
 - BBPORT
 - Send("DISCONNECT
 - LIGHT
 - COLOR
 - SOUND

CE Calculators



TI-Nspire™ CX

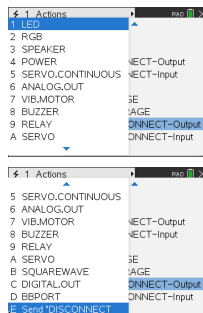

Send("DISCONNECT-Input...

- **DISCONNECT-Input...**
 - DHT

CE Calculators

TI-Nspire™ CX

- RANGER
- LIGHTLEVEL
- TEMPERATURE
- MOISTURE
- MAGNETIC
- VERNIER
- ANALOG.IN
- DIGITAL.IN
- SWITCH
- BUTTON
- MOTION
- POTENTIOMETER
- THERMISTOR
- RGB
- LOUDNESS
- BBPORT
- Send("DISCONNECT
- BRIGHTNESS

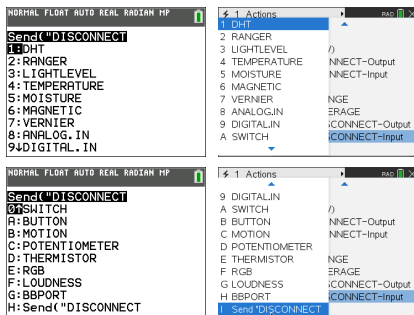

MANAGE

- MANAGE
 - BEGIN
 - ISTI
 - WHO
 - WHAT
 - HELP
 - VERSION
 - ABOUT

CE Calculators

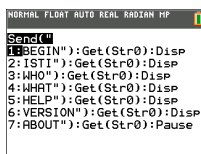

TI-Nspire™ CX

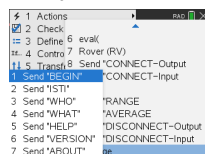

COLLECT

- COLLECT
 - COLLECT
 - READ_COLLECT

CE Calculators

TI-Nspire™ CX

Additional Supported Commands Not Found in the Hub Menu

- Additional **SET** Commands
 - FORMAT ERROR STRING/NUMBER
 - FORMAT ERROR NOTE/QUIET
 - FLOW [TO] ON/OFF
 - OUT1/2/3 [TO]
-

- Additional **READ** Commands
 - ANALOG.OUT
 - BUZZER
 - COLOR
 - RED
 - GREEN
 - BLUE
 - DCMOTOR i
 - DIGITAL.OUT i
 - FORMAT
 - FLOW
 - IN1/IN2/IN3
 - LAST ERROR
 - LED i
 - LIGHT
 - OUT1/2/3
 - PWR
 - RELAY i
 - RESOLUTION
 - RGB i
 - RED i
 - GREEN i
 - BLUE i
 - SERVO i
 - SERVO i CALIBRATION
 - SOUND
 - SPEAKER i
 - SQUAREWAVE i
-

- Additional **AVERAGE** Commands

- PERIOD
-

- Additional **CALIBRATE** Commands

- CALIBRATE
 - SERVO i minimum maximum
 - TEMPERATURE i c1 c2 c3 r
 - THERMISTOR i c1 c2 c3 r
-

SET

The **SET** command is used to generate outputs on pins or ports, or control output devices such as LEDs, Servo motors, speaker tones, or other output operations. It is also used to control a variety of system settings. These include formatting of error information, and communications flow control. **SET** does NOT generate any response that requires reading. The success or failure of a **SET** command may be determined by sending a **READ LAST ERROR** command and obtaining the response to that command. The sensors, controls, and settings that **SET** can operate against are in the following table.

SET something'

Command:	SET
Command Syntax:	SET
Code Sample:	
Range:	
Describe:	Used to set options, or output states, or provide information used to control an external actuator or output device, such as turning on a RELAY .
Result:	
Type or Addressable Component:	

CE Calculators

```
NORMAL FLOAT AUTO REAL RADIAN MP
Send("SET")
1: LIGHT
2: COLOR
3: SOUND
4: LED
5: RGB
6: SPEAKER
7: POWER
8: SERVO, CONTINUOUS
9: ANALOG, OUT
```

```
NORMAL FLOAT AUTO REAL RADIAN MP
Send("SET")
0: VIB. MOTOR
A: COLOR, RED
B: COLOR, GREEN
C: COLOR, BLUE
D: BUZZER
E: RELAY
F: SERVO
G: SQUAREWAVE
H: DIGITAL, OUT
```

```
NORMAL FLOAT AUTO REAL RADIAN MP
Send("SET")
I: AVERAGING
J: BBPORT
K: Send("SET")
```

TI-Nspire™ CX

```
← 1 Actions
1 LIGHT
2 COLOR
3 SOUND
4 LED
5 RGB
6 SPEAKER
7 POWER
8 SERVO, CONTINUOUS SECT-Output
9 ANALOG, OUT SECT-Input
A VIB. MOTOR
```

```
← 1 Actions
A VIB. MOTOR
B COLOR, RED
C COLOR, GREEN
D COLOR, BLUE
E BUZZER
F RELAY
G SERVO SECT-Output
H SQUAREWAVE SECT-Input
I DIGITAL, OUT
```

```
J AVERAGING SECT-Input
K BBPORT
L Send("SET")
```

LIGHT [TO] ON/OFF

Command:	LIGHT [TO] ON/OFF
Command Syntax:	SET LIGHT ON [[BLINK TOGGLE] frequency] [[TIME] seconds] SET LIGHT OFF - same as LED , but for on-board red LED .
Range:	
Describe:	Provides control over the on-board digital RED LED . Set optional blink frequency and duration. SET LIGHT ON [[BLINK TOGGLE] frequency] [[TIME] seconds] SET LIGHT OFF
Result:	Turns on LIGHT . Turns off LIGHT
Type or Addressable Component:	Control

COLOR [TO] r g b [[BLINK | TOGGLE] frequency] [[TIME] seconds]

Command:	COLOR [TO] r g b [[BLINK TOGGLE] frequency] [[TIME] seconds]
Command Syntax:	SET COLOR r g b [[BLINK TOGGLE] frequency] [[TIME]seconds] SET COLOR.component x [[BLINK TOGGLE] frequency] [[TIME]seconds]
Range:	
Describe:	On-board COLOR RGB LED with sub-components .RED , .GREEN , .BLUE . Can have a blink frequency, and blink time for entire item, or for each component individually, as well as PWM levels given individually, or at one time.
Result:	Where r g b is r-value g-value b-value respectively, or operators from ON/OFF/UP/DOWN/STOP .
Type or Addressable Component:	Control

See Also:

SOUND [TO] frequency [[TIME] seconds]

Command:	SOUND [TO] frequency [[TIME] seconds]
Command Syntax:	SET SOUND frequency [[TIME] seconds]
Range:	
Describe:	SOUND is the on-board speaker and can generate a sound with a specified frequency. If not specified, sound will play for 1 second default. SET SOUND frequency [[TIME] seconds]
Result:	Play tone through on-board speaker.
Type or Addressable Component:	Control

TEMPO keyword for SOUND/SPEAKER

- Quick way to add repeated beeps
- Equivalent to “blink” for **SOUND**
- New optional keyword – **TEMPO**

```
SET SOUND 440 TEMPO 2 TIME 2
```

- 2 beeps per second for 2 seconds: total 4 beeps
- The value for **TEMPO** can range from 0 to 10

Code Sample:	SET SOUND 440 TEMPO 2 TIME 5 SET SPEAKER 1 880 TEMPO 3 TIME 4
	SET SOUND 400 TIME 5 TEMPO 0 is equivalent to SET SOUND 400 TIME 5 Both commands will play the tone for 5 seconds without any breaks.

SOUND OFF/0

Command:	SOUND OFF/0
Command Syntax:	SET SOUND 0
Range:	
Describe:	SOUND is the on-board speaker and can generate a sound with a specified frequency. If not specified, sound will play for 1 second default. SET SOUND 0 – turns off sound on internal speaker immediately.
Result:	Stop playing sound.
Type or Addressable Component:	Control

LED i [TO] ON/OFF

Command:	LED i [TO] ON/OFF
Command Syntax:	SET LED i ON/ OFF [[BLINK TOGGLE] frequency] [[TIME] seconds] – digital LED (on or off only)
Range:	
Describe:	Provides control over an external LED to set optional blink frequency and duration, as well as PWM capability if the associated pin connected to the LED supports it. SET LED i ON [[BLINK TOGGLE] frequency] [[TIME] seconds] – digital LED (on or off only) SET LED i OFF – turns off LED (same as SET LED i 0).
Result:	Turns on LED. Turns off LED When connected to an Analog-PWM pin.
Type or Addressable Component:	Control

LED i [TO] 0-255

Command:	LED i [TO] 0-255
Command Syntax:	SET LED i 0-255 [[BLINK TOGGLE] frequency] [[TIME] seconds] – analog LED (pwm duty cycle)
Range:	
Describe:	Provides control over an external LED to set optional blink frequency and duration, as well as PWM capability if the associated pin connected to the LED supports it. SET LED i 0-255 [[BLINK TOGGLE] frequency] [[TIME] seconds] – analog LED (pwm duty cycle)
Result:	When connected to an Analog-PWM pin.
Type or Addressable Component:	Control

RGB i [TO] r g b [[BLINK | TOGGLE] frequency] [[TIME] seconds]

Command:	RGB i [TO] r g b [[BLINK TOGGLE] frequency] [[TIME] seconds]
Command Syntax:	SET RGB i r g b [[BLINK TOGGLE] frequency] [[TIME]seconds]
Range:	
Describe:	External RGB LED controls, with same options as available for the on-board COLOR object. Individual color components can be addressed with the same index value i by name, RED i, GREEN i, BLUE i.
Result:	Where r g b is r-value g-value b-value respectively, or operators from ON/OFF/STOP.
Type or Addressable Component:	Control

COLOR.RED i [TO] ON/OFF/UP/DOWN/value [[BLINK | TOGGLE] frequency] [[TIME] seconds]

Command:	COLOR.RED i [TO] ON/OFF/UP/DOWN/value [[BLINK TOGGLE] frequency] [[TIME] seconds]
Command Syntax:	SET COLOR.RED i [TO] ON/OFF/UP/DOWN/value [[BLINK TOGGLE] frequency] [[TIME] seconds]
Range:	
Describe:	RED component of External RGB LED controls, with same options as available for the on-board COLOR object. Individual color components can be addressed with the same index value i by name, RED i, GREEN i, BLUE i.
Result:	
Type or Addressable Component:	Control

COLOR.GREEN i [TO] ON/OFF/UP/DOWN/value [[BLINK | TOGGLE] frequency] [[TIME] seconds]

Command:	COLOR.GREEN i [TO] ON/OFF/UP/DOWN/value [[BLINK TOGGLE] frequency] [[TIME] seconds]
Command Syntax:	SET COLOR.GREEN i [TO] ON/OFF/UP/DOWN/value [[BLINK TOGGLE] frequency] [[TIME] seconds]
Range:	
Describe:	GREEN component of External RGB LED controls, with same options as available for the on-board COLOR object. Individual color components can be addressed with the same index value i by name, RED i, GREEN i, BLUE i.
Result:	
Type or Addressable Component:	Control

COLOR.BLUE i [TO] ON/OFF/UP/DOWN/value [[BLINK | TOGGLE] frequency] [[TIME] seconds]

Command:	COLOR.BLUE i [TO] ON/OFF/UP/DOWN/value [[BLINK TOGGLE] frequency] [[TIME] seconds]
Command Syntax:	SET COLOR.BLUE i [TO] ON/OFF/UP/DOWN/value [[BLINK TOGGLE] frequency] [[TIME] seconds]
Range:	
Describe:	BLUE component of External RGB LED controls, with same options as available for the on-board COLOR object. Individual color components can be addressed with the same index value i by name, RED i, GREEN i, BLUE i.
Result:	
Type or Addressable Component:	Control

Note: For TI-RGB Array commands, please go to TI-RGB Array.

SPEAKER i [TO] frequency [[TIME] seconds]

Command:	SPEAKER i [TO] frequency [[TIME] seconds]
Command Syntax:	SET SPEAKER i [TO] frequency [[TIME] seconds]
Range:	
Describe:	Same as SOUND above, except sound is played on an external speaker attached to a digital output pin, available on any IN/OUT port, or the breadboard connector port. Note: On-board SOUND and external SPEAKER cannot be used concurrently.
Result:	Play tone with frequency given, optional duration in milliseconds, default = 1 second.
Type or Addressable Component:	Control

TEMPO keyword for SOUND/SPEAKER

- Quick way to add repeated beeps
- Equivalent to “blink” for **SOUND**
- New optional keyword – **TEMPO**

```
SET SOUND 440 TEMPO 2 TIME 2
```

- 2 beeps per second for 2 seconds: total 4 beeps
- The value for **TEMPO** can range from 0 to 10

Code Sample:	SET SOUND 440 TEMPO 2 TIME 5 SET SPEAKER 1 880 TEMPO 3 TIME 4
	SET SOUND 400 TIME 5 TEMPO 0 is equivalent to SET SOUND 400 TIME 5 Both commands will play the tone for 5 seconds without any breaks.

POWER

Command:	POWER i [TO] 0-100
Command Syntax:	SET POWER 1 n where n is the intensity of the output from 0 - 100 SET POWER 1 50 – set the power to 50% of the maximum.
Range	0 – 100
Describe:	POWER is used to control the output power and it typically used with a MOSFET and a battery source. It can be used to control the output to devices like a motor or a pump.
Result:	Controls the output intensity of the device connected through the MOSFET .
Type or Addressable Component:	Control

SERVO i [TO] position

Command:	SERVO i [TO] position
Command Syntax:	SET SERVO i [TO] position.
Code Sample:	
Range:	
Describe:	Servo motor control interface. Servos can be either continuous or sweep style servos. Position = value from -90 to 90, ranged to -90 to 90) - used with SWEEP SERVOS
Result:	Sweep servos: position is a value from -90 to 90. Value 0 is same as specifying ZERO .
Type or Addressable Component:	Control

SERVO i [TO] STOP

Command:	SERVO i [TO] STOP
Command Syntax:	SET SERVO i STOP
Code Sample:	<code>Send("SET SERVO 1 STOP")</code>
Range:	
Describe:	Servo motor control interface. Servos can be either continuous or sweep style servos. Note: Sweep style servos will stop automatically at the end of the sweep. SET SERVO i STOP – stops motion on servo
Result:	Halt any continuous servo operation in progress. Turn SERVO Off
Type or	Control

Command:	SERVO i [TO] STOP
Addressable Component:	

SERVO i [TO] ZERO

Command:	SERVO i [TO] ZERO
Command Syntax:	SET SERVO i ZERO/position
Code Sample:	<code>Send("SET SERVO 1 ZERO")</code>
Range:	
Describe:	Set servo to zero position on sweep servo, or no motion on continuous servo.
Result:	Sweep servos: position is a value from -90 to 90. Value 0 is same as specifying ZERO .
Type or Addressable Component:	Control

SERVO i [TO] [CW/CCW] speed [[TIME] seconds]

Command:	SERVO i [TO] [CW/CCW] speed [[TIME] seconds]
Command Syntax:	SET SERVO i CW/CCW speed [[TIME] seconds]
Code Sample:	<code>Send("SET SERVO.CONTINUOUS 1 CW 100 TIME 3")</code> <code>Wait 3</code>
Range:	
Describe:	Speed from -100 to 100, CW/CCW optional, if speed <0, CCW , else CW unless CW/CCW keyword is specified,

Command:	SERVO i [TO] [CW/CCW] speed [[TIME] seconds]
	TIME optional, in seconds, default=1 second (for continuous servo operation) (CW/CCW required if TIME/seconds NOT specified.)
Result:	Continuous servo where direction of rotation is specified, along with speed, from 0 (no motion) to 100 (fastest). Optional time parameter used to specify how long the servo should rotate in seconds.
Type or Addressable Component:	Control

ANALOG.OUT i [TO]

Command:	ANALOG.OUT i [TO]
Command Syntax:	SET ANALOG.OUT i 0-255 [[BLINK TOGGLE] frequency] [[TIME] seconds]
Range:	
Describe:	Software (or hardware, if available) generated pulse-width modulation output at 490 Hz with the specified duty cycle between 0 (off) and 255 (on). The PWM output can be toggled at a frequency from 0.1 to 20.0 Hz for a given duration. If no duration is given, the PWM continues until stopped or turned off. SET ANALOG.OUT i 0-255 [[BLINK TOGGLE] frequency] [[TIME] seconds]
Result:	Generate pwm value (hw or sw) on analog output object.
Type or Addressable Component:	Control

ANALOG.OUT i OFF | STOP

Command:	ANALOG.OUT i OFF STOP
Command Syntax:	SET ANALOG.OUT i OFF SET ANALOG.OUT i STOP
Range:	

Command:	ANALOG.OUT i OFF STOP
Describe:	Software (or hardware, if available) generated pulse-width modulation output at 490 Hz with the specified duty cycle between 0 (off) and 255 (on). The PWM output can be toggled at a frequency from 0.1 to 20.0 Hz for a given duration. If no duration is given, the PWM continues until stopped or turned off. SET ANALOG.OUT i OFF SET ANALOG.OUT i STOP
Result:	Turn off pwm on associated pin, including blinking, etc.
Type or Addressable Component:	Control

VIB.MOTOR i [TO] PWM

Command:	VIB.MOTOR i [TO] PWM
Command Syntax:	SET VIB.MOTOR i [TO] PWM
Range:	PWM from 0 (none) and 255 (full on)
Describe:	Vibration motor control interface.
Result:	Vibrations : intensity is a value from 0 to 255.
Type or Addressable Component:	Control

VIB.MOTOR i [TO] OFF | STOP

Command:	VIB.MOTOR i [TO] OFF STOP
Command Syntax:	SET VIB.MOTOR i OFF STOP
Range:	
Describe:	Vibration motor control interface. SET VIB.MOTOR i OFF STOP – stops motion on vibrations

Command:	VIB.MOTOR i [TO] OFF STOP
Result:	Shut down vibration motor.
Type or Addressable Component:	Control

VIB.MOTOR i [TO] 0-255/UP/DOWN/ON/OFF [[BLINK | TOGGLE] freq] [[TIME] seconds]

Command:	VIB.MOTOR i [TO] 0-255/UP/DOWN/ON/OFF [[BLINK TOGGLE] freq] [[TIME] seconds]
Command Syntax:	SET VIB.MOTOR i 0-255/UP/DOWN/ON/OFF [[BLINK TOGGLE] freq] [[TIME] seconds]
Range:	PWM from 0 (none) and 255 (full on)
Describe:	Run vibration motor with numerous options
Result:	Run vibration motor with numerous options Optional time parameter used to specify how long the vibration should rotate in seconds.
Type or Addressable Component:	Control

COLOR.RED [TO] r [[BLINK | TOGGLE] frequency] [[TIME] seconds]

Command:	COLOR.RED [TO] r [[BLINK TOGGLE] frequency] [[TIME] seconds]
Command Syntax:	Send("SET COLOR.RED...") ON/OFF/UP/DOWN/STOP/0-255 (red element) [BLINK frequency] (in Hz) [TIME duration] (in secs)
Range:	
Describe:	RED component of On-board COLOR RGB LED . Can have a blink frequency, and blink time for entire item, or for each component

Command:	COLOR.RED [TO] r [[BLINK TOGGLE] frequency] [[TIME] seconds]
	individually, as well as PWM levels given individually, or at one time.
Result:	Where r is red level, or operators from ON/OFF/UP/DOWN/STOP.
Type or Addressable Component:	Control

COLOR.GREEN [TO] g [[BLINK | TOGGLE] frequency] [[TIME] seconds]

Command:	COLOR.GREEN [TO] g [[BLINK TOGGLE] frequency] [[TIME] seconds]
Command Syntax:	SET COLOR.GREEN [TO] g [[BLINK TOGGLE] frequency] [[TIME] seconds]
Range:	
Describe:	GREEN component of On-board COLOR RGB LED . Can have a blink frequency, and blink time for entire item, or for each component individually, as well as PWM levels given individually, or at one time.
Result:	Where g is green level, or operators from ON/OFF/UP/DOWN/STOP.
Type or Addressable Component:	Control

COLOR.BLUE [TO] b [[BLINK | TOGGLE] frequency] [[TIME] seconds]

Command:	COLOR.BLUE [TO] b [[BLINK TOGGLE] frequency] [[TIME] seconds]
Command Syntax:	SET COLOR.BLUE [TO] b [[BLINK TOGGLE] frequency] [[TIME] seconds]
Range:	
Describe:	BLUE component of On-board COLOR RGB LED . Can have a blink frequency, and blink time for entire item, or for each component individually, as well as PWM levels given individually, or at one time.

Command:	COLOR.BLUE [TO] b [[BLINK TOGGLE] frequency] [[TIME] seconds]
Result:	Where b is blue level, or operators from ON/OFF/UP/DOWN/STOP.
Type or Addressable Component:	Control

BUZZER i [TO] ON [TIME seconds]

Command:	BUZZER i [TO] ON [TIME seconds]
Command Syntax:	SET BUZZER i ON [[TIME] seconds]
Range:	
Describe:	Used to turn ON or OFF a tone on an active BUZZER for either 1 second default, or given length of time. SET BUZZER i ON [[TIME] seconds]
Result:	Sound tone on ACTIVE buzzer for 1 second, or specified duration in seconds.
Type or Addressable Component:	Control

BUZZER i [TO] OFF

Command:	BUZZER i [TO] OFF
Command Syntax:	SET BUZZER i OFF
Range:	
Describe:	Used to turn ON or OFF a tone on an active BUZZER for either 1 second default, or given length of time. SET BUZZER i OFF
Result:	Turn off tone on active buzzer.
Type or Addressable Component:	Control

RELAY i [TO] ON/OFF

Command:	RELAY i [TO] On/Off
Command Syntax:	SET RELAY i ON/OFF /0/1 [[TIME] seconds].
Range:	Turns the specified RELAY ON or OFF for the given specified TIME in seconds.
Describe:	Control interface to an external RELAY control. SET RELAY i ON/OFF/1/0 [[TIME] seconds]
Result:	Turns RELAY on or off
Type or Addressable Component:	Control RELAY

SQUAREWAVE i [TO] frequency [duty [[TIME] seconds]]

Command:	SQUAREWAVE i [TO] frequency [duty [[TIME] seconds]]
Command Syntax:	SET SQUAREWAVE i frequency [duty]
Range:	
Describe:	SQUAREWAVE is used to generate a square wave form with a default duty cycle of 50% with frequencies from 0.1 Hz to 500 Hz. frequencies slower than 0.1 Hz are set to 0.1 Hz. frequencies above 500 Hz are set to 500 Hz. The optional duty cycle is a value from 1 to 99. SET SQUAREWAVE i frequency [duty]
Result:	Generate a digital squarewave from 1 to 500 hz at 1-99 duty cycle on up to 6 pins (i=1-4) duty=50% default, seconds=1.0 default.
Type or Addressable Component:	Control

SQUAREWAVE i OFF

Command:	SQUAREWAVE i OFF
Command Syntax:	SET SQUAREWAVE i OFF frequency [duty]
Range:	
Describe:	SQUAREWAVE is used to generate a square wave form with a default duty cycle of 50% with frequencies from 0.1 Hz to 500 Hz. frequencies slower than 0.1 Hz are set to 0.1 Hz. frequencies above 500 Hz are set to 500 Hz. The optional duty cycle is a value from 1 to 99. SET SQUAREWAVE i OFF – turn off squarewave generation
Result:	Stop generating squarewave output.
Type or Addressable Component:	Control

DIGITAL.OUT i [TO] ON/OFF/HIGH/LOW/[BLINK | TOGGLE] frequency] [[TIME] seconds]

Command:	DIGITAL.OUT i [TO] ON/OFF/HIGH/LOW/[BLINK TOGGLE] frequency] [[TIME] seconds]
Command Syntax:	SET DIGITAL.OUT i [TO] ON/OFF/HIGH/LOW [[BLINK TOGGLE] frequency] [[TIME] seconds]
Range:	
Describe:	Used to generate output digital signal(s). SET DIGITAL.OUT i ON/OFF/HIGH/LOW [[BLINK TOGGLE] frequency] [[TIME] seconds]
Result:	Digital.out operations.
Type or Addressable Component:	Control

DIGITAL.OUT i [TO] OUTPUT/CLOCK

Command:	DIGITAL.OUT i [TO] OUTPUT/CLOCK
Command Syntax:	SET DIGITAL.OUT i [TO] OUTPUT/CLOCK
Range:	
Describe:	Output or drive a clock pulse - digital.out other operations.
Result:	Output or drive a clock pulse - digital.out other operations.
Type or Addressable Component:	Control

DIGITAL.IN i [TO] INPUT/PULLUP/PULLDOWN

Command:	DIGITAL.IN i [TO] INPUT/PULLUP/PULLDOWN
Command Syntax:	SET DIGITAL.IN i [TO] INPUT/PULLUP/PULLDOWN
Range:	
Describe:	Used for Pulldown and/or pullup control for digital.in operations.
Result:	Pulldown and pullup control for digital.in operations.
Type or Addressable Component:	Control

AVERAGING [TO] n

Command:	AVERAGING [TO] n
	Advanced user
Command Syntax:	AVERAGING.[TO] n
Range:	
Describe:	Global setting for how many times we sample analog inputs when

Command:	AVERAGING [TO] n Advanced user
	obtaining a reading from a sensor using analog input n - (global default)
Result:	Sample analog inputs 'n' times, averaging results (default is 3 unless changed; sets "global" averaging value.)
Type or Addressable Component:	Setting Default if not set with this command is 3
Note:	<p>Global averaging value can be individually overridden by sensor by using the AVERAGE command on an item.</p> <p>This command sets the global averaging count to use only on newly connected objects. This does not affect already CONNECTED objects.</p> <p>AVERAGE object (index) value sets/changes the averaging count to use on an already connected object.</p> <p>The global AVERAGING value set by the SET AVERAGING operation will not take effect on an object until is disconnected and reconnected. The global initial default is 3 samples per reading. Once an object is connected, the AVERAGE command can be used to change the value.</p>

BBPORT

Command:	SET BBPORT [TO] nn [MASK value]
Command Syntax:	SET BBPORT TO 100 SET BBPORT TO 0X80
Range	
Describe:	The SET operation on BBPORT is used to set the respective bits of the BB port to a 1 or 0 value based on the value given, the optional MASK (which is used to specify which pins are being used as digital outputs) and the internal connection mask specified in the CONNECT BBPORT operation.
Result:	
Type or Addressable Component:	Control

READ

The **READ** command generates responses based on what is being requested.

Tells the Innovator to obtain data from the specified sensor, control, port, pin, or status information including the setup of the hub, such as flow control, error settings, etc. Must be followed by a Get() operation to receive the requested data.

CE Calculators

```
NORMAL FLOAT AUTO REAL RADIAN MP
Send("READ")
1: BRIGHTNESS
2: DHT
3: RANGER
4: LIGHTLEVEL
5: TEMPERATURE
6: MOISTURE
7: MAGNETIC
8: VERNIER
9: ANALOG.IN
```

```
NORMAL FLOAT AUTO REAL RADIAN MP
Send("READ")
0: DIGITAL.IN
A: SWITCH
B: BUTTON
C: MOTION
D: POTENTIOMETER
E: THERMISTOR
F: AVERAGING
G: RGB
H: LOUDNESS
```

```
NORMAL FLOAT AUTO REAL RADIAN MP
Send("READ")
I: BBPORT
J: Send("READ")
```

TI-Nspire™ CX

```
1: Actions
2: BRIGHTNESS
3: DHT
4: LIGHTLEVEL
5: TEMPERATURE
6: MOISTURE
7: MAGNETIC
8: VERNIER
9: ANALOG.IN
A: DIGITAL.IN
```

```
1: Actions
B: SWITCH
C: BUTTON
D: MOTION
E: POTENTIOMETER
F: THERMISTOR
G: AVERAGING
H: RGB
I: LOUDNESS
J: BBPORT
K: Send("READ")
```

BRIGHTNESS

Command:	BRIGHTNESS
Command Syntax:	READ BRIGHTNESS
Range:	
Describe:	Returns the current internal reading from the on-board ambient light sensor. Note the optional keywords of RANGE and AVERAGE can be appended to the command to return the current RANGE setting for the BRIGHTNESS sensor if set or the current AVERAGE value applied when reading the ADC to obtain the reading. READ BRIGHTNESS
Result:	Read on-board light sensor level.
Type or	Control

Command:	BRIGHTNESS
Addressable Component:	

BRIGHTNESS AVERAGE

Command:	BRIGHTNESS AVERAGE Advanced user
Command Syntax:	READ BRIGHTNESS.AVERAGE
Range:	
Describe:	Returns the current internal reading from the on-board ambient light sensor. Note the optional keywords of RANGE and AVERAGE can be appended to the command to return the current RANGE setting for the BRIGHTNESS sensor if set or the current AVERAGE value applied when reading the ADC to obtain the reading. READ BRIGHTNESS AVERAGE
Result:	Read on-board light sensor level.
Type or Addressable Component:	Control

BRIGHTNESS RANGE

Command:	BRIGHTNESS RANGE Advanced user
Command Syntax:	READ BRIGHTNESS.RANGE
Range:	
Describe:	Returns the current internal reading from the on-board ambient light sensor. Note the optional keywords of RANGE and AVERAGE can be

Command:	BRIGHTNESS RANGE	Advanced user
	appended to the command to return the current RANGE setting for the BRIGHTNESS sensor if set or the current AVERAGE value applied when reading the ADC to obtain the reading. READ BRIGHTNESS RANGE	
Result:	Read on-board light sensor level.	
Type or Addressable Component:	Control	

DHT i

Command:	DHT i
Command Syntax:	READ DHT i
Range:	Temperature reading default is in Celsius Humidity reading from 0 to 100 %
Describe:	<p>Returns a list consisting of the current temperature, humidity, type of sensor, and last cached read status. The temperature and humidity can be obtained by themselves by appending the TEMPERATURE or HUMIDITY keywords to the end of the command. The type of sensor is indicated by a 1 for a DHT11, and a 2 for DHT22 style sensors. The status values are: 1=OK, 2=Timeout, 3=Checksum/bad reading.</p> <p>READ DHT i – returns full cached information from last reading the DHT task obtained.</p> <p>READ DHT i TEMPERATURE – returns latest temperature reading.</p> <p>READ DHT i HUMIDITY – returns latest humidity reading.</p> <p>READ DHT n TYPE - return the sensor type used (1=DHT11, 2=DHT22).</p> <p>READ DHT n STATUS - return the current status of the sensor readings provided. (1=OK, 2=Timeout, 3=Checksum error).</p>
Result:	<p>Return list with current temperature in C, humidity in %, type (1=DHT11, 2=DHT22), and status (type/status only available in full list).</p> <p>Where the status = 1:OK, =2:Timeout, =3:Checksum.</p>

Command:	DHT i
Type or Addressable Component:	Sensor

DHT i TEMPERATURE

Command:	DHT i TEMPERATURE
Command Syntax:	READ DHT i TEMPERATURE
Range:	Temperature reading default is in Celsius Humidity reading from 0 to 100 %
Describe:	<p>Returns a list consisting of the current temperature, humidity, type of sensor, and last cached read status. The temperature and humidity can be obtained by themselves by appending the TEMPERATURE or HUMIDITY keywords to the end of the command. The type of sensor is indicated by a 1 for a DHT11, and a 2 for DHT22 style sensors. The status values are: 1=OK, 2=Timeout, 3=Checksum/bad reading.</p> <p>READ DHT i – returns full cached information from last reading the DHT task obtained.</p> <p>READ DHT i TEMPERATURE – returns latest temperature reading.</p> <p>READ DHT i HUMIDITY – returns latest humidity reading.</p> <p>READ DHT n TYPE - return the sensor type used (1=DHT11, 2=DHT22).</p> <p>READ DHT n STATUS - return the current status of the sensor readings provided. (1=OK, 2=Timeout, 3=Checksum error).</p>
Result:	Returns temperature component.
Type or Addressable Component:	Sensor

DHT i HUMIDITY

Command:	DHT i HUMIDITY
Command Syntax:	READ DHT i HUMIDITY
Range:	Temperature reading default is in Celsius Humidity reading from 0 to 100 %
Describe:	Returns a list consisting of the current temperature, humidity, type of sensor, and last cached read status. The temperature and humidity can be obtained by themselves by appending the TEMPERATURE or HUMIDITY keywords to the end of the command. The type of sensor is indicated by a 1 for a DHT11, and a 2 for DHT22 style sensors. The status values are: 1=OK, 2=Timeout, 3=Checksum/bad reading. READ DHT i – returns full cached information from last reading the DHT task obtained. READ DHT i TEMPERATURE – returns latest temperature reading. READ DHT i HUMIDITY – returns latest humidity reading. READ DHT n TYPE - return the sensor type used (1=DHT11, 2=DHT22). READ DHT n STATUS - return the current status of the sensor readings provided. (1=OK, 2=Timeout, 3=Checksum error).
Result:	Returns humidity component.
Type or Addressable Component:	Sensor

RANGER i

Command:	RANGER i
Command Syntax:	READ RANGER i
Range:	
Describe:	Return the current distance measurement from the specified ultrasonic ranging device; distance in meters. If no measurement is made due to the distance being too far; a value of 0 will be returned.

Command:	RANGER i
	Valid measurements are in +meters.
Result:	Read distance in meters from distance sensor.
Type or Addressable Component:	Sensor

READ RANGER i TIME

Command:	READ RANGER i TIME
Command Syntax:	READ RANGER i TIME
Range:	
Describe:	Additional functionality for RANGER - to return time of flight instead of distance. The value is in seconds. And it is the round trip time for the signal.
Result:	Retrieves the time-of-flight data readings for the specified RANGER .
Type or Addressable Component:	Sensor

LIGHTLEVEL i

Command:	LIGHTLEVEL i
Command Syntax:	READ LIGHTLEVEL i
Range:	An integer value between 0 and 16383 (14 bit resolution)
Describe:	Returns the current ADC value from the specified external light sensor. External light sensors may be analog, or I2C (BH1750FVI I2C Light sensor). When an analog sensor is present, it is generally assumed to be a photodiode.

Command:	LIGHTLEVEL i
	<p>Additionally, the light level sensor may have AVERAGE and/or RANGE values specified. These can be obtained by appending the AVERAGE or RANGE keywords to the READ command.</p> <p>READ LIGHTLEVEL i READ LIGHTLEVEL i AVERAGE READ LIGHTLEVEL i RANGE</p>
Result:	Read analog value of light sensor (uses averaging), or I2C (value in LUX returned).
Type or Addressable Component:	Sensor

LIGHTLEVEL i AVERAGE

Command:	LIGHTLEVEL i AVERAGE	Advanced user
Command Syntax:	READ LIGHTLEVEL i AVERAGE	
Range:	An integer value between 0 and 16383 (14 bit resolution)	
Describe:	<p>Returns the current ADC value from the specified external light sensor. External light sensors may be analog, or I2C (BH1750FVI I2C Light sensor). When an analog sensor is present, it is generally assumed to be a photodiode.</p> <p>Additionally, the light level sensor may have AVERAGE and/or RANGE values specified. These can be obtained by appending the AVERAGE or RANGE keywords to the READ command.</p> <p>READ LIGHTLEVEL i AVERAGE</p>	
Result:	Read analog value of light sensor (uses averaging), or I2C (value in LUX returned).	
Type or Addressable Component:	Sensor	

LIGHTLEVEL i RANGE

Command:	LIGHTLEVEL i RANGE Advanced user
Command Syntax:	READ LIGHTLEVEL i RANGE
Range:	An integer value between 0 and 16383 (14 bit resolution)
Describe:	Returns the current ADC value from the specified external light sensor. External light sensors may be analog, or I2C (BH1750FVI I2C Light sensor). When an analog sensor is present, it is generally assumed to be a photodiode. Additionally, the light level sensor may have AVERAGE and/or RANGE values specified. These can be obtained by appending the AVERAGE or RANGE keywords to the READ command. READ LIGHTLEVEL i RANGE
Result:	Read analog value of light sensor (uses averaging), or I2C (value in LUX returned).
Type or Addressable Component:	Sensor

TEMPERATURE i

Command:	TEMPERATURE i
Command Syntax:	READ TEMPERATURE i
Range:	Temperature reading default is in Celsius. The range depends on the specific temperature sensor being used. Humidity reading from 0 to 100 %
Describe:	Returns the current temperature reading from the associated temperature sensor. The temperature is given, by default, in Celsius. READ TEMPERATURE i
Result:	Return current temperature reading in Celsius.
Type or Addressable Component:	Sensor

TEMPERATURE i AVERAGE

Command:	TEMPERATURE i AVERAGE Advanced user
Command Syntax:	READ TEMPERATURE i AVERAGE
Range:	Temperature reading default is in Celsius. The range depends on the specific temperature sensor being used. Humidity reading from 0 to 100 %
Describe:	Returns the current temperature reading from the associated temperature sensor. The temperature is given, by default, in Celsius. READ TEMPERATURE i AVERAGE
Result:	Return current temperature reading in Celsius.
Type or Addressable Component:	Sensor

TEMPERATURE i CALIBRATION

Command:	TEMPERATURE i CALIBRATION Advanced user
Command Syntax:	READ TEMPERATURE i CALIBRATION
Range:	Temperature reading default is in Celsius. The range depends on the specific temperature sensor being used. Humidity reading from 0 to 100 %
Describe:	Returns the current temperature reading from the associated temperature sensor. The temperature is given, by default, in Celsius.
Result:	Returns list with current {c1,c2,c3,r} values used for connected analog temperature sensor.
Type or Addressable Component:	Sensor

MOISTURE i

Command:	MOISTURE i
Command Syntax:	READ MOISTURE i
Range:	An integer value between 0 and 16383 (14 bit resolution)
Describe:	Return the current analog level reported by the moisture sensor specified. Supports the AVERAGE and RANGE options. READ MOISTURE i READ MOISTURE i AVERAGE READ MOISTURE i RANGE
Result:	Read analog value of moisture sensor (uses averaging).
Type or Addressable Component:	Sensor

MOISTURE i AVERAGE

Command:	MOISTURE i AVERAGE Advanced user
Command Syntax:	READ MOISTURE i AVERAGE
Range:	
Describe:	Return the current analog level reported by the moisture sensor specified. Supports the AVERAGE and RANGE options. READ MOISTURE i AVERAGE
Result:	Read analog value of moisture sensor (uses averaging).
Type or Addressable Component:	Sensor

MOISTURE i RANGE

Command:	MOISTURE i RANGE
Command Syntax:	READ MOISTURE i RANGE
Range:	
Describe:	Return the current analog level reported by the moisture sensor specified. Supports the AVERAGE and RANGE options. READ MOISTURE i RANGE
Result:	Read analog value of moisture sensor (uses averaging).
Type or Addressable Component:	Sensor

MAGNETIC

Command:	MAGNETIC i
Command Syntax:	READ MAGNETIC i
Range	0 or 1 0 – no magnetic field is detected 1 – magnetic field is detected
Describe:	The MAGNETIC sensor is used to detect the presence of a magnetic field. It uses the Hall effect. It is also known as a Hall effect sensor.
Result:	
Type or Addressable Component:	Sensor

VERNIER

Command:	READ VERNIER i
Command Syntax:	READ VERNIER 1
Range	Depends on the specific Vernier analog sensor connected to the TI-SensorLink
Describe:	Reads the value from the sensor specified in the command.
Result:	
Type or Addressable Component:	Sensor

ANALOG.IN i

Command:	ANALOG.IN i
Command Syntax:	READ.ANALOG.IN i
Range:	
Describe:	Generic analog input sensor. READ ANALOG.IN i – will return the ADC reading on the analog input associated with the object.
Result:	Reads generic ANALOG.IN input object
Type or Addressable Component:	Sensor

ANALOG.IN i AVERAGE

Command:	ANALOG.IN i AVERAGE Advanced user
Command Syntax:	READ.ANALOG.IN i AVERAGE
Range:	

Command:	ANALOG.IN i AVERAGE Advanced user
Describe:	READ ANALOG IN i AVERAGE – gets the current averaging value for the object.
Result:	Reads generic ANALOG.IN input object
Type or Addressable Component:	Sensor

ANALOG.IN i RANGE

Command:	ANALOG.IN i RANGE Advanced user
Command Syntax:	READ.ANALOG.IN i RANGE
Range:	
Describe:	READ ANALOG IN i RANGE – returns the upper and lower range values associated with the object if specified, or error otherwise
Result:	Reads generic ANALOG.IN input object
Type or Addressable Component:	Sensor

ANALOG.OUT i

Command:	ANALOG.OUT i
Command Syntax:	READ ANALOG.OUT i
Range:	
Describe:	Returns current PWM duty cycle if the output is on, or 0 if not on.
Result:	Reads current PWM duty cycle on pin, 0 if none.
Type or Addressable Component:	Control

DIGITAL.IN i

Command:	DIGITAL.IN i
Command Syntax:	READ DIGITAL.IN i
Range:	
Describe:	Returns the current state of the digital pin connected to the DIGITAL object, or the cached state of the digital output value last SET to the object.
Result:	Return 0 (low), 1 (high).
Type or Addressable Component:	Control/Sensor

SWITCH i

Command:	SWITCH i
Command Syntax:	READ SWITCH i
Range:	
Describe:	Returns the current state of the associated switch. If the switch is connected, a value of 1 is returned. Not connected returns a value of 0. If the switch was connected since the last reading, but is no longer connected, a value of 2 is returned. READ SWITCH i
Result:	Returns state of switch (same status as BUTTON object, 0=not pressed, 1=pressed, 2=was pressed).
Type or Addressable Component:	Sensor

BUTTON i

Command:	BUTTON i
Command Syntax:	READ BUTTON i
Range:	
Describe:	Reads the current cached state of the button. A return value of 0 = <i>not pressed</i> , 1 = <i>currently pressed</i> , 2 = <i>was pressed</i> and released since the last reading. READ BUTTON i
Result:	Read state of button/switch n - 0=not pressed, 1=pressed, 2=was pressed.
Type or Addressable Component:	Sensor

MOTION i

Command:	MOTION i
Command Syntax:	READ MOTION i
Range:	
Describe:	Return the current PIR Motion sensor information. PIR Motion sensors are digital in nature, so are treated similar to a button in that the value returned indicates motion presence or not. 0=no motion detected. 1=motion detected. 2=motion was detected.
Result:	Read state of PIR Motion detector - 0=no motion, 1=motion, 2=motion was detected but none now.
Type or Addressable Component:	Sensor

POTENTIOMETER i

Command:	POTENTIOMETER i
Command Syntax:	READ POTENTIOMETER i
Range:	
Describe:	Read analog value of the potentiometer (linear or rotary). The optional AVERAGE and RANGE keywords can be appended to the command to obtain the current average count, or mapped range being used, if present, for the given potentiometer. READ POTENTIOMETER i READ POTENTIOMETER i RANGE READ POTENTIOMETER i AVERAGE
Result:	Read analog value of rotary encoder / potentiometer (uses averaging).
Type or Addressable Component:	Sensor

POTENTIOMETER i AVERAGE

Command:	POTENTIOMETER i AVERAGE Advanced user
Command Syntax:	READ POTENTIOMETER i AVERAGE
Range:	
Describe:	Read analog value of the potentiometer (linear or rotary). The optional AVERAGE and RANGE keywords can be appended to the command to obtain the current average count, or mapped range being used, if present, for the given potentiometer. READ POTENTIOMETER i AVERAGE
Result:	Read analog value of rotary encoder / potentiometer (uses averaging).
Type or Addressable Component:	Sensor

Command:	POTENTIOMETER i AVERAGE	Advanced user
Component:		

POTENTIOMETER i RANGE

Command:	POTENTIOMETER i RANGE	Advanced user
Command Syntax:	READ POTENTIOMETER i RANGE	
Range:		
Describe:	Read analog value of the potentiometer (linear or rotary). The optional AVERAGE and RANGE keywords can be appended to the command to obtain the current average count, or mapped range being used, if present, for the given potentiometer. READ POTENTIOMETER i RANGE	
Result:	Read analog value of rotary encoder / potentiometer (uses averaging).	
Type or Addressable Component:	Sensor	

THERMISTOR i

Command:	THERMISTOR i	
Command Syntax:	READ THERMISTOR i	
Range:		
Describe:	Returns the current temperature reading from the associated thermistor sensor. Temperature is returned in Celsius.	
Result:	Return current thermistor temperature in Celsius.	

Command:	THERMISTOR i
Type or Addressable Component:	Sensor

THERMISTOR i AVERAGE

Command:	THERMISTOR i AVERAGE Advanced user
Command Syntax:	READ THERMISTOR i AVERAGE
Range:	
Describe:	Returns the current temperature reading from the associated thermistor sensor. Temperature is returned in Celsius.
Result:	Return current thermistor temperature in Celsius.
Type or Addressable Component:	Sensor

THERMISTOR i CALIBRATION

Command:	THERMISTOR i CALIBRATION Advanced user
Command Syntax:	READ THERMISTOR i CALIBRATION
Range:	
Describe:	Returns the current temperature reading from the associated thermistor sensor. Temperature is returned in Celsius.
Result:	Returns list with current {c1,c2,c3,r} values used for connected thermistor.
Type or	Sensor

Command:	THERMISTOR i CALIBRATION
	Advanced user
Addressable Component:	

AVERAGING

Command:	AVERAGING
	Advanced user
Command Syntax:	READ AVERAGING
Range:	
Describe:	Returns the current global setting for the analog averaging default value.
Result:	Return current oversampling/averaging count for sampling analog inputs (this is the GLOBAL default value currently in use).
Type or Addressable Component:	Setting

LOUDNESS i

Command:	LOUDNESS i
Command Syntax:	READ LOUDNESS i
Range:	
Describe:	Return the current analog level reported by the sound loudness level sensor specified. Supports the AVERAGE and RANGE options. READ LOUDNESS i READ LOUDNESS i AVERAGE

Command:	LOUDNESS i
	READ LOUDNESS i RANGE
Result:	Return level of sound detected by sound sensor.
Type or Addressable Component:	Sensor

LOUDNESS i AVERAGE

Command:	LOUDNESS i Advanced user
Command Syntax:	READ LOUDNESS i AVERAGE
Range:	
Describe:	Return the current analog level reported by the sound loudness level sensor specified. Supports the AVERAGE and RANGE options. READ LOUDNESS i AVERAGE
Result:	Return level of sound detected by sound sensor.
Type or Addressable Component:	Sensor

LOUDNESS i RANGE

Command:	LOUDNESS i RANGE Advanced user
Command Syntax:	READ LOUDNESS i.RANGE
Range:	
Describe:	Return the current analog level reported by the sound loudness level sensor specified. Supports the AVERAGE and RANGE options. READ LOUDNESS i

Command:	LOUDNESS i RANGE Advanced user
	READ LOUDNESS i AVERAGE READ LOUDNESS i RANGE
Result:	Return level of sound detected by sound sensor.
Type or Addressable Component:	Sensor

BBPORT

Command:	READ BBPORT
Command Syntax:	READ BBPORT [MASK value] Get B
Range	
Describe:	Reads the connected pins of the BBPORT object as inputs, switching pins from output state to input state. The default connection mask limits the pins that are used in this operation, as does the optional MASK value provided.
Result:	
Type or Addressable Component:	Sensor

TIMER

Command:	TIMER
Command Syntax:	READ TIMER
Code Sample:	<pre>While getKey() <> "esc" Send "READ BRIGHTNESS" Get b Send "READ TIMER" Get t Disp "Brightness: ", b, "Timer: ", t Wait 1 EndWhile</pre>
Range	
Describe:	This is a built-in sensor. There is no need for CONNECT or DISCONNECT . The Timer is set to 0 at power up. It will increase monotonically.
Result:	
Type or Addressable Component:	Sensor

Settings

Settings menu contains operations to set the state of digital and analog pin operations such as the LED in the TI-Innovator™ Hub or a connected servo motor movement to states such as ON, OFF, CW (clockwise), and CCW (counterclockwise).

- 1: ON
- 2: OFF
- 3: TO
- 4: TIME
- 5: BLINK
- 6: TEMPERATURE
- 7: HUMIDITY
- 8: CW
- 9: CCW
- 0: NAMED
- A: PULLDOWN
- B: INPUT
- C: PH
- D: FORCE10
- E: FORCE50
- F: PRESSURE
- G: PRESSURE2

CE Calculators

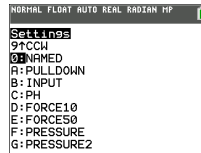
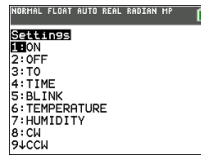

TI-Nspire™ CX

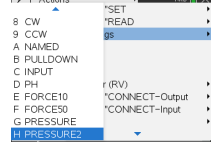
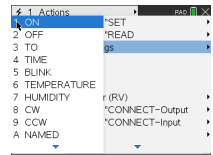

Wait

Wait suspends execution of a program for a given time. Maximum time is 100 seconds. During the wait time, the busy indicator is on in the top-right corner of the screen.

Wait may be used in TI-Innovator™ Hub programs to allow time for sensor or control communications prior to the program executing the next command line.

CE Calculators

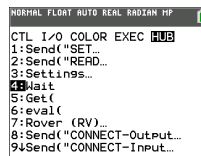

TI-Nspire™ CX

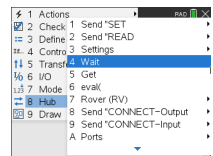

Wait

Command:	Wait
Command Syntax:	Wait <i>timeInSeconds</i> Suspends execution for a period of <i>timeInSeconds</i> seconds.
Range	0 through 100
Describe:	<p>Wait may be used in TI-Innovator™ Hub programs to allow time for sensor or control communications prior to the program executing the next command line.</p> <p>Wait is particularly useful in a program that needs a brief delay to allow requested data to become available.</p> <p>The argument <i>timeInSeconds</i> must be an expression that simplifies to a decimal value in the range 0 through 100. The command rounds this value up to the nearest 0.1 seconds.</p> <p>Note: You can use the Wait command within a user-defined program but not within a function.</p>
Result:	Wait suspends execution of a program for a given time. Maximum time is 100 seconds. During the wait time, the busy indicator is on in the top-right corner of the screen.
Type or Addressable Component:	Not Applicable

Get()

Get() Retrieves a value from a connected TI-Innovator™ Hub and stores the data to a variable on the receiving CE calculator.

CE Calculators

Get() command definition is specific to the TI-8x calculator and the cable connection via DBus or USB. The CE calculator is USB connectivity only and here, **Get()** is designed for communication with the TI-Innovator™ Hub.

TI-Nspire™ CX

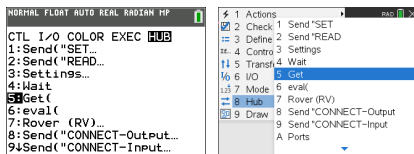

Get{

Command:	Get{
Command Syntax:	<p>CE Calculators:</p> <p>Get(<i>variable</i>)</p> <p>TI-Nspire™ CX platform:</p> <p>Get [<i>promptString</i>,] <i>var</i> [, <i>statusVar</i>]</p> <p>Get [<i>promptString</i>,] <i>func</i>(<i>arg1</i>, ...<i>argn</i>) [, <i>statusVar</i>]</p>
Range	
Describe:	
Result:	<p>Programming command: Retrieves a value from a connected TI-Innovator™ Hub and assigns the value to variable <i>var</i>. The value must be requested:</p> <ul style="list-style-type: none"> In advance, through a Send "READ ..." command. — or — By embedding a "READ ..." request as the optional <i>promptString</i> argument. This method lets you use a single command to request the value and retrieve it. (TI-Nspire™ CX platform only). <p>Implicit simplification takes place. For example, a received string of "123" is interpreted as a numeric value.</p> <p>The information below applies only on the TI-Nspire CX platform:</p> <p>To preserve the string, use GetStr instead of Get.</p> <p>If you include the optional argument <i>statusVar</i>, it is assigned a value based on the success of the operation. A value of zero means that no data was received.</p> <p>In the second syntax, the <i>func()</i> argument allows a program to store the received string as a function definition. This syntax operates as if the program executed the command:</p> $\text{Define } func(arg1, \dots, argn) = \text{received string}$

Command:	Get()
	The program can then use the defined function <i>func()</i> . Note: You can use the Get command within a user-defined program but not within a function.
Type or Addressable Component:	All input devices.

eval()

The software evaluates expression *Expr* and replaces the **eval()** statement with the result as a character string.

The argument *Expr* must simplify to a real number.

CE Calculators

```

NORMAL FLOAT AUTO REAL RADIAN MP
CTL I/O COLOR EXEC HUB
1:Send("SET...
2:Send("READ...
3:Settings...
4:Wait
5:Get()
6:eval(
7:Rover (RV)...
8:Send("CONNECT-Output...
9:Send("CONNECT-Input...

```

TI-Nspire™ CX

```

1 Actions
2 Check 1 Send "SET
3 Define 2 Send "READ
4 Contro 3 Settings
5 Transf 4 Wait
6 JO 5 Get
7 Mode 6 eval
8 Hub 7 Rover (RV)
9 Draw 8 Send "CONNECT-Output
A Ports 9 Send "CONNECT-Input

```

eval()

Command:	eval()
Command Syntax:	eval(<i>Expr</i>) ⇒ string
Range	
Describe:	<p>The software evaluates expression <i>Expr</i> and replaces the eval() statement with the result as a character string.</p> <p>The argument <i>Expr</i> must simplify to a real number.</p> <p>CE Calculators: eval() can be used as a standalone command outside a TI-Innovator™ Hub command.</p> <p>TI-Nspire™ CX platform: eval() is valid only in the TI-Innovator™ Hub Command argument of programming commands Get, GetStr, and Send.</p>

Command:	eval()
Result:	<p>CE Calculators: For debugging purposes, using the command line <code>Disp Ans</code> immediately after a command line using <code>Send()</code> displays the complete string being sent.</p> <p>TI-Nspire™ CX platform: Although <code>eval()</code> does not display its result, you can view the resulting Hub command string after executing the command by inspecting any of the following special variables.</p> <p><i>iostr.SendAns</i></p> <p><i>iostr.GetAns</i></p> <p><i>iostr.GetStrAns</i></p>
Type or Addressable Component:	Not Applicable

CONNECT-Output

CONNECT associates a given control or sensor with a pin or port on the TI-Innovator. If the specified control or sensor is currently in use, an error will be generated. If the pin or port specified in the **CONNECT** command is currently in use, an error will be generated.

The **CONNECT** command does not generate an active response, but a variety of errors may occur during a connection attempt, such as pin-in-use, unsupported, invalid options, bad options, etc.

CONNECT 'something i' [TO] IN1/IN2/IN3/OUT1/OUT2/OUT3/BB1

Command:	CONNECT
Command Syntax:	CONNECT
Range:	
Describe:	Associates a sensor or control with a given port or pin(s). Places the respective pin(s) in use
Result:	
Type or Addressable Component:	

CE Calculators

```

NORMAL FLOAT AUTO REAL RADIAN MP
Send("CONNECT
1:LED
2:RGB
3:SPEAKER
4:POWER
5:SERVO,CONTINUOUS
6:ANALOG.OUT
7:VIB.MOTOR
8:BUZZER
9:RELAY

```

```

NORMAL FLOAT AUTO REAL RADIAN MP
Send("CONNECT
6:ANALOG.OUT
7:VIB.MOTOR
8:BUZZER
9:RELAY
0:SERVO
R:SQUAREWAVE
B:DIGITAL.OUT
C:BBPORT
D:Send("CONNECT

```

TI-Nspire™ CX

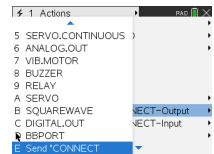
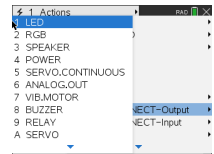

LED i [TO] OUT n/BB n

Command:	LED i [TO] OUT n/BB n
Command Syntax:	CONNECT LED i [TO] OUT n/BB n

Command:	LED i [TO] OUT n/BB n
Range:	
Describe:	<p>This object provides the ability to connect external LED objects. The LED object is either connected to a PWM function (if available, and the pin connecting to supports it), or a digital output pin which will be driven at 50% duty cycle; or the specified blink rate if one is specified in the SET operation.</p> <p>CONNECT LED 1i [TO] BB3 CONNECT LED 2i [TO] OUT1</p>
Result:	LED connected to specific port.
Type or Addressable Component:	Control

RGB i / COLOR [TO] BB r BB g BB b

Command:	RGB i / COLOR [TO] BB r BB g BB b
Command Syntax:	CONNECT RGB i / COLOR [TO] BB r BB g BB b
Range:	
Describe:	<p>Connects an external RGB LED to three PWM-capable pins. If insufficient PWM pins are available for mapping to PWM function, an error will be given. To connect an external RGB, the on-board RGB LED should be DISCONNECTED before the attempt to connect the external RGB is performed.</p> <p>CONNECT RGB 1 [TO] BB8 BB9 BB10</p>
Result:	Digital pins supporting PWM.
Type or Addressable Component:	Control

SPEAKER i [TO] OUT n/BB n

Command:	SPEAKER i [TO] OUT n/BB n
Command Syntax:	CONNECT SPEAKER i [TO] OUT n/BB n

Command:	SPEAKER i [TO] OUT n/BB n
Range:	
Describe:	Connect an external speaker for sound generation. Requires a digital output pin. CONNECT SPEAKER 1 [TO] OUT 1 CONNECT SPEAKER i [TO] BB 3
Result:	Connect a speaker to a digital output port or pin.
Type or Addressable Component:	Control

POWER

Command:	CONNECT POWER n [TO] OUT1/OUT2/OUT3
Command Syntax:	CONNECT POWER n [TO] OUT1/OUT2/OUT3
Range	
Describe:	Connects a POWER object to the specified analog output port. Default PWM value is zero.
Result:	The named POWER device can be used in the program after a CONNECT command.
Type or Addressable Component:	Control

SERVO.CONTINUOUS i [TO] BB 6

Command:	SERVO.CONTINUOUS i [TO] BB 6
Command Syntax:	CONNECT SERVO.CONTINUOUS i [TO] BB 6
Code Sample:	
Range:	

Command:	SERVO.CONTINUOUS i [TO] BB 6
Describe:	Used to connect either a normal sweep servo motor, or a continuous servo motor. External power must be provided before attempting to connect the servo. CONNECT SERVO.CONTINUOUS i [TO] BB 6
Result:	Servo motor with -90 to 90 degree movement.
Type or Addressable Component:	Control

ANALOG.OUT i [TO] OUT i/BB i

Command:	ANALOG.OUT i [TO] OUT n/BB n
Command Syntax:	CONNECT ANALOG.OUT i [TO] OUT n/BB n
Range:	
Describe:	Connect a generic “analog” output control to a pin/port that supports analog input. ANALOG.OUT shares number space with DCMOTOR and SQUAREWAVE objects. CONNECT ANALOG.OUT i [TO] OUT 1 CONNECT ANALOG.OUT i [TO] BB 4 CONNECT ANALOG.OUT i [TO] BB 1
Result:	Connect analog output to pin. If pin supports hardware pulse with modulation (PWM), the object uses. If the pin does not support hardware-generated PWM , the sketch will generate PWM in software at 490 Hz with the duty cycle specific between 0 (none) and 255 (full on).
Type or Addressable Component:	Control

VIB.MOTOR

Command:	VIB.MOTOR i [TO] PWM
Command Syntax:	SET VIB.MOTOR i [TO] PWM

Command:	VIB.MOTOR i [TO] PWM
Range:	PWM from 0 (none) and 255 (full on)
Describe:	Vibration motor control interface.
Result:	Vibrations : intensity is a value from 0 to 255.
Type or Addressable Component:	Control

BUZZER i [TO] OUT n/BB n

Command:	BUZZER i [TO] OUT n/BB n
Command Syntax:	CONNECT BUZZER i [TO] OUT n/BB n
Range:	
Describe:	Connect an external active buzzer to an output digital pin. Active buzzers play a tone when their signal is set high/on, and stop the tone when the signal is dropped to ground. For piezo or passive buzzers, use the SPEAKER object type to allow generation of multiple tones. CONNECT BUZZER i [TO] OUT1
Result:	ACTIVE buzzers connect to a digital pin.
Type or Addressable Component:	Control

RELAY i [TO] OUT n/BB n

Command:	RELAY i [TO] OUT n/BB n
Command Syntax:	CONNECT RELAY i [TO] OUT n/BB n
Range:	
Describe:	With external power required, connect a relay module to a given control signal pin. Since the control is digital, as long as external power is present, any pin may be used.

Command:	RELAY i [TO] OUT n/BB n
	CONNECT RELAY 1 [TO] BB 3 CONNECT RELAY 1 [TO] OUT 2
Result:	Relays.
Type or Addressable Component:	Control

SERVO i [TO] OUT 3

Command:	SERVO i [TO] OUT 3
Command Syntax:	CONNECT SERVO i [TO] OUT 3
Code Sample:	
Range:	
Describe:	Used to connect either a normal sweep servo motor, or a continuous servo motor. External power must be provided before attempting to connect the servo. Note: Servo motors should only be connected to OUT 3. CONNECT SERVO 1 [TO] OUT 3
Result:	Servo motor is connected to port.
Type or Addressable Component:	Control

SQUAREWAVE i [TO] OUT n/BB n

Command:	SQUAREWAVE i [TO] OUT n/BB n
Command Syntax:	CONNECT SQUAREWAVE i [TO] OUT n/BB n
Range:	
Describe:	Connect a software generated digital waveform generator object.

Command:	SQUAREWAVE i [TO] OUT n/BB n
	These objects share the number-space with the DCMOTOR and ANALOG.OUT output objects. The associated pin is configured as a digital output signal. CONNECT SQUAREWAVE n [TO] BB 2
Result:	Digital output squarewave from 1 to 500 hz.
Type or Addressable Component:	Control

DIGITAL.OUT i [TO] OUT n/BB n [[AS] OUTPUT]

Command:	DIGITAL.OUT i [TO] OUT n/BB n [[AS] OUTPUT]
Command Syntax:	CONNECT DIGITAL.OUT i [TO] OUT n/BB n
Range:	
Describe:	Connects a generic digital object to a specified pin or port. The connected pin is configured either as a digital output signal, default LOW, or a digital input signal, default INPUT with no pullup or pulldown enabled. The index number can refer to either an input or output. The index is shared by both items since a DIGITAL signal can be either an input or output. CONNECT DIGITAL.OUT 1 [TO] OUT n/BB n
Result:	Connect pin to digital object default output state, default OUTPUT , low.
Type or Addressable Component:	Control/Sensor

BBPORT

Command:	CONNECT BBPORT
Command Syntax:	CONNECT BBPORT [MASK value]
Range:	
Describe:	<p>When the optional MASK is not specified, this command connects all 10 BB pins to the BBPORT object as digital I/O pins.</p> <p>The optional MASK parameter may be used to selectively connect specific pins. The mask value may be specified in decimal, binary, or hexadecimal format. For example, 1023 or 0X3FF selects all 10 pins and is the default internal mask value used by the BBPORT object if a MASK is not specified.</p> <p>Another example: If only pins BB1 and BB2 are going to be used, a mask value of 3 or 0x03 will select on the two pins.</p>
Result:	<p>If not MASK is specified, the program can read/write to all pins of BBPORT.</p> <p>If a MASK is specified, the program can write to the specified pins.</p>
Type or Addressable Component:	Sensor

DCMOTOR i [TO] OUT n/BB n

Command:	DCMOTOR i [TO] OUT n/BB n
Command Syntax:	CONNECT DCMOTOR i [TO] OUT n/BB n
Range:	
Describe:	<p>Connect an external DC Motor object. This object requires the presence of power on the external power connector to allow operation. These objects share the number-space with the SQUAREWAVE output objects and ANALOG.OUT objects. The associated pin is configured as a digital output signal.</p> <p>CONNECT DCMOTOR i [TO] OUT1</p>
Result:	Connect DCMOTOR to a digital output pin.
Type or Addressable Component:	Control

LIGHT

Command:	LIGHT
Command Syntax:	CONNECT LIGHT
Range:	
Describe:	<p>This command is not needed for typical use since the on-board LIGHT (i.e. RED LED) is automatically connected.</p> <p>Re-connect a previously disconnected on-board RED LED. The LIGHT is always connected when the system is reset, or powered-on, or the BEGIN command is used to restore system state. No pin number is required.</p> CONNECT LIGHT
Result:	Connects on-board digital LED (red) to known fixed pin. Digital only.
Type or Addressable Component:	Control

COLOR

Command:	COLOR
Command Syntax:	CONNECT COLOR
Range:	
Describe:	<p>This command is not needed for typical use since the on-board COLOR LED is automatically connected.</p> <p>(Re-)connect the internal RGB LED. No pins are required for this command to operate as the internal pins are known. This sensor is automatically connected when the TI-Innovator is initially powered, and when the BEGIN command is used. When disconnected, two PWM signals are freed for external use by other pins.</p> CONNECT COLOR
Result:	Connects on-board RGB LED to fixed pins on board. Uses 3 PWMs .
Type or Addressable Component:	Control

SOUND

Command:	SOUND
Command Syntax:	CONNECT SOUND
Range:	
Describe:	<p>This command is not needed for typical use since the on-board object SOUND is automatically connected.</p> <p>Re-connect the on-board speaker for sound generation. No pin needed as it uses known, fixed pin for signal.</p> CONNECT SOUND
Result:	Connects on-board speaker to fixed output digital pin.
Type or Addressable Component:	Control

CONNECT-Input

CONNECT associates a given control or sensor with a pin or port on the TI-Innovator. If the specified control or sensor is currently in use, an error will be generated. If the pin or port specified in the **CONNECT** command is currently in use, an error will be generated.

The **CONNECT** command does not generate an active response, but a variety of errors may occur during a connection attempt, such as pin-in-use, unsupported, invalid options, bad options, etc.

CONNECT 'something i' [TO] IN1/IN2/IN3/OUT1/OUT2/OUT3/BB1

Command:	CONNECT
Command Syntax:	CONNECT
Range:	
Describe:	Associates a sensor or control with a given port or pin(s). Places the respective pin(s) in use
Result:	
Type or Addressable Component:	

CE Calculators

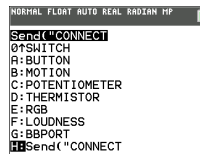
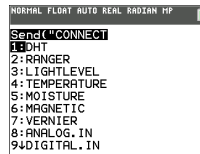

TI-Nspire™ CX

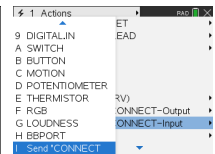
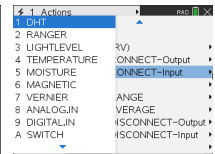

DHT i [TO] IN n

Command:	DHT i [TO] IN n
Command Syntax:	CONNECT DHT i [TO] IN n

Command:	DHT i [TO] IN n
Range:	Temperature reading default is in Celsius Humidity reading from 0 to 100 %
Describe:	The DHT digital temperature humidity sensor can be connected via this object. The DHT can be either a DHT11 or DHT22 and is identified automatically when connected to the system via a digital signal line. CONNECT DHT i [TO] IN1
Result:	Digital humidity/temperature sensors (DHT11/DHT22, type is auto-detected).
Type or Addressable Component:	Sensor

RANGER i [TO] IN n

Command:	RANGER i [TO] IN n
Command Syntax:	CONNECT RANGER i [TO] IN n
Range:	
Describe:	Connect an external ultrasonic distance ranging module to an input port. CONNECT RANGER 1i [TO] IN 1
Result:	Ultrasonic ranging sensors with either individual trigger/echo pins, or same pin used for trigger/echo.
Type or Addressable Component:	Sensor

LIGHTLEVEL i [TO] IN n/BB n

Command:	LIGHTLEVEL i [TO] IN n/BB n
Command Syntax:	CONNECT LIGHTLEVEL i [TO] IN n/BB n
Range:	An integer value between 0 and 16383 (14 bit resolution)
Describe:	Connects an external light sensor. External light sensors can be

Command:	LIGHTLEVEL i [TO] IN n/BB n
	analog sensors. CONNECT LIGHTLEVEL 1i [TO] IN1
Result:	Analog light level sensors is connected to the specific port.
Type or Addressable Component:	Sensor

TEMPERATURE i [TO] IN n/BB n

Command:	TEMPERATURE i [TO] IN n/BB n				
Command Syntax:	CONNECT TEMPERATURE i [TO] IN n/BB n				
Range:	Temperature reading default is in Celsius. The range depends on the specific temperature sensor being used. Humidity reading from 0 to 100 %				
Describe:	<p>Connects a temperature sensor to the system using either of several connection methods.</p> <p>Note: The default temperature sensor is included in the Breadboard pack</p> <p>If the sensor is based on a thermistor and provides an analog output, it uses a single analog input pin. If the sensor is a DS18B20 digital temperature sensor, it uses a single bi-directional digital GPIO pin.</p> <p>The analog thermistor temperature sensors is by default, assumed to be a PTC thermistor. If the thermistor is an NTC style, an optional keyword can be added to the connect command sequence to change the style of the thermistor.</p> <p>The analog thermistor temperature sensor uses a specific set of thermistor constants, different than those used by the THERMISTOR object, to convert the reading into a temperature reading. The constants are used in the Steinhart-Hart model to convert the analog reading to temperature.</p> <table border="1" data-bbox="236 1182 788 1282"> <thead> <tr> <th>Description</th> <th>Value</th> </tr> </thead> <tbody> <tr> <td>C1</td> <td>8.76741e-8</td> </tr> </tbody> </table>	Description	Value	C1	8.76741e-8
Description	Value				
C1	8.76741e-8				

Command:	TEMPERATURE i [TO] IN n/BB n									
	<table border="1"> <thead> <tr> <th>Description</th> <th>Value</th> </tr> </thead> <tbody> <tr> <td>C2</td> <td>2.34125e-4</td> </tr> <tr> <td>C3</td> <td>1.129148e-3</td> </tr> <tr> <td>R1 – reference resistance</td> <td>10000.0 ohms</td> </tr> </tbody> </table>	Description	Value	C2	2.34125e-4	C3	1.129148e-3	R1 – reference resistance	10000.0 ohms	
Description	Value									
C2	2.34125e-4									
C3	1.129148e-3									
R1 – reference resistance	10000.0 ohms									
	<p>CONNECT TEMPERATURE i [TO] IN 1 – thermistor sensor attached to analog input.</p> <p>CONNECT TEMPERATURE i [TO] BB 1 – DS18B20 digital attached to digital pin.</p> <p>CONNECT TEMPERATURE i [TO] I2 C – LM75A attached to I2C port.</p> <p>CONNECT TEMPERATURE i [TO] BB 5 NTC – connect an analog temperature sensor to analog input and specifies an NTC style thermistor.</p> <p>CONNECT TEMPERATURE i [TO] BB 6 PTC – connect an analog temperature sensor to analog input and specifies a PTC style thermistor.</p>									
Result:	Analog temperature sensor.									
Type or Addressable Component:	Sensor									

MOISTURE i [TO] IN n/BB n

Command:	MOISTURE i [TO] IN n/BB n	
Command Syntax:	CONNECT MOISTURE i [TO] IN n/BB n	
Range:	An integer value between 0 and 16383 (14 bit resolution)	
Describe:	<p>Connect an analog moisture sensor to return relative moisture readings.</p> <p>CONNECT MOISTURE 1i [TO] IN 1</p>	
Result:	Analog moisture sensors.	
Type or Addressable Component:	Sensor	

MAGNETIC

Command:	MAGNETIC i [TO] IN n
Command Syntax:	CONNECT MAGNETIC 1 TO IN 1
Range	
Describe:	The MAGNETIC sensor is used to detect the presence of a magnetic field. It uses the Hall effect. It is also known as a Hall effect sensor.
Result:	The MAGNETIC sensor is now available to use.
Type or Addressable Component:	Sensor

VERNIER

Command:	CONNECT VERNIER i TO IN n
Command Syntax:	CONNECT VERNIER 1 TO IN 1 AS LIGHT CONNECT VERNIER 2 TO IN 2 AS ACCEL CONNECT VERNIER 1 TO IN 1 AS ENERGY
Range	
Describe:	This command is used when a Vernier analog sensor is connected to the TI-Innovator™ Hub through the TI-SensorLink There is support for three additional Vernier analog sensors <ul style="list-style-type: none">• LS-BTA• LGA-BTA• VES-BTA
Result:	
Type or Addressable Component:	Sensor

ANALOG.IN i [TO] IN n/BB n

Command:	ANALOG.IN i [TO] IN n/BB n
Command Syntax:	CONNECT ANALOG.IN i [TO] IN n/BB n
Range:	
Describe:	Connect a generic “analog” input sensor to a pin/port that supports analog input. CONNECT ANALOG.IN i [TO] IN 1 CONNECT ANALOG.IN i [TO] BB 5
Result:	Connect analog input to pin that supports that function (error if pin is not analog-input capable).
Type or Addressable Component:	Sensor

DIGITAL.IN i [TO] IN n/BB n [[AS] INPUT|PULLUP|PULLDOWN]

Command:	DIGITAL.IN i [TO] IN n/BB n [[AS] INPUT PULLUP PULLDOWN]
Command Syntax:	CONNECT DIGITAL.IN i [TO] IN n/OUT n/BB n
Range:	
Describe:	Connects a generic digital object to a specified pin or port. The connected pin is configured either as a digital output signal, default LOW, or a digital input signal, default INPUT with no pullup or pulldown enabled. The index number can refer to either an input or output. The index is shared by both items since a DIGITAL signal can be either an input or output. CONNECT DIGITAL.IN 1 [TO] IN 1
Result:	Connect pin to digital object default input state, default INPUT .
Type or Addressable Component:	Control/Sensor

SWITCH i [TO] IN n/BB n

Command:	SWITCH i [TO] IN n/BB n
Command Syntax:	CONNECT SWITCH i [TO] IN n/BB n
Range:	
Describe:	<p>Connect an external switch to a digital input pin. The button task will monitor the state of the switch allowing reporting for the switch on, not on, and was on since last checked. The connected pin is set to a digital input state with its internal pulldown enabled. The other side of the switch is connected to a power supply (3.3v) pin (or 5v supply if using IN3 port). Switches share number space with Buttons.</p> <p>CONNECT SWITCH 1 [TO] IN 1 CONNECT SWITCH 2 [TO] BB 5</p>
Result:	Connect a switch object (similar to button, but connected to Vcc instead of Gnd when enabled.)
Type or Addressable Component:	Sensor

BUTTON i [TO] IN n/BB n

Command:	BUTTON i [TO] IN n/BB n
Command Syntax:	CONNECT BUTTON i [TO] IN n/BB n
Range:	
Describe:	<p>Connect an external button to a digital input pin. The button task will monitor the state of the button allowing reporting for the button pressed, not pressed, and was pressed since last checked. The connected pin is set to a digital input state with its internal pullup enabled. The other side of the button is connected to a ground pin. Buttons share number space with Switches.</p> <p>CONNECT BUTTON i [TO] IN 1</p>
Result:	Digital button/switch/etc.
Type or Addressable Component:	Sensor

MOTION i [TO] IN n/BB n

Command:	MOTION i [TO] IN n/BB n
Command Syntax:	CONNECT MOTION i [TO] IN n/BB n
Range:	
Describe:	Connects a digital PIR (passive infrared) motion detection sensor to a digital input pin. This sensor is monitored the same as button objects for a three-state result. CONNECT MOTION 1i [TO] IN 1
Result:	Passive I/R motion detectors.
Type or Addressable Component:	Sensor

POTENTIOMETER i [TO] IN n/BB n

Command:	POTENTIOMETER i [TO] IN n/BB n
Command Syntax:	CONNECT POTENTIOMETER i [TO] IN n/BB n
Range:	
Describe:	Connect an external slide or rotary potentiometer to an analog input pin. CONNECT POTENTIOMETER 1i [TO] IN 2 CONNECT POTENTIOMETER 1 [TO] BB 2
Result:	Rotary- potentiometer sensors.
Type or Addressable Component:	Sensor

THERMISTOR i [TO] IN n/BB n

Command:	THERMISTOR i [TO] IN n/BB n										
Command Syntax:	CONNECT THERMISTOR i [TO] IN n/BB n										
Range:											
Describe:	<p>Connects a PTC thermistor to the system using a single analog input pin. The thermistor sensor uses the following values in the Steinhart-Hart model to convert the reading into a temperature.</p> <table border="1"><thead><tr><th>Description</th><th>Value</th></tr></thead><tbody><tr><td>C1</td><td>1.33342e-7</td></tr><tr><td>C2</td><td>2.22468e-4</td></tr><tr><td>C3</td><td>1.02119e-3</td></tr><tr><td>R1 – reference resistance</td><td>15000.0 ohms</td></tr></tbody></table> <p>CONNECT THERMISTOR i [TO] IN 1 CONNECT THERMISTOR i [TO] BB 5</p>	Description	Value	C1	1.33342e-7	C2	2.22468e-4	C3	1.02119e-3	R1 – reference resistance	15000.0 ohms
Description	Value										
C1	1.33342e-7										
C2	2.22468e-4										
C3	1.02119e-3										
R1 – reference resistance	15000.0 ohms										
Result:	Analog thermistor.										
Type or Addressable Component:	Sensor										

RGB

Command:	CONNECT RGB
Command Syntax:	CONNECT RGB
Range	n/a
Describe:	<p>This command configures the sketch to use the TI-RGB Array. The array needs to be pre-connected through the BB port. An incorrect connection will result in an error indication.</p>
Result:	The RGB array is now available for use in the program.
Type or Addressable Component:	Sensor TI-RGB Array Data Sheet

LOUDNESS i [TO] IN n

Command:	LOUDNESS i [TO] IN n
Command Syntax:	CONNECT LOUDNESS i [TO] IN n
Range:	
Describe:	The LOUDNESS object measure sound intensity (loudness). CONNECT LOUDNESS i1 [TO] IN2
Result:	Analog sound level sensors.
Type or Addressable Component:	Sensor

BBPORT

Command:	CONNECT BBPORT
Command Syntax:	CONNECT BBPORT [MASK value]
Range:	
Describe:	<p>When the optional MASK is not specified, this command connects all 10 BB pins to the BBPORT object as digital I/O pins.</p> <p>The optional MASK parameter may be used to selectively connect specific pins. The mask value may be specified in decimal, binary, or hexadecimal format. For example, 1023 or 0X3FF selects all 10 pins and is the default internal mask value used by the BBPORT object if a MASK is not specified.</p> <p>Another example: If only pins BB1 and BB2 are going to be used, a mask value of 3 or 0x03 will select on the two pins.</p>
Result:	<p>If not MASK is specified, the program can read/write to all pins of BBPORT.</p> <p>If a MASK is specified, the program can write to the specified pins.</p>
Type or Addressable Component:	Sensor

BRIGHTNESS

Command:	BRIGHTNESS
Command Syntax:	CONNECT BRIGHTNESS
Range:	
Describe:	<p>This command is not needed for typical use since the on-board BRIGHTNESS sensor is automatically connected.</p> <p>(Re-)connect the internal analog ambient light sensor. No pin or port name is used with this internal object.</p>
Result:	Connects on-board light sensor to known analog input pin.
Type or Addressable Component:	Sensor

Ports

Settings menu contains operations to set the state of digital and analog pin operations such as the LED in the TI-Innovator™ Hub or a connected servo motor movement to states such as ON, OFF, CW (clockwise), and CCW (counterclockwise).

- 1: OUT 1
- 2: OUT 2
- 3: OUT 3
- 4: IN 1
- 5: IN 2
- 6: IN 3
- 7: I2C
- 8: BB 1
- 9: BB 2
- 0: BB 3
- A: BB 4
- B: BB 5
- C: BB 6
- D: BB 7
- E: BB 8
- F: BB 9
- G: BB 10
- H: BBPORT

CE Calculators

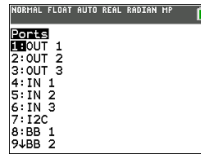

TI-Nspire™ CX

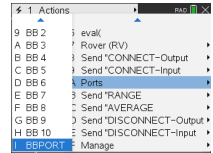
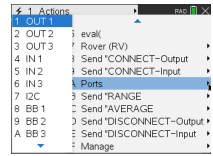

See also: Breadboard Components and Usable Pins

RANGE

The **RANGE** command is used with several analog input sensors to re-map the internal ADC (Analog to Digital Converter) range of 0 to 16383 (14-bit ADC values) to a floating point range specified as the parameters to this command, along with the sensor to which the range is applied. The format for setting the range of a sensor is **RANGE sensor [i] minimum maximum**. To remove/reset to default the range from a given sensor, set the minimum and maximum value to zero. The minimum value must be less than the maximum value when setting a valid range.

A sensors current range, if present, can be obtained by **READ sensor [i] RANGE**. A two-element list of numbers in the form { *minimum, maximum* } will be returned.

Note: If no range has been applied to the sensor, an error will be returned if an attempt to read the sensor range is performed .

An individual sensors averaging value may be obtained by **READ sensor [i] RANGE**.

RANGE 'something' (for analog devices, maps ADC range from 0 to 16383 to the range specified, min < max, min, max any values.)

CE Calculators

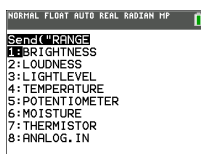

TI-Nspire™ CX

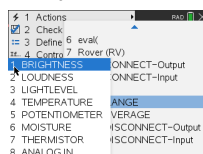

BRIGHTNESS minimum maximum

Command:	BRIGHTNESS minimum maximum
	Advanced user
Command Syntax:	RANGE BRIGHTNESS minimum maximum
Range:	
Describe:	Changes/Sets the mapping of ADC input values from the ADC 0-16383 range to a user-selected range. The resulting sensor reading is mapped to this and a floating point result is returned. By default, the on-board BRIGHTNESS sensor is ranged to a 0-100 range. RANGE BRIGHTNESS minimum maximum
Result:	Set mapping for on-board brightness/light sensor.
Type or	Sensor

Command:	BRIGHTNESS minimum maximum
	Advanced user
Addressable Component:	

LOUDNESS i minimum maximum

Command:	LOUDNESS i minimum maximum
	Advanced user
Command Syntax:	RANGE LOUDNESS i minimum maximum
Range:	
Describe:	Changes/Sets the mapping of ADC input values from the ADC 0-16383 range to a user-selected range. The resulting sensor reading is mapped to this and a floating point result is returned. RANGE LOUDNESS i minimum maximum
Result:	Set mapping for sound-level analog sensor.
Type or Addressable Component:	Sensor

LIGHTLEVEL i minimum maximum

Command:	LIGHTLEVEL i minimum maximum
	Advanced user
Command Syntax:	RANGE LIGHTLEVEL i minimum maximum
Range:	An integer value between 0 and 16383 (14 bit resolution)
Describe:	Changes/Sets the mapping of ADC input values from the ADC 0-16383 range to a user-selected range. The resulting sensor reading is mapped to this and a floating point result is returned. RANGE LIGHTLEVEL i minimum maximum

Command:	LIGHTLEVEL i minimum maximum Advanced user
Result:	Set mapping for off-board light sensor (analog).
Type or Addressable Component:	Sensor

TEMPERATURE i minimum maximum

Command:	TEMPERATURE i minimum maximum Advanced user
Command Syntax:	RANGE TEMPERATURE i minimum maximum
Range:	
Describe:	. RANGE TEMPERATURE i minimum maximum
Result:	Set mapping for soil moisture analog sensor.
Type or Addressable Component:	Sensor

POTENTIOMETER i minimum maximum

Command:	POTENTIOMETER i minimum maximum Advanced user
Command Syntax:	RANGE POTENTIOMETER i minimum maximum
Range:	
Describe:	Changes/Sets the mapping of ADC input values from the ADC 0-16383 range to a user-selected range. The resulting sensor reading is mapped to this and a floating point result is returned. RANGE

Command:	POTENTIOMETER i minimum maximum Advanced user
	POTENTIOMETER i minimum maximum
Result:	Set mapping for rotary/linear potentiometers.
Type or Addressable Component:	Sensor

MOISTURE i minimum maximum

Command:	MOISTURE i minimum maximum Advanced user
Command Syntax:	RANGE MOISTURE i minimum maximum
Range:	An integer value between 0 and 16383 (14 bit resolution)
Describe:	Changes/Sets the mapping of ADC input values from the ADC 0-16383 range to a user-selected range. The resulting sensor reading is mapped to this and a floating point result is returned. RANGE MOISTURE i minimum maximum
Result:	Set mapping for soil moisture analog sensor.
Type or Addressable Component:	Sensor

THERMISTOR i minimum maximum

Command:	THERMISTOR i minimum maximum Advanced user
Command Syntax:	RANGE THERMISTOR i minimum maximum
Range:	

Command:	THERMISTOR i minimum maximum Advanced user
Describe:	. RANGE THERMISTOR i minimum maximum
Result:	Set mapping for xxxxxxxxxx.
Type or Addressable Component:	Sensor

ANALOG.IN i minimum maximum

Command:	ANALOG.IN i minimum maximum Advanced user
Command Syntax:	RANGE ANALOG.IN i minimum maximum
Range:	
Describe:	Changes/Sets the mapping of ADC input values from the ADC 0-16383 range to a user-selected range. The resulting sensor reading is mapped to this and a floating point result is returned. RANGE ANALOG.IN i minimum maximum
Result:	Set mapping for generic analog input objects.
Type or Addressable Component:	Sensor

AVERAGE

The **AVERAGE** command is used to set the number of ADC (Analog to Digital converter) samples taken to represent a single analog sensor reading. By default, the TI-Innovator™ Hub sets a global value of three (3) readings to be taken for a sensor measurement. This is done to reduce variation due to noise etc. This default is adjustable between 1 and 25 by the **SET AVERAGING n** command. The current default can be obtained by the **READ AVERAGING** command.

For individual sensors, the default can be changed after the **CONNECT** operation by using the **AVERAGE sensor [i] value** where sensor is a sensor from the table below, [i] is the index, if needed to identify the specific sensor, and value is a number from 1 to 25.

The sensor, when a sample is requested, will take value number of readings, 10 microseconds apart, summing the readings together and averaging them over the number of readings taken.

An individual sensors averaging value may be obtained by **READ sensor [i] AVERAGE**.

AVERAGE 'something' (for analog devices, sets the individual oversampling value for reading, from 1 to 25)

Command:	AVERAGE
Command Syntax:	AVERAGE
Describe:	Specifies the number of analog readings to take on a specific sensor to obtain a single reading of that sensor. Valid values are from 1 to 25 readings, taken 10 microseconds apart and averaged together. Sensors use the system default of 3 readings if not altered by changing the system global setting via a SET AVERAGING command.
Result:	
Type or Addressable Component:	

CE Calculators

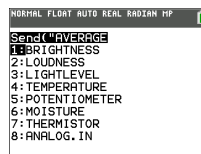

TI-Nspire™ CX

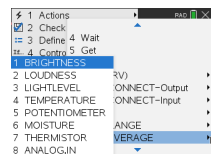

BRIGHTNESS n

Command:	BRIGHTNESS n
Command Syntax:	AVERAGE BRIGHTNESS n
Range:	Where n ranges from 1 to 25
Describe:	Set the number of readings from the ADC to be used for the on-board light sensor.
Result:	Set oversampling for on-board brightness/light sensor.
Type or Addressable Component:	Sensor

LOUDNESS i n

Command:	LOUDNESS i n
Command Syntax:	AVERAGE LOUDNESS i n
Range:	– where n ranges from 1 to 25
Describe:	Set the number of readings from the ADC to be used with an external sound loudness sensor.
Result:	Set oversampling for sound-level analog sensor.
Type or Addressable Component:	Sensor

LIGHTLEVEL i n

Command:	LIGHTLEVEL i n
Command Syntax:	AVERAGE LIGHTLEVEL i n
Range:	– where n ranges from 1 to 25
Describe:	Set the number of readings from the ADC to be used for the

Command:	LIGHTLEVEL i n
	external light sensor connected to an analog input. Does not support I ² C light sensors.
Result:	Set oversampling for off-board light sensor (analog).
Type or Addressable Component:	Sensor

TEMPERATURE i n

Command:	TEMPERATURE i n
Command Syntax:	AVERAGE TEMPERATURE i n
Range:	Where n ranges from 1 to 25
Describe:	Set the number of readings from the ADC to be used for the external temperature sensor connected to an analog input. Does not support I ² C or digital temperature sensors.
Result:	When using an analog-style thermistor temperature sensor, oversample this many times.
Type or Addressable Component:	Sensor

POTENTIOMETER i n

Command:	POTENTIOMETER i n
Command Syntax:	AVERAGE POTENTIOMETER i n
Range:	Where n ranges from 1 to 25
Describe:	Set the number of readings from the ADC to be used with an external potentiometer, either a linear or rotary model.
Result:	Set oversampling for rotary/linear potentiometers.
Type or Addressable	Sensor

Command:	POTENTIOMETER i n
Component:	

MOISTURE i n

Command:	MOISTURE i n
Command Syntax:	AVERAGE MOISTURE i n
Range:	– where n ranges from 1 to 25
Describe:	Set the number of readings from the ADC to be used with an external moisture sensor.
Result:	Set oversampling for soil moisture analog sensor.
Type or Addressable Component:	Sensor

THERMISTOR i n

Command:	THERMISTOR i n
Command Syntax:	AVERAGE THERMISTOR i n
Range:	Where n ranges from 1 to 25
Describe:	Set the number of readings from the ADC to be used with an external thermistor connected to an analog input.
Result:	Set oversampling for thermistor device analog input.
Type or Addressable Component:	Sensor

ANALOG.IN i n

Command:	ANALOG.IN i n
Command Syntax:	AVERAGE ANALOG.IN i n
Range:	Where n ranges from 1 to 25
Describe:	Set the number of readings from the ADC to be used for the analog sensor attached to this generic analog item.
Result:	Sets oversampling count for generic analog input.
Type or Addressable Component:	Sensor

PERIOD n

Command:	PERIOD n
Command Syntax:	PERIOD n
Range:	
Describe:	The AVERAGE command is somewhat unique for PERIOD in that it specifies how many distinct periods are to be measured and averaged together to obtain the desired measurement. Up to 25 samples may be taken to obtain the period measurement for a given pin.
Result:	Set number of samples of frequency to take to be average together to generate period.
Type or Addressable Component:	Sensor

DISCONNECT-Output

DISCONNECT breaks the association between a specified control or sensor and the pin/port it is associated with. If the specified sensor or control is not currently connected to anything, an error is generated.

The **DISCONNECT** command does not generate an active response, other than possible error responses. Pins associated with an actively connected sensor, or control, are released from use and, in general, are set to a digital input state with no enabled pullup/pulldown.

DISCONNECT - disconnect something that has been connected, by index if needed.

Command:	DISCONNECT-Output
Command Syntax:	DISCONNECT
Range:	
Describe:	Removes the association of a sensor or control with a pin, or set of pins, if such association exists. Places the pin(s) back to an OUTPUT state.
Result:	.
Type or Addressable Component:	

CE Calculators

```
NORMAL FLOAT AUTO REAL RADIAN HP
Send("DISCONNECT
1: LED
2: RGB
3: SPEAKER
4: POWER
5: SERVO, CONTINUOUS
6: ANALOG, OUT
7: VIB, MOTOR
8: BUZZER
9: RELAY
```

```
NORMAL FLOAT AUTO REAL RADIAN HP
Send("DISCONNECT
6: ANALOG, OUT
7: VIB, MOTOR
8: BUZZER
9: RELAY
0: SERVO
R: SQUAREWAVE
B: DIGITAL, OUT
C: BBPORT
D: Send("DISCONNECT
```

TI-Nspire™ CX

```
1 Actions
1 LED
2 RGB
3 SPEAKER
4 POWER
5 SERVO, CONTINUOUS
6 ANALOG, OUT
7 VIB, MOTOR
8 BUZZER
9 RELAY
A SERVO
CONNECT-Output
CONNECT-Input
```

```
1 Actions
5 SERVO, CONTINUOUS
6 ANALOG, OUT
7 VIB, MOTOR
8 BUZZER
9 RELAY
A SERVO
B SQUAREWAVE
C DIGITAL, OUT
D BBPORT
Send("DISCONNECT
CONNECT-Output
CONNECT-Input
```

LED i

Command:	LED i
Command Syntax:	DISCONNECT LED i
Range:	
Describe:	Disconnect an external LED object from the system.
Result:	LED i is disconnected
Type or Addressable Component:	Control

RGB i

Command:	RGB i
Command Syntax:	DISCONNECT RGB i
Range:	
Describe:	Disconnect an external RGB LED from the system. These objects use three hardware PWM signals to properly operate, so in the initial product release, the on-board COLOR object must be disconnected to connect one of these objects.
Result:	Disconnect RGB and free up PWM outputs for use elsewhere.
Type or Addressable Component:	Control

SPEAKER i

Command:	SPEAKER i
Command Syntax:	DISCONNECT SPEAKER i

Command:	SPEAKER i
Range:	
Describe:	Disconnect an external speaker from its digital pin.
Result:	Disconnect a speaker from a digital output pin.
Type or Addressable Component:	Control

POWER

Command:	DISCONNECT POWER i
Command Syntax:	DISCONNECT POWER 1
Range	
Describe:	This command removes the name POWER device from the program.
Result:	The named POWER device cannot be used in the program after a DISCONNECT command.
Type or Addressable Component:	Control

SERVO.CONTINUOUS i

Command:	SERVO CONTINUOUS i
Command Syntax:	DISCONNECT SERVO.CONTINUOUS i
Code Sample:	
Range:	
Describe:	Disconnect a sweep or continuous SERVO motor from the digital pin associated with the motor.

Command:	SERVO CONTINUOUS i
Result:	Servo motor disconnected.
Type or Addressable Component:	Control

ANALOG.OUT i

Command:	ANALOG.OUT i
Command Syntax:	DISCONNECT ANALOG.OUT i
Range:	
Describe:	Disconnects the connected generic analog output device specified, freeing a hardware map-able PWM if it is in use with the object.
Result:	Disconnect generic analog PWM output from pin.
Type or Addressable Component:	Control

VIB.MOTOR

Command:	VIB.MOTOR i [TO] PWM
Command Syntax:	SET VIB.MOTOR i [TO] PWM
Range:	PWM from 0 (none) and 255 (full on)
Describe:	Vibration motor control interface.
Result:	Vibrations : intensity is a value from 0 to 255.
Type or Addressable Component:	Control

BUZZER i

Command:	BUZZER i
Command Syntax:	DISCONNECT BUZZER i
Range:	
Describe:	Disconnect an active buzzer from the system. Active buzzers play a tone when their signal is set high/on, and stop the tone when the signal is dropped to ground. DISCONNECT BUZZER i
Result:	ACTIVE buzzers disconnected from a digital pin.
Type or Addressable Component:	Control

RELAY i

Command:	RELAY i
Command Syntax:	DISCONNECT RELAY i

Command:	RELAY i
Range:	
Describe:	Disconnect a digital relay interface from the system.
Result:	Relay disconnected.
Type or Addressable Component:	Control

SERVO i

Command:	SERVO i
Command Syntax:	DISCONNECT SERVO i
Code Sample:	
Range:	
Describe:	Disconnect a sweep or continuous SERVO motor from the digital pin associated with the motor.
Result:	Servo motor disconnected.
Type or Addressable Component:	Control

SQUAREWAVE i

Command:	SQUAREWAVE i
Command Syntax:	DISCONNECT SQUAREWAVE i
Range:	
Describe:	Disconnect the software generated squarewave generator from an associated digital output pin. The pin reverts to digital input upon

Command:	SQUAREWAVE i
	disconnect.
Result:	Disconnect squarewave function from pin(s), stops squarewave generation.
Type or Addressable Component:	Control

DIGITAL.OUT i

Command:	DIGITAL.OUT i
Command Syntax:	DISCONNECT DIGITAL.OUT i
Range:	
Describe:	Disconnect a generic DIGITAL object. The associated pin is reverted to a digital INPUT pin with no enabled pullup or pulldown. The DIGITAL object number can be used to refer the same pin in either input, or output form...
Result:	Disconnect digital input object.
Type or Addressable Component:	Control/Sensor

BBPORT

Command:	DISCONNECT BBPORT
Command Syntax:	DISCONNECT BBPORT
Range	
Describe:	Disconnects all connected BBPORT object pins, and resets those pins to the default INPUT state, and unused/available for other use.
Result:	The BBPORT object is no longer available for use in the program.
Type or Addressable Component:	Control/Sensor

LIGHT

Command:	LIGHT
Command Syntax:	DISCONNECT LIGHT
Range:	
Describe:	Disconnect the on-board RED LED used for direct program control from the system.
Result:	On-board LED disconnected
Type or Addressable Component:	Control

COLOR

Command:	COLOR
Command Syntax:	DISCONNECT COLOR
Range:	
Describe:	Disconnects the on-board RGB LED item from use. This action (in the

Command:	COLOR
	initial release of the TI-Innovator™) frees three (3) hardware map-able PWM signals for use on other pins..
Result:	Disconnect on-board RGB LED .
Type or Addressable Component:	Control

SOUND

Command:	SOUND
Command Syntax:	DISCONNECT SOUND
Range:	
Describe:	Disconnect the on-board speaker from its digital pin.
Result:	Disconnects on-board speaker.
Type or Addressable Component:	Control

DCMOTOR i

Command:	DCMOTOR i
Command Syntax:	DISCONNECT DCMOTOR i
Range:	
Describe:	Disconnects a DCMOTOR object from the system. DCMOTOR , ANALOG.OUT , and SQUAREWAVE all share the same number space of items. DCMOTOR requires external power.
Result:	Disconnect DCMOTOR from pin.
Type or	Control

Command:	DCMOTOR i
Addressable Component:	

DISCONNECT-Input

DISCONNECT breaks the association between a specified control or sensor and the pin/port it is associated with. If the specified sensor or control is not currently connected to anything, an error is generated.

The **DISCONNECT** command does not generate an active response, other than possible error responses. Pins associated with an actively connected sensor, or control, are released from use and, in general, are set to a digital input state with no enabled pullup/pulldown.

DISCONNECT - disconnect something that has been connected, by index if needed.

Command:	DISCONNECT-Input...
Command Syntax:	DISCONNECT
Range:	
Describe:	Removes the association of a sensor or control with a pin, or set of pins, if such association exists. Places the pin(s) back to an INPUT state.
Result:	.
Type or Addressable Component:	

CE Calculators

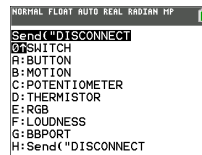
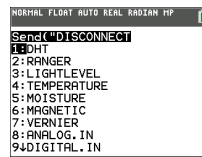

TI-Nspire™ CX

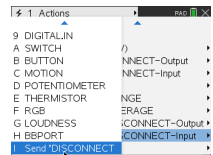
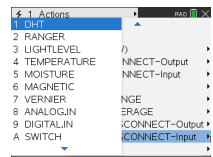

DHT i

Command:	DHT i
Command	DISCONNECT DHT i

Command:	DHT i
Syntax:	
Range:	Temperature reading default is in Celsius Humidity reading from 0 to 100 %
Describe:	Disconnects the specified digital humidity DHT and temperature sensor from the system. This also removes that object from the period scan list of style sensors in the DHT task.
Result:	Digital humidity/temperature sensor(s) disconnected.
Type or Addressable Component:	Sensor

RANGER i

Command:	RANGER i
Command Syntax:	DISCONNECT RANGER i
Range:	
Describe:	Disconnect a digital ultrasonic ranging sensor from the two digital pins it uses.
Result:	Ultrasonic ranging sensor disconnected.
Type or Addressable Component:	Sensor

LIGHTLEVEL i

Command:	LIGHTLEVEL i
Command Syntax:	DISCONNECT LIGHTLEVEL i
Range:	
Describe:	Disconnect an external light sensor.

Command:	LIGHTLEVEL i
Result:	Light sensor disconnected.
Type or Addressable Component:	Sensor

TEMPERATURE i

Command:	TEMPERATURE i
Command Syntax:	DISCONNECT TEMPERATURE i
Range:	Temperature reading default is in Celsius. The range depends on the specific temperature sensor being used. Humidity reading from 0 to 100 %
Describe:	Disconnect a connected temperature sensor from the system. TEMPERATURE sensors can be either analog (thermistor-style). Disconnecting from the analog or digital reverts the associated pins to INPUT.
Result:	Disconnect temperature sensor.
Type or Addressable Component:	Sensor

MOISTURE i

Command:	MOISTURE i
Command Syntax:	DISCONNECT MOISTURE i
Range:	
Describe:	Disconnect an analog moisture sensor.
Result:	Disconnect analog moisture sensors
Type or Addressable Component:	Sensor

MAGNETIC

Command:	DISCONNECT MAGNETIC i
Command Syntax:	DISCONNECT MAGNETIC 1
Range	
Describe:	<p>The MAGNETIC sensor is used to detect the presence of a magnetic field. It uses the Hall effect. It is also known as a Hall effect sensor.</p> <p>The DISCONNECT command removes the sensor from the program.</p>
Result:	The name " MAGNETIC 1 " is now disconnected from the sensor. It cannot be used in the program after a DISCONNECT command.
Type or Addressable Component:	Sensor

VERNIER

Command:	DISCONNECT VERNIER i
Command Syntax:	DISCONNECT VERNIER 1
Range	
Describe:	This command removes the named Vernier device from the program.
Result:	A Vernier analog sensor connected to the TI-Innovator™ Hub through a TI-SensorLink cannot be used in the program after a DISCONNECT command.
Type or Addressable Component:	Sensor

ANALOG.IN i

Command:	ANALOG.IN i
Command Syntax:	DISCONNECT ANALOG.IN i
Range:	
Describe:	Disconnects the connected generic analog input device specified.
Result:	Disconnect generic analog input from pin.
Type or Addressable Component:	Sensor

DIGITAL.IN i

Command:	DIGITAL.IN i
Command Syntax:	DISCONNECT DIGITAL.IN i
Range:	
Describe:	Disconnect a generic DIGITAL object. The associated pin is reverted to a digital INPUT pin with no enabled pullup or pulldown. The DIGITAL object number can be used to refer the same pin in either input, or output form.
Result:	Disconnect digital input object.
Type or Addressable Component:	Control/Sensor

SWITCH

Command:	SWITCH
Command Syntax:	DISCONNECT SWITCH i
Range:	
Describe:	Disconnect a switch from its digital pin. The pin reverts to INPUT

Command:	SWITCH
	state, and the switch is removed from the scanning sequence in the BUTTON task.
Result:	disconnect switch object from pin
Type or Addressable Component:	Sensor

BUTTON i

Command:	BUTTON i
Command Syntax:	DISCONNECT BUTTON i
Range:	
Describe:	Disconnects the specified button object from the system and removes it from the list of scanned buttons/switches in the BUTTON task.
Result:	Digital button/switch is disconnected.
Type or Addressable Component:	Sensor

MOTION i

Command:	MOTION i
Command Syntax:	DISCONNECT MOTION i
Range:	
Describe:	Disconnects a digital PIR (passive infrared) MOTION detector and removes the object from the scanning list in the BUTTON task.
Result:	Disconnect passive I/R motion detectors
Type or	Sensor

Command:	MOTION i
Addressable Component:	

POTENTIOMETER i

Command:	POTENTIOMETER i
Command Syntax:	DISCONNECT POTENTIOMETER i
Range:	
Describe:	Disconnect an analog variable resistor (POTENTIOMETER) from the system
Result:	Disconnect a rotary/linear potentiometer sensors
Type or Addressable Component:	Sensor

THERMISTOR i

Command:	THERMISTOR i
Command Syntax:	DISCONNECT THERMISTOR i
Range:	
Describe:	Disconnect an analog thermistor sensor from the associated pin.
Result:	disconnect analog thermistor
Type or Addressable Component:	Sensor

RGB

Command:	DISCONNECT RGB
Command Syntax:	DISCONNECT RGB
Range	
Describe:	The DISCONNECT command removes the TI-RGB Array from the program.
Result:	The TI-RGB Array cannot be used in the program after a DISCONNECT command.
Type or Addressable Component:	Sensor

LOUDNESS i

Command:	LOUDNESS i
Command Syntax:	DISCONNECT LOUDNESS i
Range:	
Describe:	Disconnect an analog sound intensity (LOUDNESS) sensor.
Result:	Analog sound level sensor disconnected
Type or Addressable Component:	Sensor

BBPORT

Command:	DISCONNECT BBPORT
Command Syntax:	DISCONNECT BBPORT
Range	
Describe:	Disconnects all connected BBPORT object pins, and resets those pins to the default INPUT state, and unused/available for other use.
Result:	The BBPORT object is no longer available for use in the program.
Type or Addressable Component:	Control/Sensor

BRIGHTNESS

Command:	BRIGHTNESS
Command Syntax:	DISCONNECT BRIGHTNESS
Range:	
Describe:	Disconnects the internal connection to the on-board BRIGHTNESS (light sensor) object.
Result:	Disconnect on-board LIGHT sensor.
Type or Addressable Component:	Sensor

MANAGE

The **Manage** menu pastes a **Send()** command with the following management items.

Str0 is displayed on Home Screen with information if requested in the command.

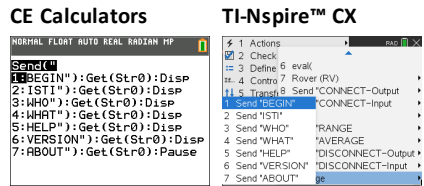

BEGIN

The **BEGIN** command disconnects all connected sensors and controls, re-initializes all sensor/control memory within the sketch, and resets the sensor average default value, error formatting, and flow control defaults. Additionally, all **IN n** port pins, and the breadboard connector (**BB n**) pins are set to the **INPUT** pin mode. All **OUT n** port pins are set to the **INPUT** state, and allowed to float, including **OUT3** which will read as high due to a pullup resistor from the 5V supply on this pin.

When the entire process completes, a response of **READY** is sent to the host system. This response must be waited for by the host before any further operations are performed. Additional commands may be in the command queue to be executed, but will not be acted upon until this command completes.

BEGIN

Command:	BEGIN
Command Syntax:	SEND("BEGIN"
Describe:	Disassociates sensors from ports or pins, and resets all settings back to defaults. Disconnects any connected sensor objects and restores system to state as if RESET button pressed.
Result:	Responds with a " READY " when completed.
Type or Addressable Component:	Not Applicable

Note: The [:] is used to sequence command lines on one command line. The **Manage...** menu pastes a convenient set of commands to then display the information in **Str0** on the home screen.

ISTI

The **ISTI** command is used to synchronize communications with the sketch. The response to this command must be **TISTEM**. Responses may have a leading **NUL** (0) character on initial power-on of the Innovator hub. All responses from the Innovator hub will be followed with a **CR/LF** pair that may or may not be stripped by software layers in the host system prior to the response being received by the application layer on the host system.

ISTI

Command:	ISTI
Command Syntax:	ISTI
Describe:	Send "ISTI", and get response "TISTEM".
Result:	Handshake command used to determine presence of a supported "sketch" on the TI-Innovaotr™ Hub.
Type or Addressable Component:	

WHO

WHO is an identification command (similar to the **ISTI** handshake command below) that can be used to determine what product is present and running the sketch.

The correct response to **WHO** is "**TI INNOVATOR ON MSP432**" when this command is sent to the TI-Innovator Hub.

WHO

Command:	WHO
Command Syntax:	WHO
Describe:	Identification command to determine what product is running the sketch. Send ("WHO") Get Str0 Disp Str0
Result:	Identify the product - TI INNOVATOR ON MSP432.

Command:	WHO
Type or Addressable Component:	

WHAT

The **WHAT** command is an identification command. The response to **WHAT** for TI-Innovator is "**TI INNOVATOR HUB**".

WHAT

Command:	WHAT
Command Syntax:	WHAT
Describe:	Product name query. Identify the product - " TI INNOVATOR HUB " Send ("WHAT") Get Str0 Disp Str0
Result:	Identify the product.
Type or Addressable Component:	

HELP

HELP is used to obtain quick information about each of these commands. The **HELP command-name** is sent, and generates a string response with a one-line description of the given command.

HELP

Command:	HELP
Command Syntax:	HELP
Describe:	Provides per command quick help information. i.e. HELP SET, etc.
Result:	
Type or Addressable Component:	

VERSION

The **VERSION** command has a response that represents the current version of the sketch running on the TI-Innovator™ Hub.

The version will be of the *major.minor.patch.build* form in released products; for example, 1.0.0.

VERSION

Command:	VERSION
Command Syntax:	VERSION
Describe:	Returns version number (and possibly Accurev stream name from which sketch was built).
Result:	Report the version of the sketch in format <i>major.minor.patch.build</i> . Send ("VERSION") Get Str0 Disp Str0
Type or Addressable Component:	

ABOUT

The **ABOUT** command response is the product line name along with a copyright date and owner. The current response to this command is "**TI INNOVATOR (C)2015-2016 TEXAS INSTRUMENTS**".

ABOUT

Command:	ABOUT
Command Syntax:	ABOUT
Describe:	Product name and copyright information returned. Send ("ABOUT") Get Str0 Disp Str0
Result:	Returns copyright string. " TI INNOVATOR (C)2015-2016 TEXAS INSTRUMENTS "
Type or Addressable Component:	

COLLECT

Use the **COLLECT** and **READ LIST** commands to:

- Collect up to 10 samples per second
- From up to 4 sensors (the Digital Humidity and Temperature – DHT – sensor counts as 2 sensors)
- The sensors can be a mix of Vernier sensors (through TI Sensor Link) and Seed sensors

Note:

- Data is collected through programs in TI-Basic and Python
- Data can be saved in lists
- No integration with Vernier DataQuest (TI-Nspire™ CX) & EzData (TI-8x CE family)

COLLECT

Command:	COLLECT <sensor1> AND <sensor2> TIME t RATE r
Command Syntax:	COLLECT <sensor1> AND <sensor2> TIME t RATE r
Default value:	Default value of for TIME : 10 seconds Default value of rate: 4 (samples/second)
Range:	Maximum 4 sensors Range for TIME : 1 - 100 (seconds) Range for RATE : 1 - 10 (samples per second)
Code Sample:	TI-Nspire™: Send "CONNECT TEMPERATURE 1 TO IN 1" Send "COLLECT TEMPERATURE 1 TIME 5 RATE 4" Wait 6 Send "READ LIST TEMPERATURE 1" Get listtemp Send "READ LIST TIME" Get listtime
Code Sample:	CE family: Send("COLLECT BRIGHTNESS RATE 5 TIME 5") Wait 6 Send("READ LIST BRIGHTNESS") Get (L ₁) Send("READ LIST TIME") Get (L ₂)

Command:	COLLECT <sensor1> AND <sensor2> TIME t RATE r
	Disp L ₁ Disp L ₂
Describe:	
Result:	The " READ LIST TIME " command will return the sample times corresponding to the sensor sample values. Each " READ LIST " command returns a maximum of 64 data points. For collections that exceed 64 samples, the program will have to use the " READ LIST " command multiple times and combine the resulting lists.
Type or Addressable Component:	This command can be used with most sensors. It cannot be used with many I2C sensors or the RV.COLORINPUT and RV.GYRO sensors built-in to TI-Innovator™ Rover. This command will work with the RV.RANGER sensor.

For collections that exceed 64 samples, the program will have to use the "**READ LIST**" command multiple times and combine the resulting lists.

Example:

1. This TI-Nspire™ program will collect 10 samples per second from a temperature sensor for 10 seconds – a total of 101 samples.

Code Sample:	<pre> Send "CONNECT TEMPERATURE 1 TO IN 1" Send "COLLECT TEMPERATURE 1 TIME 10 RATE 10" Wait 11 Send "READ LIST TEMPERATURE 1" Get readbuffer listtemp1:=readbuffer While dim(readbuffer)=64 **Send "READ LIST TEMPERATURE 1" **Wait 0.2 **Get readbuffer **listtemp1:=augment(listtemp1,readbuffer) EndWhile Send "READ LIST TIME" Get readbuffer listtime:=readbuffer While dim(readbuffer)=64 ** Send "READ LIST TIME" **Wait 0.2 **Get readbuffer **listtime:=augment(listtime,readbuffer) EndWhile </pre>
---------------------	--

The 'Wait 0.2' command between the 'Send' and the 'Get' commands is needed to ensure that all of the data makes it to the program before the next batch is read.

This delay is only needed on the TI-Nspire™ CX and TI-Nspire™ CX II handhelds.

2. This CE program collects 8 samples per second for 10 seconds from the built-in **BRIGHTNESS** sensor. The total number of samples will be 81 so the program will have to use **READ LIST** twice to get all the samples and then combine the lists.

Code Sample:	<pre> Send("COLLECT BRIGHTNESS RATE 8 TIME 10") Wait 11 Send("READ LIST BRIGHTNESS") Get(L1) Send("READ LIST BRIGHTNESS") Get(L2) Send("READ LIST TIME") Get(L3) Send("READ LIST TIME") Get(L4) augment(L1,L2)→L1 augment(L3,L4)→L3 Disp dim(L1) Disp dim(L3) Disp L1 Disp L3 </pre>
---------------------	--

3. This TI-Nspire™ program collects samples from 2 sensors.

Code Sample:	<pre> Send "CONNECT DHT1 TO IN 1" Send "CONNECT VERNIER 1 TO IN 2 AS PRESSURE" Send "COLLECT DHT 1 AND VERNIER 1 TIME 10 RATE 4" @ This will collect 41 samples for each sensor WAIT 10 Send "READ LIST DHT1 TEMPERATURE" Get list1 Send "READ LIST DHT1 HUMIDITY" Get list2 Send "READ LIST VERNIER 1" Get list3 Send "READ LIST TIME" Get list4 </pre>
---------------------	--

Note:

1. The **COLLECT** command cannot be used for some **RV** sensors like **RV.GYRO** or **RV.COLORINPUT**. It will work with **RV.RANGER**

It can be used with sensors connected to the Hub while the Hub is in TI-Innovator™ Rover.

2. The data collection starts as soon as the command is processed.
3. If a **READ LIST** command is issued during an active collection, an error is indicated.
4. Other **SET & READ** commands can be processed while a **COLLECT** is in progress as long as the **READ** command doesn't use a sensor that's part of the **COLLECT** command.
5. The **AVERAGING** command will affect the data collected with a **COLLECT** command only if it is issued before the **CONNECT** commands. See the documentation for the **AVERAGING** command.

READ COLLECT

Command:	READ COLLECT
Command Syntax:	READ COLLECT
Default value:	
Range:	
Describe:	
Result:	Returns: 0 - no active collection in progress 1 - active collection in progress
Type or Addressable Component:	This command can be used with most sensors. It cannot be used with many I2C sensors or the RV.COLORINPUT and RV.GYRO sensors built-in to TI-Innovator™ Rover. This command will work with the RV.RANGER sensor.

Note:

1. The **COLLECT** command cannot be used for some **RV** sensors like **RV.GYRO** or **RV.COLORINPUT**. It will work with **RV.RANGER**

It can be used with sensors connected to the Hub while the Hub is in TI-Innovator™ Rover.

2. The data collection starts as soon as the command is processed.
3. If a **READ LIST** command is issued during an active collection, an error is indicated.
4. Other **SET & READ** commands can be processed while a **COLLECT** is in progress as long as the **READ** command doesn't use a sensor that's part of the **COLLECT** command.

5. The **AVERAGING** command will affect the data collected with a **COLLECT** command only if it is issued before the **CONNECT** commands. See the documentation for the **AVERAGING** command.

Additional Supported Commands

The following sets of supported commands are not found in the Hub Menus.

Additional SET Commands

FORMAT ERROR STRING/NUMBER

Command:	FORMAT ERROR STRING/NUMBER Advanced user
Command Syntax:	SET FORMAT ERROR STRING/NUMBER
Range:	
Describe:	Used for setting error return format and optional audible tone on error. SET FORMAT ERROR STRING/NUMBER – returned error codes in string or numeric format.
Result:	Sets the format for the return of error information (numbers, or strings).
Type or Addressable Component:	Setting

FORMAT ERROR NOTE/QUIET

Command:	FORMAT ERROR NOTE/QUIET Advanced user
Command Syntax:	SET FORMAT ERROR NOTE/QUIET
Range:	
Describe:	Used for setting error return format and optional audible tone on error.

Command:	FORMAT ERROR NOTE/QUIET Advanced user
	SET FORMAT ERROR NOTE/QUIET – error display flash accompanied by speaker sound or no sound.
Result:	Enables tones, or disables tones in addition to the string/number reporting above.
Type or Addressable Component:	Setting

FLOW [TO] ON/OFF

Command:	FLOW [TO] ON/OFF Advanced user
Command Syntax:	SET FLOW [TO] ON/OFF
Range:	
Describe:	Enables (ON) or disables (OFF) the software flow control mechanism between the sketch and the communications hardware. NOTE: When the SEGDISP module is CONNECTED , this setting determines whether or not the display module shows error information (flow control disabled), or command queue depth (flow control enabled).
Result:	Turn on xon/xoff flow control, or turn off (no flow control)
Type or Addressable Component:	Setting

OUT1/2/3 [TO]

Command:	OUT1/2/3 [TO]
Command Syntax:	OUT1/2/3 [TO] ... SET OUTn 0-255 SET OUTn HIGH/ON SET OUTn LOW/OFF
Range:	Set analog PWM value on OUT port(s) of the TI-Innovator™ Hub
Describe:	Direct output of information to a given output port. These are PWM outputs on the TI-Innovator™ Hub. Set analog PWM value on TI-Innovator™ Hub OUT port(s). SET OUTn 0-255 – 0=off, 255=on, anything else is a PWM signal @ 500 Hz with duty cycle high from 1 to 254, where that range provides a percentage of the high-time signal of the waveform. SET OUTn HIGH/ON – same as 255 SET OUTn LOW/OFF – same as 0
Result:	Set analog PWM value on OUT port(s) of the TI-Innovator™ Hub
Type or Addressable Component:	Port

BUZZER i

Command:	BUZZER i
Command Syntax:	READ BUZZER i
Range:	
Describe:	Returns the current state of the active buzzer specified; 0 = <i>silent</i> , 1 = <i>playing tone</i> .
Result:	Returns state of active buzzer, 0=silent, 1=on
Type or Addressable Component:	Control

COLOR

Command:	COLOR
Command Syntax:	READ COLOR
Range:	
Describe:	<p>Read the current output state of the on-board COLOR RGB LED with sub-components .RED, .GREEN, .BLUE. When reading the entire item, a list of three values is returned, with values between 0 and 255 where 0=off, 255=full on, and values in between indicate PWM levels.</p> <p>READ COLOR – returns list of 3 values representing { red, green, blue } PWM levels</p> <p>READ COLOR.RED</p> <p>READ COLOR.GREEN</p> <p>READ COLOR.BLUE</p> <p>See Also: RGB i</p>

Command:	COLOR
Result:	Returns list of 3 values representing { red, green, blue } PWM levels. Returns RED/GREEN/BLUE values for on-board RGB (color) LED .
Type or Addressable Component:	Control

COLOR.RED

Command:	COLOR RED
Command Syntax:	READ COLOR.RED
Range:	
Describe:	Read the current output state of the on-board COLOR RGB LED with sub-components .RED, .GREEN, .BLUE . When reading the entire item, a list of three values is returned, with values between 0 and 255 where 0=off, 255=full on, and values in between indicate PWM levels. READ COLOR.RED
Result:	Returns values representing {red} PWM levels. Returns RED values for on-board RGB (color) LED .
Type or Addressable Component:	Control

COLOR.GREEN

Command:	COLOR GREEN
Command Syntax:	READ COLOR.GREEN

Command:	COLOR GREEN
Range:	
Describe:	Read the current output state of the on-board COLOR RGB LED with sub-components .RED , .GREEN , .BLUE . When reading the entire item, a list of three values is returned, with values between 0 and 255 where 0=off, 255=full on, and values in between indicate PWM levels. READ COLOR.GREEN
Result:	Returns list of 3 values representing { red, green, blue } PWM levels. Returns RED/GREEN/BLUE values for on-board RGB (color) LED .
Type or Addressable Component:	Control

COLOR.BLUE

Command:	COLOR BLUE
Command Syntax:	READ COLOR.BLUE
Range:	
Describe:	Read the current output state of the on-board COLOR RGB LED with sub-components .RED , .GREEN , .BLUE . When reading the entire item, a list of three values is returned, with values between 0 and 255 where 0=off, 255=full on, and values in between indicate PWM levels. READ COLOR.BLUE
Result:	Returns list of 3 values representing { red, green, blue } PWM levels. Returns RED/GREEN/BLUE values for on-board RGB (color) LED .
Type or Addressable Component:	Control

DCMOTOR i

Command:	DCMOTOR i
Command Syntax:	READ DCMOTOR i
Range:	
Describe:	Motor that converts direct current electrical power into mechanical power.
Result:	Returns whether dcmotor is running (1) or stopped (0).
Type or Addressable Component:	Control

DIGITAL.OUT i

Command:	DIGITAL.OUT i
Command Syntax:	READ DIGITAL.OUT i
Range:	
Describe:	Returns the current state of the digital pin connected to the DIGITAL object, or the cached state of the digital output value last SET to the object.
Result:	Return 0 (output low), 1 (output high).
Type or Addressable Component:	Control/Sensor

FORMAT

Command:	FORMAT Advanced user
Command Syntax:	READ FORMAT
Range:	
Describe:	Return the current formatting flags for error reporting. The value returned is a byte value indicating various flags. Masking with values indicates what error reporting options are active. 1 = ERROR strings reported 2 = ERROR numbers reported +4 = ERROR TONE enabled, if not set, errors are reported silently.
Result:	Read error format (1=strings, 2=numbers, +4 to either: tones enabled).
Type or Addressable Component:	Setting

FLOW

Command:	FLOW Advanced user
Command Syntax:	READ FLOW
Range:	
Describe:	Returns the current flow control setting; 0= <i>disabled</i> , 1= <i>enabled</i> .
Result:	Read current flow control, 0 = none, 1 = xon/xoff
Type or Addressable Component:	Setting

IN1/IN2/IN3

Command:	IN1/IN2/IN3
Command Syntax:	READ IN1 READ IN2 READ IN3
Range:	
Describe:	Read the value present on the indicated port, and return that value to the host.
Result:	Read value of analog port on TI STEM board
Type or Addressable Component:	Port

LAST ERROR

Command:	LAST ERROR
Command Syntax:	READ LAST ERROR
Range:	
Describe:	Returns the last reported error from the last operation. Depending on the FORMAT ERROR setting, the response may be a STRING or a NUMBER .
Result:	Return last encountered error, resets automatically to 0, no error.
Type or Addressable Component:	Setting

LED i

Command:	LED i
Command Syntax:	READ LED i
Range:	
Describe:	Read the current state of the specified LED . If the LED is digital, a 0 or 1 is returned indicating the LED is off or on. If the LED is connected to a PWM output, a value from 0 to 255 will be returned, indicating the current PWM level where 0 is off, 255 is full on, and values in between indicate the current PWM setting.
Result:	Get state of LED , 0 or 1 if digital, 0-255 if PWM on analog.
Type or Addressable Component:	Control

LIGHT

Command:	LIGHT
Command Syntax:	READ LIGHT
Range:	
Describe:	Returns the state of the on-board RED LED (digital only). A value of 0 is off, and 1 is on.
Result:	Get current state of on-board red LED (0=off, 1=on).
Type or Addressable Component:	Control

OUT1/2/3

Command:	OUT1/2/3
Command Syntax:	READ OUT1 READ OUT2 READ OUT3
Range:	
Describe:	Read value of current port as input (may be a digital read since these do not support analog-input). READ OUT1/OUT2/OUT3
Result:	Read value of analog port on TI STEM board.
Type or Addressable Component:	Port

PWR

Command:	PWR
Command Syntax:	READ PWR
Range:	
Describe:	Returns the current state of presence of external power connected to the PWR port. The PWR port is read, and a status value of 0 (not present) or 1 (present) is returned, based on whether or not external power is available. READ PWR
Result:	Returns state of external power presence on PWR port (0=not present, 1=ext pwr present).
Type or Addressable Component:	Status

RELAY i

Command:	RELAY i
Command Syntax:	READ RELAY i
Range:	
Describe:	Return the current state of the specified relay. 0 = OFF, 1 = ON.
Result:	Read state of relay - 0=not active 1=active.
Type or Addressable Component:	Control

RESOLUTION

Command:	RESOLUTION
Command Syntax:	READ RESOLUTION
Range:	
Describe:	Returns the bit resolution used by the system for ADC readings.
Result:	Returns ADC resolution in use, in bits (default is 14).
Type or Addressable Component:	Setting

RGB i

Command:	RGB i
Command	READ RGB i

Command:	RGB i
Syntax:	
Range:	
Describe:	<p>Same as the COLOR object referenced above, and has sub-objects named RED, GREEN, and BLUE. This command returns the current PWM level that the specified object is using.</p> <p>READ RGB i – returns a 3 element list, consisting of the { red, green, blue } color level.</p> <p>READ RED i – returns just the current red-component level.</p> <p>READ GREEN i</p> <p>READ BLUE i</p>
Result:	Get state of RGB LED , {r,g,b} list values
Type or Addressable Component:	Control

RED i

Command:	RED i
Command Syntax:	READ RED i
Range:	
Describe:	<p>Same as the COLOR object referenced above, and has sub-objects named RED, GREEN, and BLUE. This command returns the current PWM level that the specified object is using.</p> <p>READ RGB i – returns a 3 element list, consisting of the { red, green, blue } color level.</p> <p>READ RED i – returns just the current red-component level.</p>
Result:	Get state of RGB RED component.
Type or Addressable Component:	Control

GREEN i

Command:	GREEN i
Command Syntax:	READ GREEN i
Range:	
Describe:	Same as the COLOR object referenced above, and has sub-objects named RED , GREEN , and BLUE . This command returns the current PWM level that the specified object is using. READ RGB i – returns a 3 element list, consisting of the { red, green, blue } color level. READ GREEN i – returns just the current green-component level.
Result:	Get state of RGB GREEN component.
Type or Addressable Component:	Control

BLUE i

Command:	BLUE i
Command Syntax:	READ BLUE i
Range:	
Describe:	Same as the COLOR object referenced above, and has sub-objects named RED , GREEN , and BLUE . This command returns the current PWM level that the specified object is using. READ RGB i – returns a 3 element list, consisting of the { red, green, blue } color level. READ BLUE i – returns just the current blue-component level
Result:	Get state of RGB BLUE component.
Type or Addressable Component:	Control

SERVO i

Command:	SERVO i
Command Syntax:	READ SERVO i
Range:	
Describe:	Returns the current position of a sweep servo in the range -90 to 90, OR the current speed of rotation of a continuous servo motor. Additionally, the current "calibration" setting for the servo which consists of a 2-element list representing the lower and upper microsecond pulse widths corresponding to the sweep/rotation ranges may be read. READ SERVO i – get current sweep position or rotation speed/direction. READ SERVO i CALIBRATION – get current microsecond range for sweep or rotation.
Result:	Return current servo position in degrees from -90 to +90.
Type or Addressable Component:	Control

SERVO i CALIBRATION

Command:	SERVO i CALIBRATION Advanced user
Command Syntax:	READ SERVO i CALIBRATION
Range:	
Describe:	Returns the current position of a sweep servo in the range -90 to 90, OR the current speed of rotation of a continuous servo motor. Additionally, the current "calibration" setting for the servo which consists of a 2-element list representing the lower and upper microsecond pulse widths corresponding to the sweep/rotation ranges may be read. READ SERVO i CALIBRATION – get current microsecond range for sweep or rotation.

Command:	SERVO i CALIBRATION Advanced user
Result:	Return current servo position in degrees from -90 to +90.
Type or Addressable Component:	Control

SOUND

Command:	SOUND
Command Syntax:	READ SOUND
Range:	
Describe:	Returns a value indicating whether sound is currently being played (1) or not (0) through the on-board speaker.
Result:	Return whether on-board speaker is playing a tone (1) or is silent(0).
Type or Addressable Component:	Control

SPEAKER i

Command:	SPEAKER i
Command Syntax:	READ SPEAKER i
Range:	
Describe:	Returns a value indicating whether sound is currently being played (1) or not (0) through an external speaker.

Command:	SPEAKER i
Result:	Return whether speaker is playing a tone (1) or silent (0).
Type or Addressable Component:	Control

SQUAREWAVE i

Command:	SQUAREWAVE i
Command Syntax:	READ SQUAREWAVE i
Range:	
Describe:	Returns a 0 the current squarewave object is not active. A value of 1 is returned if the object is actively generating an output.
Result:	Returns whether squarewave is active (1) or not active (0).
Type or Addressable Component:	Control

PERIOD n

Command:	PERIOD n
Command Syntax:	PERIOD n
Range:	
Describe:	The AVERAGE command is somewhat unique for PERIOD in that it specifies how many distinct periods are to be measured and averaged together to obtain the desired measurement. Up to 25 samples may be taken to obtain the period measurement for a given pin.
Result:	Set number of samples of frequency to take to be average together to generate period.
Type or Addressable Component:	Sensor

CALIBRATE

CALIBRATE is used to set various sensor and control values that do not otherwise fit within a means of setting any other way. For thermistors and temperature sensors that use an analog input port, it can be used to adjust the coefficients of the Steinhart-Hart equation used to map thermistor readings to temperature values. For servo motors, it is used to adjust the PWM pulse width within the range for a servo motor, where the zero position is set at 1500 microseconds. It is also used to set the calibration frequency for the DDS signal generator module (default is 24MHz).

For sensors supporting calibration, the value(s) may be obtained by **READ sensor [i] CALIBRATION**.

SERVO i / SERVO.CONTINUOUS i

Command:	SERVO i /SERVO.CONTINUOUS i minimum maximum Advanced user
Command Syntax:	CALIBRATE SERVO i minimum maximum
Code Sample:	
Range:	
Describe:	<p>Servos operate by using pulse modulation where the high pulse width determines both direction of servo operation and possibly the speed of operation. The time between pulses is generally 20 milliseconds and is not adjustable by this command. The pulse width generally varies around a mid-point of 1.5 milliseconds (1500 microseconds). Pulse widths less than 1.5 milliseconds cause servo operation in one direction, while pulse widths greater than 1.5 milliseconds cause operation in the opposite direction.</p> <p>The CALIBRATE command for SERVO allows programmable changes to the minimum and maximum pulse widths. Parameters are pulse width times in microseconds.</p> <p>Current defaults are minimum 600 and maximum 2400 microseconds.</p>

Command:	SERVO i /SERVO.CONTINUOUS i minimum maximum Advanced user
Result:	Set minimum and maximum pulse width for servo motor, values in microseconds, default 600 and 2400.
Type or Addressable Component:	Control

TEMPERATURE i C1 C2 C3 R1

Command:	TEMPERATURE i C1 C2 C3 R1 Advanced user
Command Syntax:	CALIBRATE TEMPERATURE i C1 C2 C3 R1
Range:	
Describe:	The CALIBRATE command for analog temperature sensors allows changing the default Steinhart-Hart equation coefficients to match those of the thermistor element in the sensor being used. The default values are: C1: 8.76741e-8 C2: 2.34125e-4 C3: 1.129148e-3 R1: 10000.0 (reference resistor value = 10kΩ)
Result:	When using an analog-style thermistor temperature sensor.
Type or Addressable Component:	Sensor

THERMISTOR i C1 C2 C3 R1

Command:	THERMISTOR i C1 C2 C3 R1 Advanced user
Command Syntax:	CALIBRATE THERMISTOR i C1 C2 C3 R1
Range:	
Describe:	The CALIBRATE command for analog thermistors allows changing the default Steinhart-Hart equation coefficients to match those of the thermistor element in the sensor being used. The default values are: C1: 1.33342e-7 C2: 2.22468e-4 C3: 1.02119e-3 R1: 15000.0 (reference resistor value = 15k Ω)
Result:	Where c1/c2/c3 are float constants for the Steinhart-Hart equation. ... that models the thermistor, and r is resistance for the reference. ... resistor used to create a voltage divider with the thermistor.
Type or Addressable Component:	Sensor

TI-Innovator™ Hub Data Sheets

The TI-Innovator™ Hub Data Sheets include the following; a product name and number, a brief description, a product image, specifications, on-board components function, and Hub commands with simple code samples.

Topic Links

- TI-Innovator™ Hub Data Sheet
 - TI-Innovator™ Hub Ports and Breadboard Usable Pins
- TI-Innovator™ Hub On-Board Component Data Sheets
 - On-Board RGB LED Data Sheet
 - On-Board Red LED Data Sheet
 - On-Board Speaker Data Sheet
 - On-Board Light Brightness Sensor Data Sheet
 - On-Board - Auxiliary Power Indicator Data Sheet
 - On-Board Green LED - Power Indicator Data Sheet
 - On-Board Red LED - Error Indicator Data Sheet
- USB Mini A to Mini B Cable Data Sheet
- USB Standard A to Mini B Cable Data Sheet
- USB Standard A to Micro B Cable Data Sheet
- TI Wall Charger Data Sheet
- External Battery Data Sheet

TI-Innovator™ Hub Data Sheet



Title	TI-Innovator™ Hub
TI Item Name	STEM/BK/B
Description	Use the TI-Innovator™ Hub with your compatible TI graphing calculator or TI-Nspire™ software to control components, read sensors, and create powerful learning experiences.
Category	Hub
Hub Connection	Not Applicable
Assembly Instructions	Not Applicable
Precautions	<p>Do not expose the Hub to temperatures above 140F (60C).</p> <p>Do not disassemble or mistreat the Hub.</p> <p>Do not chain together multiple Hubs through the I/O ports or the Breadboard Connector.</p> <p>Use only the USB cables provided with the Hub.</p> <p>Use only the TI provided power supplies:</p> <ul style="list-style-type: none">• TI Wall Charger included with the TI-Innovator™ Hub• Optional External Battery 4-AA battery holder included in the TI-Innovator™ Breadboard Pack <p>Ensure that the components receiving power from the Hub do not exceed the Hub's 1-amp power limit.</p> <p>Avoid using the Hub to control AC electricity.</p> <p>See also: TI-Innovator™ Hub Ports and Breadboard Usable Pins</p>
Specifications	See the TI-Innovator™ Hub specifications section of education.ti.com/go/innovator .

TI-Innovator™ Hub Ports and Breadboard Usable Pins

Breadboard Connector Characteristics

Different pins on the breadboard connector have different capabilities.

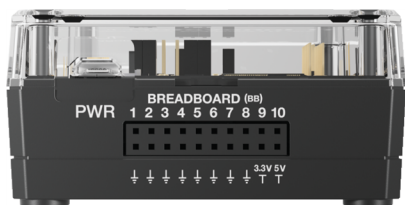

Pin	Digital I/O	Pulse Width Modulation (PWM)	ANALOG IN
BB1	Y		
BB2	Y		
BB3	Y		
BB4	Y	Y	
BB5	Y		Y
BB6	Y		Y
BB7	Y		Y
BB8	Y	Y	
BB9	Y	Y	
BB10	Y	Y	

TI-Innovator™ Hub On-Board Component Data Sheets

Topic Links

- On-Board RGB LED Data Sheet
- On-Board Red LED Data Sheet
- On-Board Speaker Data Sheet
- On-Board Light Brightness Sensor Data Sheet
- On-Board - Auxiliary Power Indicator Data Sheet
- On-Board Green LED - Power Indicator Data Sheet
- On-Board Red LED - Error Indicator Data Sheet

On-Board RGB LED Data Sheet

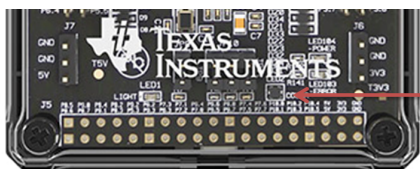

On-Board RGB LED
(LED2)

Title	On-Board RGB LED
TI Item Name	Built into the Hub
Description	Built-in light-emitting diode (LED) that is capable of emitting a variety of colors when current passes through it.
Category	LEDs and Displays
Hub Connection	on-board Hub
Assembly Instructions	Not Applicable
Precautions	Not Applicable
Specifications	Not Applicable

HUB Commands

Sketch Object	COLOR
Command Syntax	Send("SET COLOR ...") ON/OFF/0-255 (red element) ON/OFF/0-255 (green element) ON/OFF/0-255 (blue element)

HUB Commands

[BLINK frequency] (in Hz)

[TIME duration] (in seconds)

Code Sample:	Desired Action	Code Sample
	Turn ON Red and Green elements of tri-color LED	<code>Send("SET COLOR ON ON OFF")</code>
	Set Red to full intensity, Green to half intensity, Blue to off	<code>Send("SET COLOR 255 128 0")</code>
	Set Red to full intensity, Green to half intensity, Blue to off for 10 seconds	<code>Send("SET COLOR 255 128 0 TIME 10")</code>
	Set Red to full intensity, Green to half intensity, Blue to off and blink them at 2 Hz (2 times a second) for 10 seconds	<code>Send("SET COLOR 255 128 0 BLINK 2 TIME 10")</code>
	Turn OFF the Red element	<code>Send("SET COLOR.RED 0")</code>
	Turn ON the Green element at half intensity and blink it at 2 Hz for 10 seconds	<code>Send("SET COLOR.GREEN 128 BLINK 2 TIME 10")</code>

On-Board Red LED Data Sheet

On-Board RED LED
(LED1)

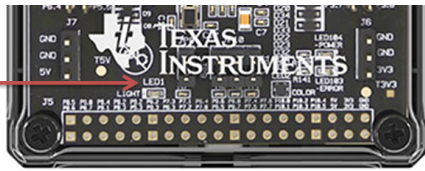

Title	On-Board Red LED
TI Item Name	Built into the Hub
Description	Built-in light-emitting diode (LED) that emits a red light when current passes through it.
Category	LEDs and Displays
Hub Connection	on-board Hub
Assembly Instructions	Not Applicable
Precautions	Not Applicable
Specifications	Not Applicable

HUB Commands

Sketch Object	LIGHT
Command Syntax	Send("SET LIGHT ...") ON/OFF [BLINK frequency] [TIME duration] (in seconds)

Code Sample:	Desired Action	Code Sample
	Turn LED ON	Send("SET LIGHT ON")
	Turn LED OFF	Send("SET LIGHT OFF")
	Turn LED ON for 10 seconds	Send("SET LIGHT ON TIME 10")
	Turn LED ON, blink it at 2 Hz for 10 seconds	Send("SET LIGHT ON BLINK 2 TIME 10")

See Also: [Red LED - Error Indicator](#)

On-Board Speaker Data Sheet



Speaker (at back of Hub) is addressable as "SOUND" in Hub command strings.

Title	On-Board Speaker
TI Item Name	Built into the Hub
Description	Built-in speaker located at the back of the Hub. It converts electrical current into sound you can hear.
Category	Sound Output
Hub Connection	on-board Hub
Assembly Instructions	Not Applicable
Precautions	Not Applicable
Specifications	Not Applicable

HUB Commands

Sketch Object	SOUND
Command Syntax	Send("SET SOUND ...") Frequency in Hz or Note as C1, CS1, D2, ... [TIME duration in seconds]

Code Sample:	Desired Action	Code Sample
	Play tone at 261.23 Hz	<code>Send("SET SOUND 261.23")</code>
	Evaluate the expression 2^8 (= 256) and play that tone	<code>Send("SET SOUND eval (2^8)")</code>
Evaluate the expression 2^8 (= 256) and play that	<code>Send("SET SOUND eval (2^8) TIME .25")</code>	

HUB Commands

	Desired Action	Code Sample
	tone for .25 seconds	
	Evaluate the expression 2^9 (= 512) and play that tone for 0.25 seconds (result of evaluating $1/4$)	<code>Send("SET SOUND eval (2^9) TIME eval (1/4) ")</code>
	Turn speaker off	<code>Send("SET SOUND OFF")</code>

On-Board Light Brightness Sensor Data Sheet

Light Brightness Sensor



Title	On-Board Light Brightness Sensor
TI Item Name	Built into the Hub
Description	Built-in light brightness sensor located at the bottom of the Hub. The sensor detects light intensity.
Category	Environmental Sensors
Hub Connection	on-board Hub
Assembly Instructions	Not Applicable
Precautions	Not Applicable
Specifications	Not Applicable

HUB Commands

Sketch Object	BRIGHTNESS
Command Syntax	Send("READ BRIGHTNESS")

Code Sample:	Desired Action	Code Sample
	Read the built-in light brightness sensor	<pre>Send ("READ BRIGHTNESS") Get (B)</pre>

On-Board - Auxiliary Power Indicator Data Sheet

Auxiliary Power indicator (LED102)



Title	Auxiliary Power Indicator (LED102)
TI Item Name	Built into the Hub
Description	Indicates a Auxiliary power connection.
Category	LEDs and Displays
Hub Connection	on-board
Assembly Instructions	Not Applicable
Precautions	Not Applicable
Specifications	Not Applicable

On-Board Green LED - Power Indicator Data Sheet

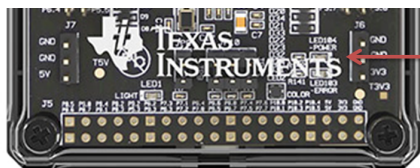

Green LED – Power Indicator
(LED104)

Title	Green LED - Power Indicator
TI Item Name	Built into the Hub
Description	Indicates a USB connection on the DATA port.
Category	LEDs and Displays
Hub Connection	on-board
Assembly Instructions	Not Applicable
Precautions	Not Applicable
Specifications	Not Applicable

On-Board Red LED - Error Indicator Data Sheet

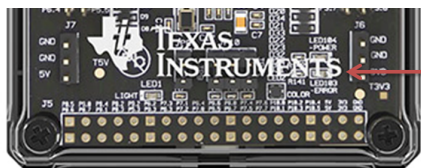

RED LED – Error Indicator
(LED103)

Title	Red LED - Error Indicator
TI Item Name	Built into the Hub
Description	Indicates an error in the sketch command.
Category	LEDs and Displays
Hub Connection	on-board Hub
Assembly Instructions	Not Applicable
Precautions	Not Applicable
Specifications	Not Applicable

See Also: *On-Board Red LED*

USB Mini A to Mini B Cable Data Sheet

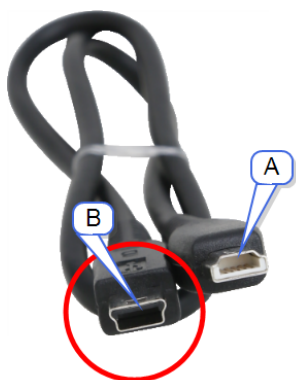

Title	USB Mini A to Mini B Cable
TI Item Name	XX/CA/USB15/A
Description	Connects the Hub to a TI-CE Graphing Calculator or a TI-Nspire™ CX Handheld..
Category	Accessories
Hub Connection	Not Applicable
Assembly Instructions	Not Applicable
Precautions	Not Applicable
Specifications	Not Applicable

USB Standard A to Mini B Cable Data Sheet



Title	USB Standard A to Mini B Cable
TI Item Name	STEM/CA/USB20/A
Description	Connects the Hub to a computer running TI-Nspire™ CX Software.
Category	Accessories
Hub Connection	"B" connector to the USB Mini-B port
Assembly Instructions	Not Applicable
Precautions	Not Applicable
Specifications	Not Applicable

USB Standard A to Micro B Cable Data Sheet



Title	USB Standard A to Micro B Cable
TI Item Name	XX/CA/USB60/C
Description	Connects the Hub to a TI approved power source used with peripherals that require the 5V output port.
Category	Accessories
Hub Connection	"B" connector to the USB Mini-B port
Assembly Instructions	Not Applicable
Precautions	Not Applicable
Specifications	Not Applicable

TI Wall Charger Data Sheet



Title	TI Wall Charger
TI Item Name	XX/AD/9212USB/A
Description	Wall charger that supplies power through the TI-Innovator™ Hub for connected modules that require additional power.
Category	Accessories
Hub Connection	Micro connector of the USB Standard A to Micro B Cable to the PWR connector
Assembly Instructions	Not Applicable
Precautions	Not Applicable
Specifications	Not Applicable

External Battery Data Sheet



Title	External Battery
TI Item Name	STEMBT/A
Description	External battery that supplies power through the TI-Innovator™ Hub for connected modules that require additional power.
Category	Accessories
Hub Connection	Micro connector of the USB Standard A to Micro B Cable to the PWR connector.
Assembly Instructions	Connect to PWR port on TI-Innovator™ Hub
Precautions	Not Applicable
Specifications	Not Applicable

TI-Innovator™ Rover Setup Guide

TI-Innovator™ Rover is a two-wheeled programmable robotic vehicle which works with the TI-Innovator™ Hub with TI LaunchPad™ Board. You communicate with the TI-Innovator™ Hub and control the Rover through TI Basic programming commands. Built-in components include two motors, color sensor, ultrasonic ranger, gyroscope, and RGB LED.

Topics to help you get started include:

- [TI-Innovator™ Rover Overview](#)
- [What's in the Box](#)
- [TI-Innovator™ Rover Setup Requirements](#)
- [Preparing TI-Innovator™ Rover](#)
- [Connecting TI-Innovator™ Rover](#)
- [Exploring the Assembled TI-Innovator™ Rover](#)
- [General Precautions](#)

TI-Innovator™ Rover Overview

TI-Innovator™ Rover is a two-wheeled programmable robotic vehicle which works with the TI-Innovator™ Hub with TI LaunchPad™ Board. You communicate with the Hub and control the Rover through TI Basic programs on one of these TI products:

- TI CE Family of Graphing Calculators (TI-83 Premium CE, TI-84 Plus CE, and TI-84 Plus CE-T) with operating system version 5.3 or later installed. You also need to install or update the Hub App, which contains the Hub menu.
- TI-Nspire™ CX or TI-Nspire™ CX CAS handheld with operating system version 4.5 or later installed
- TI-Nspire™ computer software version 4.5 or later

Follow this guide to setup your TI-Innovator™ Rover with your TI CE Graphing Calculator or TI-Nspire™ CX Handheld.

Learn More

Refer to the [TI-Innovator™ Technology eGuide](#) for more details.

The eGuide is a web-based source of TI-Innovator™ information, including:





- Programming with the TI CE Family of Graphing Calculators and TI-Nspire™ Technology, including sample programs.
- Available I/O Modules and their commands.
- Available Breadboard components and their commands.
- TI-Innovator™ Rover and its commands.
- Link to update the TI-Innovator™ Sketch software.
- Free classroom activities for Hub and Rover.

To access the eGuide, visit <https://education.ti.com/go/eguide/hub/EN>.

For a list of precautions to take while using the Rover and its components, refer to *General Precautions* (page 204).

TI-Innovator™ Rover Setup Requirements

To set up your TI-Innovator™ Rover with your TI-Innovator™ Hub and graphing calculator you will need these materials.

Component	Image	Description
TI-Innovator™ Rover	 A blue two-wheeled robotic vehicle with a small motor and a sensor on top.	A two-wheeled programmable robotic vehicle which works with the Hub.
Breadboard Ribbon Cable	 A flat, multi-colored ribbon cable with a black plastic connector on one end.	Connects the Rover to the Hub's Breadboard Connector.
I ² C Cable	 A thin, multi-colored cable with a small connector on one end.	Connects the Rover to the Hub's I ² C port.
TI-Innovator™ Hub with TI LaunchPad™ Board	 A black rectangular device with a circuit board visible on top, labeled 'TI-Innovator Hub'.	Controls the Rover through TI Basic programming commands.
USB Unit-to-Unit (Mini-A to Mini-B) Cable	 A black cable with a Mini-A connector on one end and a Mini-B connector on the other, labeled 'A' and 'B'.	Included with the Hub. Connects the Hub to a TI CE Graphing Calculator or a TI-Nspire™ CX Handheld.
USB Standard A to Micro Cable	 A black cable with a standard USB-A connector on one end and a micro-USB connector on the other, labeled 'A' and 'Micro'.	Included with the Hub. Connects the PWR port of the Rover to a TI approved power source.
TI CE Graphing Calculator or TI-Nspire™ CX Handheld	 Two TI calculators: a TI CE Graphing Calculator and a TI-Nspire CX Handheld.	Runs TI Basic programs to send commands to the Hub.
TI Wall Charger	 A black rectangular wall charger with a two-prong electrical plug on one end.	Included with the Hub. Power source for charging the Rover.

Preparing TI-Innovator™ Rover

Follow these steps to fully charge your TI-Innovator™ Rover.

1. Identify the Micro connector on the USB Standard A to Micro cable.



2. Insert the Micro connector into the **PWR** port on the side of the Rover.

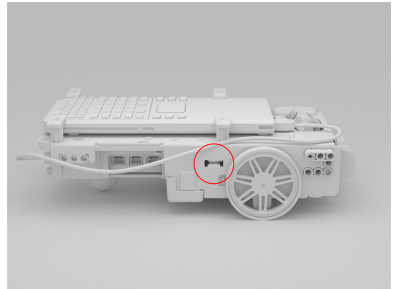

3. Insert the free end of the cable (the "A" connector) into the USB port on your computer or TI Wall Charger.

Note: The Battery Level Indicator shows solid green when the battery is fully charged.



Make sure the TI-Innovator™ Rover is switched **OFF** before connecting to the TI-Innovator™ Hub.

- ▶ Flip the **On/Off (I/O)** switch to the **Off (O)** position.

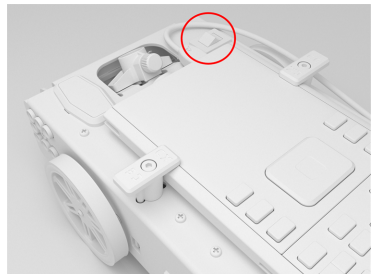

Connecting TI-Innovator™ Rover

There are two sets of connection steps to use the TI-Innovator™ Rover.

- First, connect the Rover to the TI-Innovator™ Hub, using the two ribbon cables provided.
- Second, connect the Hub to a graphing calculator, using the USB Unit-to-Unit (Mini-A to Mini-B) cable included with the Hub.

Connecting TI-Innovator™ Rover to TI-Innovator™ Hub

1. Insert the **Breadboard Ribbon Cable** into the **Breadboard Connector** on the Hub.

Note: It is critical that you insert the cable correctly. Make sure the red (dark) wire pin is inserted into the 5v hole on the Hub's **Breadboard Connector**.



2. Carefully guide the attached Ribbon Cable through the opening at the back of the Rover.
3. As the cable comes through, slide the Hub into place using the **Guide Rails**.

You will hear a click when the Hub is properly inserted.

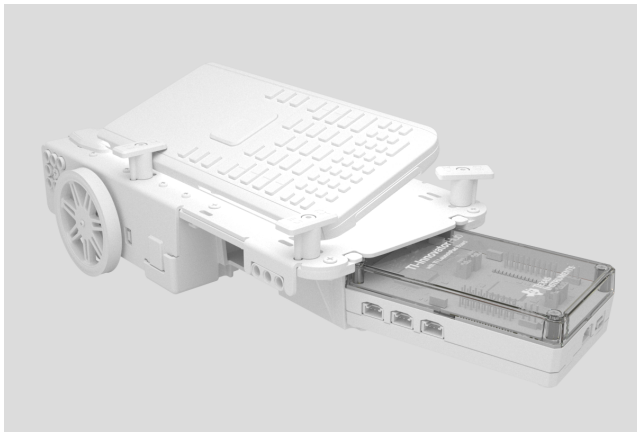

4. Open the two latches on the **Rover Circuit Board Ribbon Cable Connector**.
5. Align the notch in the ribbon cable with the slot on circuit board connector.
6. Insert the ribbon cable and close the latches.

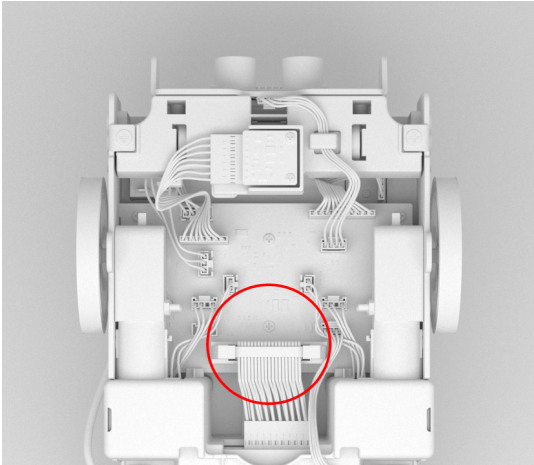

7. Insert one end of the **I²C Cable** into the Rover circuit board.
Note: There are two possible I²C ports. Use **Port 1**.

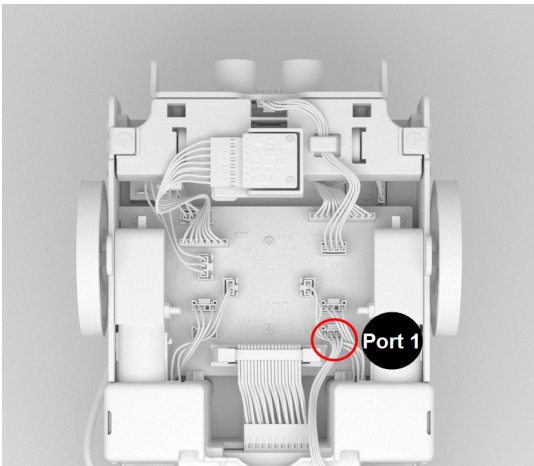

8. Insert the slack **I²C Cable** into the side rails.

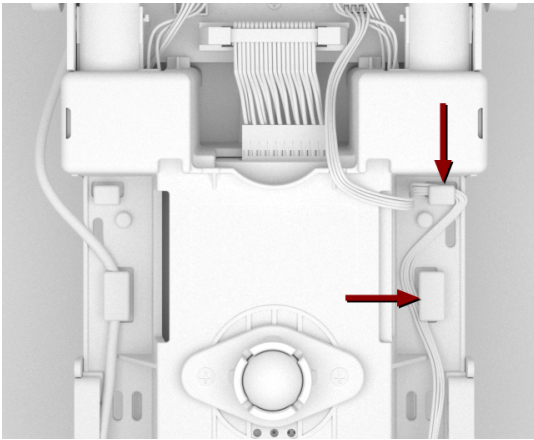

9. Align the tab on the **I²C Cable** with the top of the **I²C port**.
10. Insert the free end of the **I²C Cable** connector into the **I²C port** at the back of the Hub.

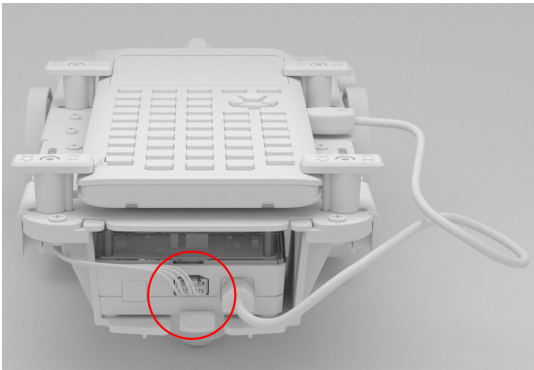

Connecting TI-Innovator™ Hub to a Graphing Calculator

1. Turn the Rover right side up.
2. Lift and turn the **Calculator Holder Pegs** so that they are parallel with the side of the Rover.
3. Place the TI CE Graphing Calculator or TI-Nspire™ CX Handheld on the platform with the screen toward the **Marker Holder**.
4. Turn the pegs so that the CE or CX Label is positioned inward to match the graphing calculator.

The pegs will snap into place when they are positioned correctly.

Caution: Do not turn the **Calculator Holder Pegs** without lifting them first. They could break.

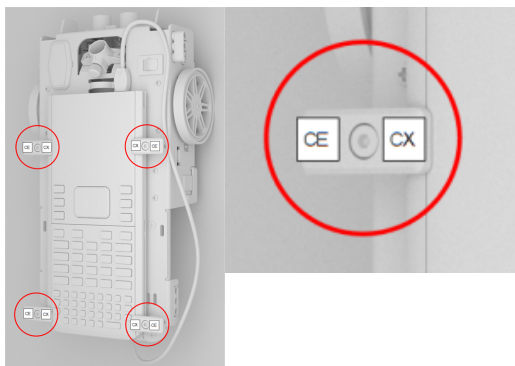

5. Identify the "B" connector on the **USB Unit-to-Unit (Mini-A to Mini-B) cable**. Each end of this cable is embossed with a letter.
6. Insert the "B" connector into the **DATA** port on the Hub.
7. Insert the free end of the cable (the "A" connector) into the USB port on the graphing calculator.

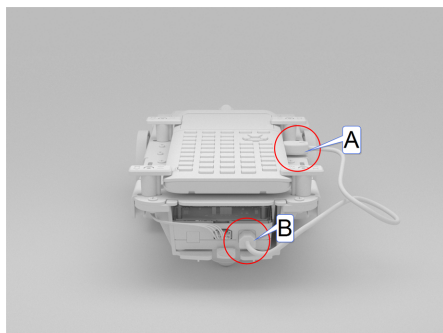

Exploring the Assembled TI-Innovator™ Rover

Explore all sides of the TI-Innovator™ Rover when assembled with the TI-Innovator™ Hub and TI CE Graphing Calculator or TI-Nspire™ CX Handheld connected.

Top Side of the Rover

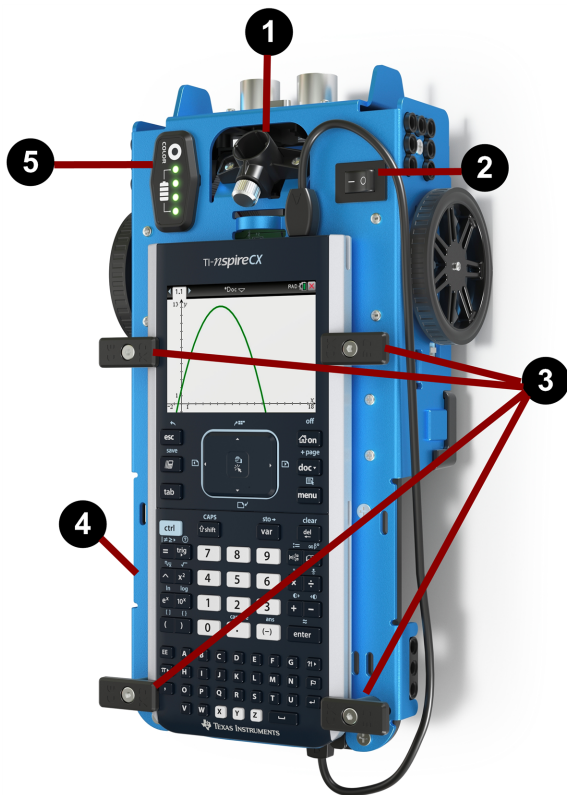

- 1 Marker Holder** - Holds a marker to draw paths.
- 2 ON/OFF (I/O) Switch** - Turns the Rover **ON** (–) or **OFF** (O).
- 3 Calculator Holder Pegs** - Secures a graphing calculator to the calculator platform.
- 4 Calculator Platform** - Holds either a TI CE Graphing Calculator or TI-Nspire™ CX Handheld.
- 5 LED Panel (RGB LED/Battery Level Indicator)** - Displays programmable feedback through the **Red-Green-Blue (RGB) LED**, and displays battery charge level.

Bottom Side of the Rover

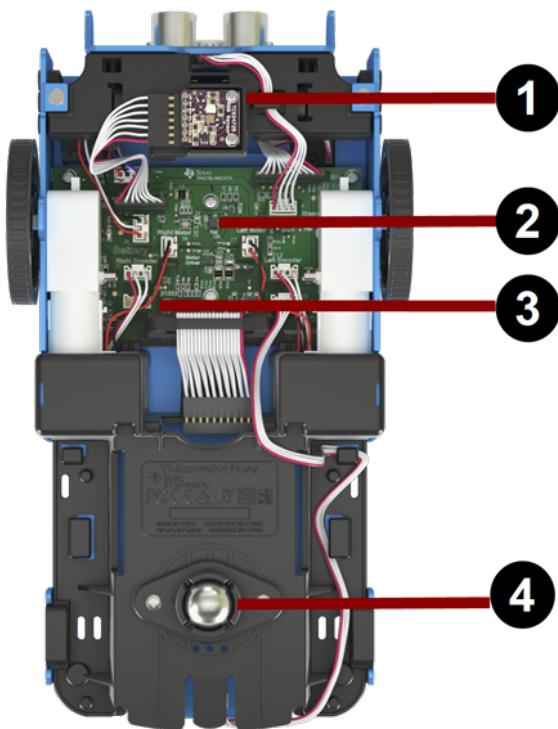

- ① **Color Sensor** - Bottom-mounted color sensor detects the color of the surface. Can also detect gray-level scale of black (0) to white (255).
- ② **Gyroscope** - Measures or maintains orientation.
- ③ **I²C expansion port**.
- ④ **Ball Caster** - Provides smooth movement on hard surface.
Note: Not recommended for use on carpet.

Caution: If you dislodge or disconnect any of the cables, use this image as a reference for correct hookups.

Front Side of the Rover

Ultrasonic Ranger - Measures distance to obstacles.



Back Side of the Rover

Guide Rails - Allows the Hub to slide easily into the Rover and connect to the Rover circuit board.



Note: With the TI-Innovator™ Hub inserted, access a sensor and two ports.

- **Light Brightness Sensor** - Reads as "BRIGHTNESS" in Hub command strings.
 - **I2C port** - Uses I2C cable to connect the Hub to the Rover circuit board.
 - **DATA Mini-B port** - Uses USB Unit-to-Unit (Mini-A to Mini-B) Cable to connect the Hub to a Graphing Calculator.
-

Right Side of the Rover

Access on the Rover:

- **PWR** port - Uses USB Standard A to Micro auxiliary power cable when charging the Rover's Rechargeable battery.
- **Front and Back Mounts** - For adding structures to the Rover using interlocking plastic blocks.



Note: With the Hub inserted, access three ports for controlling output modules.

- **OUT 1** and **OUT 2** provide 3.3V power.
 - **OUT 3** provides 5V power.
-

Left Side of the Rover

Access on the Rover:

- **Front and Back Mounts** - For adding structures to the Rover using interlocking plastic blocks.



Note: With the Hub inserted, access three ports for collecting data or status from input modules.

- **IN 1** and **IN 2** provide 3.3V power.
 - **IN 3** provides 5V power.
-

General Precautions for the TI-Innovator™ Rover

TI-Innovator™ Rover

- Do not expose the Rover to temperatures above 140°F (60°C).
- Do not disassemble or mistreat the Rover.
- Do not put anything heavier than 1 Kg or 2.2 lbs on the Rover platform.
- Use only the USB cables provided with the TI-Innovator™ Hub.
- Use only the Ribbon cables provided with the Rover.
- Use only the TI provided wall charger included with the Hub.
- The front-mounted Ultrasonic Ranger will detect objects within 4 meters of the Rover. For best results make sure the object's surface is bigger than a folder. If used to detect small objects, such as a cup, place the Rover within 1 meter of the object.
- For best results, leave the Slide Case off of your graphing calculator.
- For best performance, use Rover on the floor, not on tables. Damage may occur from Rover falling off a table.
- For best performance, use Rover on a hard surface. Carpet may cause the Rover wheels to catch or drag.
- Do not turn the Holder pegs on the Calculator Platform without lifting them first. They could break.
- Do not use the marker as a lever to pull or push the Rover.
- Do not unscrew the case enclosure on the bottom of the Rover. Encoders have sharp edges that should not be exposed.
- Do not move Rover after executing a program. The internal gyroscope may unintentionally try to get the Rover back on track using the initial location.
- When inserting the Breadboard Ribbon Cable into the Hub Breadboard Connector, it is critical that you insert the cable correctly. Make sure the red (dark) wire pin is inserted into the 5v hole on the Hub's Breadboard Connector.

Caution: If you dislodge or disconnect any of the cables, use this image as a reference for correct hookups. Reference to Bottom View

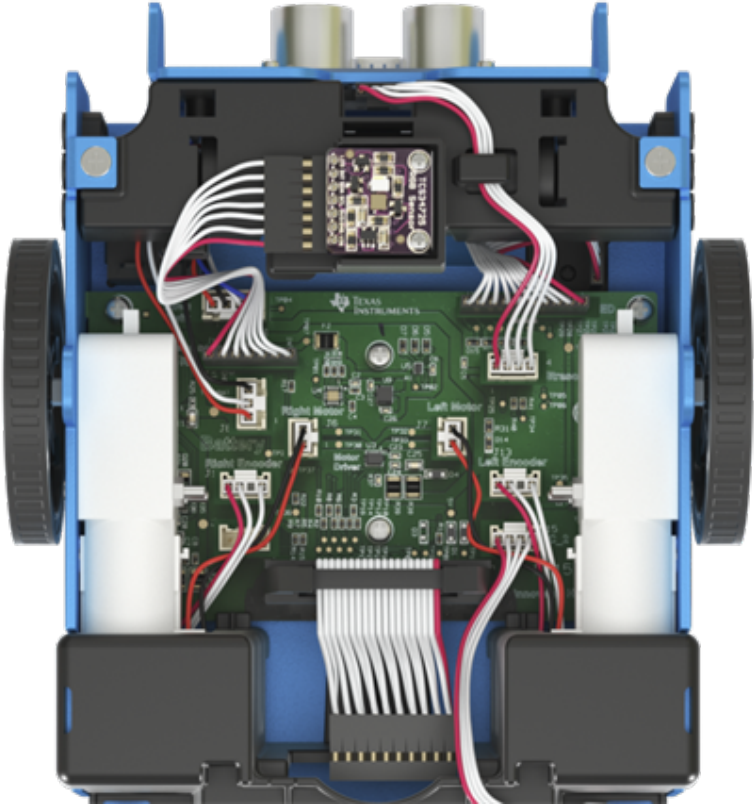

TI-Innovator™ Rover Commands Version 1.5

Prerequisite: Use the Send "Connect RV" Command First

The "CONNECT RV" command needs to be used first when using the Rover. The "CONNECT RV" command configures the TI-Innovator™ Hub software to work with the TI-Innovator™ Rover.

It establishes the connections to the various devices on the Rover – two motors, two encoders, one gyroscope, one RGB LED and one color sensor. It also clears the various counters and sensor values. The optional 'MOTORS' parameter configures only the motors and allows direct control of motors without the additional peripherals.

CONNECT RV - initializes the hardware connections.

- Connects RV and inputs and outputs built into the RV.
- Resets the Path and the Grid Origin.
- Sets the units per meter to default value of 10. Default Grid unit = 10cm.

Named RV Subsystems

The RV object contains several subsystems that are directly addressed by name. These subsystems consist of the wheels, and sensors that let the Rover sense the world.

The subsystems are listed by name in the following table.

Subsystem Name	Description of Subsystem
RV	The RV object as a whole.
RV.COLOR	The tri-color RGB LED on the top surface of the Rover can be controlled through user programs to display any color combination.
RV.COLORINPUT	The color sensor is on the bottom of the Rover and is used to detect the color of the surface.
RV.RANGER	The front-facing ultrasonic distance sensor. Returns measurements in meters. ~10.00 meters means no obstacle was detected.
RV.ENCODERGYRO	The rotary encoders – one on each motor – measure the distance traveled by the Rover. The left and right encoder, coupled with the gyroscope and operating time information.
RV.GYRO	The gyroscope is used to maintain the heading of Rover while it's in motion. It can also be used to measure the change in angle during turns.
RV.MOTOR.L	Left wheel motor and control for direct control (advanced) use.
RV.MOTOR.R	Right wheel motor and control for direct control

Subsystem Name	Description of Subsystem
RV.MOTORS	(advanced) use. Both the LEFT and RIGHT motor, managed as a single object for direct control (advanced) use.

Rover Command Categories

The Rover commands fall into two categories:

1. Queued execution: All of the Rover motion commands – FORWARD, BACKWARD, LEFT, RIGHT, ANGLE – are queued on the TI-Innovator Hub. They may execute at a future time.
2. Immediate execution: Other commands – like the ones to read the sensors or set the RGB LED on the Rover – are executed immediately.

This means that certain statements in your program will execute before statements that appear earlier in the program especially if the latter commands are part of the queued family.

For example, in the program below, the RGB LED will turn RED before the Rover stops moving:

```
Send "SET RV.COLOR 255 0 255" – immediately executed
Send "RV FORWARD 5" – queued command
Send "RV LEFT 45" – queued command
Send "RV RIGHT 90" – queued command
Send "SET RV.COLOR 255 0 0" – immediately executed
```

Example:

To change color after a "FORWARD" movement, use "TIME" parameter with "WAIT".

```
Send "RV FORWARD TIME 5"
WAIT 5
Send "SET RV.COLOR 255 0 255"
```

RV Commands, Code Samples, and Syntax

The following examples show how various commands for the RV are used. Anywhere a **SET** command is used, the **SET** may be left off (optional use).

Code Samples

When you see "**Code Sample**" in a command table, this "**Code Sample**" may be copied and pasted *as is* to send to your graphing calculator to use in your calculations.

Example:

Code Sample:	<pre>Send ("RV FORWARD 5") Send ("RV FORWARD SPEED 0.2 M/S TIME 10")</pre>
---------------------	--

TI-Innovator™ Rover Menu

Rover (RV)...

- Drive RV...
- Read RV Sensors...
- RV Settings...
- Read RV Path...
- RV Color...
- RV Setup...
- RV Control...
- Send("CONNECT RV")
- Send("DISCONNECT RV")

CE Calculators



A screenshot of the TI-Innovator CE Calculators menu. The menu items are: CTL I/O, COLOR EXEC, HUB, 1:Send("SET..."), 2:Send("READ..."), 3:Settings..., 4:Wait, 5:Get(), 6:eval(), 7:Rover (RV)..., 8:Send("CONNECT-Output..."), 9:Send("CONNECT-Input...").

TI-Nspire™ CX

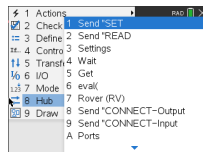

A screenshot of the TI-Nspire CX menu. The menu items are: 1 Actions, 2 Check, 3 Send "SET", 4 Control, 5 Settings, 6 ID, 7 Get, 8 Hub, 9 Draw, 10 Rover (RV), 11 Send "CONNECT-Output", 12 Send "CONNECT-Input", 13 Ports.

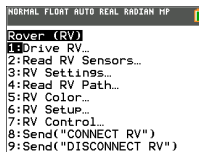

A screenshot of the TI-Innovator CE Calculators menu. The menu items are: NORMAL, FLOAT, AUTO, REAL, RADIAN, MP, Rover (RV)..., 1:Drive RV..., 2:Read RV Sensors..., 3:RV Settings..., 4:Read RV Path..., 5:RV Color..., 6:RV Setup..., 7:RV Control..., 8:Send("CONNECT RV"), 9:Send("DISCONNECT RV").

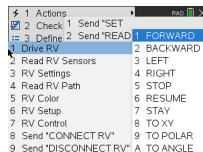

A screenshot of the TI-Nspire CX menu. The menu items are: 1 Actions, 2 Check, 3 Send "SET", 4 Send "READ", 5 Drive RV, 6 Read RV Sensors, 7 RV Settings, 8 Read RV Path, 9 RV Color, 10 RV Setup, 11 RV Control, 12 Send "CONNECT RV", 13 Send "DISCONNECT RV", 14 FORWARD, 15 BACKWARD, 16 LEFT, 17 RIGHT, 18 STOP, 19 RESUME, 20 STAY, 21 TO XY, 22 TO POLAR, 23 A TO ANGLE.

- Drive RV...

- Send("RV")
 - FORWARD
 - BACKWARD
 - LEFT
 - RIGHT
 - STOP
 - RESUME
 - STAY
 - TO XY
 - TO POLAR
 - TO ANGLE

CE Calculators



TI-Nspire™ CX

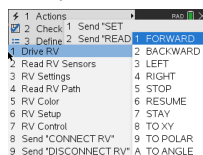

- Read RV Sensors...

- Send"READ"
 - RV.RANGER
 - RV.COLORINPUT
 - RV.COLORINPUT.RED
 - RV.COLORINPUT.GREEN
 - RV.COLORINPUT.BLUE
 - RV.COLORINPUT.GRAY

CE Calculators

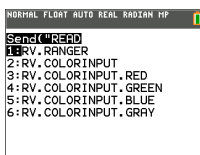

TI-Nspire™ CX

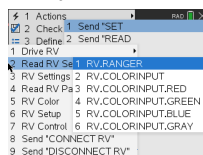

- RV Settings...

- RV Settings
 - SPEED
 - TIME
 - DISTANCE
 - UNIT/S
 - M/S
 - REV/S
 - UNITS
 - M
 - REVS
 - DEGREES
 - RADIANS

CE Calculators

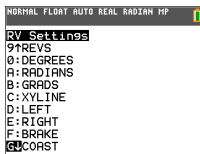
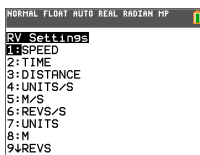

TI-Nspire™ CX

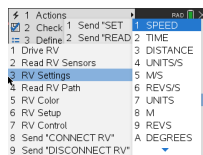

- GRADS
- XYLINE
- LEFT
- RIGHT
- BRAKE
- COAST
- CW
- CCW

- **Read RV Path...**

- Send "READ"
 - RV.WAYPOINT.XYTHDRN
 - RV.WAYPOINT.PREV
 - RV.WAYPOINT.CMDNUM
 - RV.PATHLIST.X
 - RV.PATHLIST.Y
 - RV.PATHLIST.TIME
 - RV.PATHLIST.HEADING
 - RV.PATHLIST.DISTANCE
 - RV.PATHLIST.REVS
 - RV.PATHLIST.CMDNUM
 - RV.WAYPOINT.X
 - RV.WAYPOINT.Y
 - RV.WAYPOINT.TIME
 - RV.WAYPOINT.HEADING
 - RV.WAYPOINT.DISTANCE
 - RV.WAYPOINT.REVS

CE Calculators

```
NORMAL FLOAT AUTO REAL RADIAN MP
Send("READ")
1:RV.WAYPOINT.XYTHDRN
2:RV.WAYPOINT.PREV
3:RV.WAYPOINT.CMDNUM
4:RV.PATHLIST.X
5:RV.PATHLIST.Y
6:RV.PATHLIST.TIME
7:RV.PATHLIST.HEADING
8:RV.PATHLIST.DISTANCE
9:RV.PATHLIST.REVS
```

```
NORMAL FLOAT AUTO REAL RADIAN MP
Send("READ")
8:RV.PATHLIST.DISTANCE
9:RV.PATHLIST.REVS
0:RV.PATHLIST.CMDNUM
9:RV.WAYPOINT.X
8:RV.WAYPOINT.Y
C:RV.WAYPOINT.TIME
D:RV.WAYPOINT.HEADING
E:RV.WAYPOINT.DISTANCE
9:RV.WAYPOINT.REVS
```

TI-Nspire™ CX

```
1 Actions
2 Check 1 RV.WAYPOINT.XYTHDRN
3 Define 2 RV.WAYPOINT.PREV
1 Drive RV 3 RV.WAYPOINT.CMDNUM
2 Read RV Set 4 RV.PATHLIST.X
3 RV Settings 5 RV.PATHLIST.Y
4 Read RV Path 6 RV.PATHLIST.TIME
5 RV Color 7 RV.PATHLIST.HEADING
6 RV Setup 8 RV.PATHLIST.DISTANCE
7 RV Control 9 RV.PATHLIST.REVS
8 Send 'CONNA RV.PATHLIST.CMDNUM
9 Send 'DISC
```

- **RV Color...**

- Send "SET"
 - RV.COLOR
 - RV.COLOR.RED
 - RV.COLOR.GREEN
 - RV.COLOR.BLUE

CE Calculators

```
NORMAL FLOAT AUTO REAL RADIAN MP
Send("SET")
1:RV.COLOR
2:RV.COLOR.RED
3:RV.COLOR.GREEN
4:RV.COLOR.BLUE
```

TI-Nspire™ CX

```
1 Actions
2 Check 1 Send 'SET
3 Define 2 Send 'READ
1 Drive RV
2 Read RV Sensors
3 RV Settings
4 Read RV Path
5 RV Color 1 RV.COLOR
6 RV Setup 2 RV.COLOR.RED
7 RV Control 3 RV.COLOR.GREEN
8 Send 'CONNECT 4 RV.COLOR.BLUE
9 Send 'DISCONNECT RV"
```

- **RV Setup...**

- Send "SET"
 - RV.POSITION
 - RV.GYRO
 - RV.GRID.ORIGIN
 - RV.GRID.M/UNIT
 - RV.PATH CLEAR
 - RV MARK

CE Calculators

```
NORMAL FLOAT AUTO REAL RADIAN MP
Send("SET")
1:RV.POSITION
2:RV.GYRO
3:RV.GRID.ORIGIN
4:RV.GRID.M/UNIT
5:RV.PATH CLEAR
6:RV MARK
```

TI-Nspire™ CX

```
1 Actions
2 Check 1 Send "SET"
3 Define 2 Send "READ"
1 Drive RV
2 Read RV Sensors
3 RV Settings
4 Read RV Path
5 RV Color
6 RV Setup
7 RV Control
8 Send "CONNECT RV"
9 Send "DISCONNECT RV"
```

- **RV Control...**

- Send ""
 - SET RV.MOTORS
 - SET RV.MOTOR.L
 - SET RV.MOTOR.R
 - SET RV.ENCODERSGYRO 0
 - READ RV.ENCODERSGYRO
 - READ RV.GYRO
 - READ RV.DONE
 - READ RV.ETA

CE Calculators

```
NORMAL FLOAT AUTO REAL RADIAN MP
Send("")
1:SET RV.MOTORS
2:SET RV.MOTOR.L
3:SET RV.MOTOR.R
4:SET RV.ENCODERSGYRO 0
5:READ RV.ENCODERSGYRO
6:READ RV.GYRO
7:READ RV.DONE
8:READ RV.ETA
```

TI-Nspire™ CX

```
1 Actions
2 Check 1 Send "SET"
3 Define 2 Send "READ"
1 Drive RV
2 Read RV 1 SET RV.MOTORS
3 RV Setup 2 SET RV.MOTOR.L
4 Read RV 3 SET RV.MOTOR.R
5 RV Color 4 SET RV.ENCODERSGYRO 0
6 RV Setup 5 READ RV.ENCODERSGYRO
7 RV Control 6 READ RV.GYRO
8 Send "CT" READ RV.DONE
9 Send "DI" 8 READ RV.ETA
```

- **Send "CONNECT RV"**

- Send "CONNECT RV"
 - CONNECT RV

CE Calculators

```
NORMAL FLOAT AUTO REAL RADIAN MP
Rowsep (RV)
1:Drive RV
2:Read RV Sensors...
3:RV Settings...
4:Read RV Path...
5:RV Color...
6:RV Setup...
7:RV Control...
8:Send("CONNECT RV")
9:Send("DISCONNECT RV")
PROGRAM:P
:Send("CONNECT RV")
```

TI-Nspire™ CX

```
1 Actions
2 Check 1 Send "SET"
3 Define 2 Send "READ"
1 Drive RV
2 Read RV Sensors
3 RV Settings
4 Read RV Path
5 RV Color
6 RV Setup
7 RV Control
8 Send "CONNECT RV"
9 Send "DISCONNECT RV"
```

- **Send "DISCONNECT RV"**

- Send "DISCONNECT RV"
 - DISCONNECT RV

CE Calculators

```
NORMAL FLOAT AUTO REAL RADIAN MP
Rowsep (RV)
1:Drive RV
2:Read RV Sensors...
3:RV Settings...
4:Read RV Path...
5:RV Color...
6:RV Setup...
7:RV Control...
8:Send("CONNECT RV")
9:Send("DISCONNECT RV")
```

TI-Nspire™ CX

```
1 Actions
2 Check 1 Send "SET"
3 Define 2 Send "READ"
1 Drive RV
2 Read RV Sensors
3 RV Settings
4 Read RV Path
5 RV Color
6 RV Setup
7 RV Control
8 Send "CONNECT RV"
9 Send "DISCONNECT RV"
```

```
NORMAL FLOAT AUTO REAL RADIAN MP
2015 08:00:15.000: P
PROGRAM: P
:Send("DISCONNECT RV")
```

Drive RV...

RV Drive Command Families

- Base Drive Commands (in the spirit of Turtle Graphics)
 - FORWARD, BACKWARD, RIGHT, LEFT, STOP, STAY
- Math Coordinate Drive Commands
 - Turn to Angle

Note: Drive commands have options for Speed, Time and Distance as appropriate

- See RV Settings for Machine-Level Control Commands
 - Set Left and Right Motor values for direction (CW/CCW) and level (0-255,Coast)
 - Read accumulated values for wheel encoder edges and gyro heading change.

• Drive RV...

- Send("RV
 - FORWARD
 - BACKWARD
 - LEFT
 - RIGHT
 - STOP
 - RESUME
 - STAY
 - TO XY
 - TO POLAR
 - TO ANGLE

CE Calculators

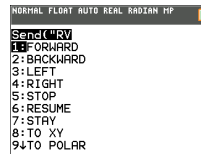

TI-Nspire™ CX

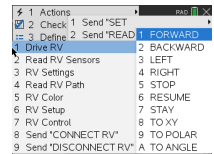

RV FORWARD

Command:	RV FORWARD
Command Syntax:	RV FORWARD [[SPEED s] [DISTANCE d] [TIME t]]
Code Samples:	<pre>Send ("RV FORWARD 0.5 M") Send ("RV FORWARD SPEED 0.22 M/S TIME 10")</pre> <hr/> <pre>[SET] RV FORWARD [SET] RV FORWARD [DISTANCE] d [M UNIT REV] [SET] RV FORWARD [DISTANCE] d [M UNIT REV] SPEED s.ss [M/S [UNIT/S] REV/S] [SET] RV FORWARD [DISTANCE] d [M UNIT REV] TIME t [SET] RV FORWARD SPEED s [M/S UNIT/S REV/S] [TIME t] [SET] RV FORWARD TIME t [SPEED s.ss [M/S [UNIT/S] REV/S]]</pre>
Range:	N/A
Describe:	<p>RV moves forward a given distance (default 0.75 m). Default distance if specified is in UNIT (grid units). Optional M=meters, UNIT=grid-unit, REV=wheel-revolution.</p> <p>Default speed is 0.20 m/sec, max is 0.23 m/sec, min is 0.14 m/sec. Speed may be given and specified in meters/second, unit/second, revolutions/second.</p>
Result:	Action to make the RV move in a forward direction
Type or Addressable Component:	<p>Control</p> <p>Note: This Rover control command is sent and executed in a queue.</p>

RV BACKWARD

Command:	RV BACKWARD
Command Syntax:	RV BACKWARD
Code Sample:	<pre>Send("RV BACKWARD 0.5 M") Send("RV BACKWARD SPEED 0.22 M/S TIME 10")</pre> <hr/> <pre>[SET] RV BACKWARD [SET] RV BACKWARD [DISTANCE] d [M UNIT REV] [SET] RV BACKWARD [DISTANCE] d [M UNIT REV] SPEED s.ss [M/S UNIT/S REV/S] [SET] RV BACKWARD [DISTANCE] d [M UNIT REV] TIME t [SET] RV BACKWARD SPEED s.ss [M/S UNIT/S REV/S] [TIME t] [SET] RV BACKWARD TIME t [SPEED s.ss [M/S UNIT/S REV/S]]</pre>
Range:	N/A
Describe:	<p>RV moves backward a given distance (default 0.75 m). Default distance if specified is in UNIT (grid units). Optional M=meters, UNIT=grid-unit, REV=wheel-revolution.</p> <p>Default speed is 0.20 m/sec, max is 0.23 m/sec, min is 0.14 m/sec. Speed may be given and specified in meters/second, unit/second, revolutions/second.</p>
Result:	Action to make the RV move in a backward direction.
Type or Addressable Component:	<p>Control</p> <p>Note: This Rover control command is sent and executed in a queue.</p>

RV LEFT

Command:	RV LEFT
Command Syntax:	RV LEFT
Code Sample:	Send "RV LEFT" [SET] RV LEFT [ddd [DEGREES]] [SET] RV LEFT [rrr RADIANS] [SET] RV LEFT [ggg GRADIANS]
Range:	N/A
Describe:	Default turn is 90 degrees unless DEGREES, RADIANS, or GRADIANS keyword is present, and then the value is converted internally to degrees format from the specified units. Value given is ranged to a value between 0.0 and 360.0 degrees. The turn will be executed as a SPIN motion.
Result:	Turn Rover to the LEFT.
Type or Addressable Component:	Control Note: This Rover control command is sent and executed in a queue.

RV RIGHT

Command:	RV RIGHT
Command Syntax:	RV RIGHT
Code Sample:	Send "RV RIGHT" [SET] RV RIGHT [ddd [DEGREES]] [SET] RV RIGHT [rrr RADIANS] [SET] RV RIGHT [ggg GRADIANS]
Range:	N/A
Describe:	Default turn is 90 degrees unless DEGREES, RADIANS, or GRADIANS keyword is present, and then the value is converted internally to degrees format from the specified units. Value given is ranged to a value between 0.0 and 360.0 degrees. The turn will be executed as a SPIN motion.

Command:	RV RIGHT
Result:	Turn Rover to the RIGHT.
Type or Addressable Component:	Control Note: This Rover control command is sent and executed in a queue.

RV STOP

Command:	RV STOP
Command Syntax:	RV STOP
Code Sample:	Send "RV STOP" [SET] RV STOP [SET] RV STOP CLEAR
Range:	N/A
Describe:	The RV will stop any current movement immediately. That movement can be resumed from where it left off with a RESUME operation. Any movement commands will cause the queue to flush immediately, and begin the just-posted new movement operation
Result:	Stop processing Rover commands from the command queue, and leave pending operations in the queue. (immediate action). Queue can be resumed by RESUME . The RV will stop any current movement immediately. That movement can be resumed from where it left off with a RESUME operation. Any movement commands will cause the queue to flush immediately, and begin the just-posted new movement operation. Stop processing Rover commands from the command queue, and flush any pending operations left in the queue. (immediate action).
Type or Addressable Component:	Control Note: This Rover control command is executed immediately.

RV RESUME

Command:	RV RESUME
Command Syntax:	RV RESUME
Code Sample:	Send "RV RESUME" [SET] RV RESUME
Range:	N/A
Describe:	Enable processing of Rover commands from the command queue. (immediate action), or resume (see RV STAY) operation.
Result:	Resume operation.
Type or Addressable Component:	Control Note: This Rover control command is sent and executed in a queue.

RV STAY

Command:	RV STAY
Command Syntax:	RV STAY
Code Sample:	Send "RV STAY" [SET] RV STAY [[TIME] s.ss]
Range:	N/A
Describe:	Tells RV to "stay" in place for an optionally specified amount of time in seconds. Default is 30.0 seconds.
Result:	RV stays in position.
Type or Addressable Component:	Control Note: This Rover control command is sent and executed in a queue.

RV TO XY

Command:	RV TO XY
Command Syntax:	RV TO XY x-coordinate y-coordinate [[SPEED] s.ss [UNIT/S] M/S REV/S] [XYLINE]
Code Sample:	Send "RV TO XY 1 1" Send "RV TO XY eval(X) eval(Y)" Send "RV TO XY 2 2 SPEED 0.23 M/S"
Range:	-327 to +327 for X and Y coordinates
Describe:	This command controls the movement of Rover on a virtual grid. Default location at start of program execution is (0,0) with Rover facing the positive x-axis. The x and y coordinates match the current grid size (default: 0.1 M/grid unit). Grid size can be changed through "SET RV.GRID.M/UNIT" command The speed parameter is optional.
Result:	Moves Rover from current grid location to the specified grid location.
Type or Addressable Component:	Control Note: This Rover control command is sent and executed in a queue.

RV TO POLAR

Command:	RV TO POLAR
Command Syntax:	RV TO POLAR R-coordinate Theta-coordinate [[DEGREES] RADIANS GRADS] [[SPEED] s.ss [UNIT/S] M/S REV/S] [XYLINE]
Code Sample:	Send ("RV TO POLAR 5 30") - r = 5 units, theta = 30 degrees Send ("RV TO POLAR 5 2 RADIANS") Send ("RV TO POLAR eval(sqrt(3^2+4^2)) eval(tan-1(4/3) DEGREES ")
Range:	Theta-coordinate: -360 to +360 degrees R-coordinate: -327 to +327
Describe:	Moves the RV from its current position to the specified polar position relative to that position. The RV's X/Y position will be updated to reflect the new position.

Command:	RV TO POLAR
	<p>The "r" coordinate matches the current grid size (default: 0.1 M/grid unit).</p> <p>Default location at start of program execution is (0,0) with Rover facing the positive x-axis.</p> <p>Default unit of theta is Degrees.</p> <p>The speed parameter is optional.</p>
Result:	Moves Rover from current grid location to the specified grid location.
Type or Addressable Component:	<p>Control</p> <p>Note: This Rover control command is sent and executed in a queue.</p>

RV TO ANGLE

Command:	RV TO ANGLE
Command Syntax:	RV TO ANGLE
Code Sample:	<p>Send "RV TO ANGLE"</p> <pre>[SET] RV TO ANGLE rr.rr [[DEGREES] RADIANS GRADIANS]</pre>
Range:	N/A
Describe:	
Result:	Spins the RV to the specified angle from current heading.
Type or Addressable Component:	<p>Control</p> <p>Note: This Rover control command is sent and executed in a queue.</p>

READ RV Sensors...

SEND("Read Sensor Commands

- Reading of low level sensors for learning foundations of robotics.

- **Read RV Sensors...**

- Send("READ
 - RV.RANGER
 - RV.COLORINPUT
 - RV.COLORINPUT.RED
 - RV.COLORINPUT.GREEN
 - RV.COLORINPUT.BLUE
 - RV.COLORINPUT.GRAY

CE Calculators

```

NORMAL FLOAT AUTO REAL RADIAN MP
Send("READ
1:RV.RANGER
2:RV.COLORINPUT
3:RV.COLORINPUT.RED
4:RV.COLORINPUT.GREEN
5:RV.COLORINPUT.BLUE
6:RV.COLORINPUT.GRAY
  
```

TI-Nspire™ CX

```

1 Actions
2 Check 1 Send "SET
3 Define 2 Send "READ
4 Drive RV
5 Read RV/S 1 RV.RANGER
6 RV Settings 2 RV.COLORINPUT
4 Read RV Pa 3 RV.COLORINPUT.GREEN
5 RV Color 4 RV.COLORINPUT.BLUE
6 RV Setup 5 RV.COLORINPUT.GRAY
7 RV Control 6 RV.COLORINPUT.GRAY
8 Send "CONNECT RV"
9 Send "DISCONNECT RV"
  
```

- **RV.RANGER:** Returns value in Meters.
- **RV.COLORINPUT:** Reads color sensor that is built into the RV.

RV.RANGER

Command:	RV.RANGER	
Command Syntax:	RV.RANGER	
Code Sample:	Send ("READ RV.RANGER") Get (R)	
	Connects the Rover Vehicle to the TI-Innovator™ Hub. This establishes connections with the motor driver, color sensor, gyroscope, ultrasonic ranger, and proximity sensors.	CONNECT RV
	Returns the current distance from the front of the RV to an obstacle. If there is no obstacle detected, a range of 10.00 meters is reported	READ RV.RANGER Get (R)

Command:	RV.RANGER
Range:	N/A
Describe:	The front-facing ultrasonic distance sensor. Returns measurements in meters. ~10.00 meters means no obstacle was detected.
Result:	Returns value in Meters.
Type or Addressable Component:	Sensor Note: This Rover sensor command is executed immediately.

READ RV.RANGER TIME

Command:	READ RV.RANGER TIME
Command Syntax:	READ RV.RANGER TIME
Range:	
Describe:	Additional functionality for RV.RANGER - to return time of flight instead of distance. The value is in seconds. And it is the round trip time for the signal.
Result:	Retrieves the time-of-flight data readings for the RANGER on TI-Innovator™ Rover.
Type or Addressable Component:	Sensor

RV.COLORINPUT

Command:	RV.COLORINPUT
Command Syntax:	RV.COLORINPUT
Code Sample:	Send ("READ RV.COLORINPUT") Get (C)

Command:	RV.COLORINPUT																				
Range:	1 thru 9																				
Describe:	Bottom-mounted color sensor detects the color of the surface. Can also detect gray-level scale of black (0) to white (255).																				
Result:	<p>Returns current color sensor information.</p> <p>The return value is in the 1–9 range which maps to the colors below:</p> <table border="1"> <thead> <tr> <th>Color</th> <th>Return value</th> </tr> </thead> <tbody> <tr> <td>Red</td> <td>1</td> </tr> <tr> <td>Green</td> <td>2</td> </tr> <tr> <td>Blue</td> <td>3</td> </tr> <tr> <td>Cyan</td> <td>4</td> </tr> <tr> <td>Magenta</td> <td>5</td> </tr> <tr> <td>Yellow</td> <td>6</td> </tr> <tr> <td>Black</td> <td>7</td> </tr> <tr> <td>White</td> <td>8</td> </tr> <tr> <td>Gray</td> <td>9</td> </tr> </tbody> </table>	Color	Return value	Red	1	Green	2	Blue	3	Cyan	4	Magenta	5	Yellow	6	Black	7	White	8	Gray	9
Color	Return value																				
Red	1																				
Green	2																				
Blue	3																				
Cyan	4																				
Magenta	5																				
Yellow	6																				
Black	7																				
White	8																				
Gray	9																				
Type or Addressable Component:	<p>Sensor</p> <p>Note: This Rover sensor command is executed immediately.</p>																				

RV.COLORINPUT.RED

Command:	RV.COLORINPUT.RED
Command Syntax:	RV.COLORINPUT.RED
Code Sample:	<pre>Send ("READ RV.COLORINPUT.RED") Get (R)</pre>
Range:	0 - 255
Describe:	<p>Detect intensity of individual red components of surface.</p> <p>The results are in 0-255 range.</p>
Result:	Returns current color sensor "red value".
Type or Addressable Component:	<p>Sensor</p> <p>Note: This Rover sensor command is executed immediately.</p>

RV.COLORINPUT.GREEN

Command:	RV.COLORINPUT.GREEN
Command Syntax:	RV.COLORINPUT.GREEN
Code Sample:	Send ("READ RV.COLORINPUT.GREEN") Get (G)
Range:	0 - 255
Describe:	Detect intensity of individual green components of surface. The results are in 0-255 range.
Result:	Returns current color sensor "green" value.
Type or Addressable Component:	Sensor Note: This Rover sensor command is executed immediately.

RV.COLORINPUT.BLUE

Command:	RV.COLORINPUT.BLUE
Command Syntax:	RV.COLORINPUT.BLUE
Code Sample:	Send ("READ RV.COLORINPUT.BLUE") Get (B)
Range:	0 - 255
Describe:	Detect intensity of individual blue components of surface. The results are in 0-255 range.
Result:	Returns current color sensor "blue" value.
Type or Addressable Component:	Sensor Note: This Rover sensor command is executed immediately.

RV.COLORINPUT.GRAY

Command:	RV.COLORINPUT.GRAY
Command Syntax:	RV.COLORINPUT.GRAY
Code Sample:	Send ("READ RV.COLORINPUT.GRAY") Get (G)
Range:	0 - 255
Describe:	Detect grayness of surface. The result will be in 0-255 range.
Result:	Returns an interpolated "grayscale" value based on $0.3*\text{red} + 0.59*\text{green} + 0.11*\text{blue}$ 0-black, 255 - white.
Type or Addressable Component:	Sensor Note: This Rover sensor command is executed immediately.

RV Settings...

RV Settings Commands

Settings menu for Rover contains other commands that support RV commands such as FORWARD or BACKWARD.

- **RV Settings...**

- RV Settings
 - SPEED
 - TIME
 - DISTANCE
 - UNIT/S
 - M/S
 - REV/S
 - UNITS
 - M
 - REVS
 - DEGREES
 - RADIANS
 - GRADS
 - XYLINE
 - LEFT
 - RIGHT
 - BRAKE
 - COAST
 - CW
 - CCW

CE Calculators

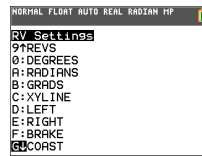
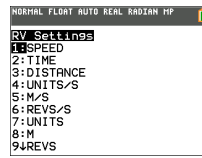

TI-Nspire™ CX

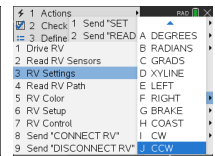
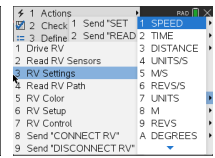

Read RV Path...

Reading WAYPOINT and PATH

Tracking the RV's Path

In order to support analysis of the Rover during and after a run, the sketch will automatically measure the following information for each Drive command:

- X Coordinate on virtual grid
- Y Coordinate on virtual grid
- Time in seconds that the current command has been executing.
- Distance in coordinate units for the path segment.
- Heading in degrees (absolute terms measured Counter Clockwise with the X-axis as 0 degrees.
- Revolutions by the wheel in executing the current command
- Command number, tracks the number of commands executed, begins with 0.

The Path values will be stored in lists, starting with the segments associated with the earliest commands and going to the segments associated with the latest commands.

The drive command in progress, the **WAYPOINT**, will repeatedly update the last element in the Path lists as the Rover progresses toward the last waypoint.

When a drive command is completed a new waypoint is initiated and the dimension of the Path lists are incremented.

Note: This implies that when all the drive commands in the queue are completed that another waypoint for the stopped state is automatically started. This is similar to the initial position where the RV is stationary and counting time.

Max number of waypoints: 80

RV Position and Path

- Ability to read X,Y coordinate, Heading, Time and Distance for each drive command in execution.
- Will store path history in lists for plotting and analysis

Note: Coordinate grid scale can be set by the user, default is 10cm per unit. The user will have options to set the origin of the grid.

- **Read RV Path...**

- Send("READ")
 - RV.WAYPOINT.XYTHDRN
 - RV.WAYPOINT.PREV
 - RV.WAYPOINT.CMDNUM
 - RV.PATHLIST.X
 - RV.PATHLIST.Y
 - RV.PATHLIST.TIME
 - RV.PATHLIST.HEADING
 - RV.PATHLIST.DISTANCE
 - RV.PATHLIST.REVS
 - RV.PATHLIST.CMDNUM
 - RV.WAYPOINT.X
 - RV.WAYPOINT.Y
 - RV.WAYPOINT.TIME
 - RV.WAYPOINT.HEADING
 - RV.WAYPOINT.DISTANCE
 - RV.WAYPOINT.REVS

CE Calculators

```

NORMAL FLOAT AUTO REAL RADIAN MP
Send("READ")
1:RV.WAYPOINT.XYTHDRN
2:RV.WAYPOINT.PREV
3:RV.WAYPOINT.CMDNUM
4:RV.PATHLIST.X
5:RV.PATHLIST.Y
6:RV.PATHLIST.TIME
7:RV.PATHLIST.HEADING
8:RV.PATHLIST.DISTANCE
9:RV.PATHLIST.REVS
  
```

TI-Nspire™ CX

```

1 Actions
2 Check 1 RV.WAYPOINT.XYTHDRN
3 Define 2 RV.WAYPOINT.PREV
1 Drive RV 3 RV.WAYPOINT.CMDNUM
3 RV Settings 5 RV.PATHLIST.X
4 Read RV P 6 RV.PATHLIST.TIME
5 RV Color 7 RV.PATHLIST.HEADING
6 RV Setup 8 RV.PATHLIST.DISTANCE
7 RV Control 9 RV.PATHLIST.REVS
8 Send "CON A RV.PATHLIST.CMDNUM
9 Send "DISC
  
```

See Also:

- RV.ETA
- RV.DONE

RV.WAYPOINT.XYTHDRN

Command:	RV.WAYPOINT.XYTHDRN
Command Syntax:	RV.WAYPOINT.XYTHDRN
Code Sample:	<code>Send ("READ RV.WAYPOINT.XYTHDRN")</code>
Example:	Getting the distance traveled toward the current way-point from the last way-point
Code Sample:	<code>Send ("READ RV.WAYPOINT.XYTHDRN") Get (L1) (L1) (5) ->D</code>
Range:	N/A
Describe:	READ RV.WAYPOINT.XYTHDRN - read the x-coord, y-coord, time, heading, distance traveled, number of wheel revolutions, command number of the current waypoint. Returns a list with all these values as elements.
Result:	Return list of current way-point X, Y coordinates, Time, Heading, Distance, Revolutions, and command number.
Type or Addressable Component:	Returns Data

RV.WAYPOINT.PREV

Command:	RV.WAYPOINT.PREV
Command Syntax:	RV.WAYPOINT.PREV
Code Sample:	<code>Send ("READ RV.WAYPOINT.PREV")</code>
Example:	Getting the distance traveled during the previous way-point.
Code Sample:	<code>Send ("READ RV.WAYPOINT.PREV") Get (L1) (L1) (5) ->D</code>

Command:	RV.WAYPOINT.PREV
Range:	N/A
Describe:	READ RV.WAYPOINT.PREV - read the x-coord, y-coord, time, heading, distance traveled, number of wheel revolutions, command number of the previous waypoint. Returns a list with all these values as elements.
Result:	Return list of the previous way-point X, Y coordinates, time, heading, distance, revolutions, and command number.
Type or Addressable Component:	Returns Data

RV.WAYPOINT.CMDNUM

Command:	RV.WAYPOINT.CMDNUM
Command Syntax:	RV.WAYPOINT.CMDNUM
Code Sample:	Send ("READ RV.WAYPOINT.CMDNUM")
Example:	<p>Program to determine if a drive command has completed without referring to a specific command number.</p> <p>Note: the Wait is intended to increase the probability of catching a difference in the Command Number.</p>
Code Sample:	<pre>Send("RV FORWARD 10") Send("READ RV.WAYPOINT.CMDNUM") Get (M) M->N While M=N Send("READ RV.WAYPOINT.CMDNUM") Get (N) End Disp "Drive Command is completed"</pre>
Range:	N/A

Command:	RV.WAYPOINT.CMDNUM
Describe:	READ RV.WAYPOINT.CMDNUM - returns the last command number of the current waypoint.
Result:	Returns a value of 0 if the RV is currently "working" on a command and is either in motion, or running a STAY operation. This command will return a value of 1 when ALL queued operations are completed, nothing is remaining in the command queue, and the current operation has completed (and immediately after CONNECT RV).
Type or Addressable Component:	Returns Data

See Also: RV.DONE

RV.PATHLIST.X

Command:	RV.PATHLIST.X
Command Syntax:	RV.PATHLIST.X
Code Samples:	<code>Send("READ RV.PATHLIST.X")</code>
Example:	Program to plot the RV path on the graph screen
Code Samples:	<pre>Plot1(xyLine, L1, L2, □, BLUE) Send("READ RV.PATHLIST.X") Get(L1) Send("READ RV.PATHLIST.Y") Get(L2) DispGraph</pre>
Range:	N/A
Describe:	READ RV.PATHLIST.X - returns a list of X values from the beginning to and including the current Waypoint X value.
Result:	Return list of X coordinates traversed since last RV.PATH CLEAR or initial CONNECT RV .

Command:	RV.PATHLIST.X
Type or Addressable Component:	Returns Data

RV.PATHLIST.Y

Command:	RV.PATHLIST.Y
Command Syntax:	RV.PATHLIST.Y
Code Sample:	Send ("READ RV.PATHLIST.Y")
Example:	Program to plot the RV path on the graph screen
Code Sample:	<pre>Plot1(xyLine, L1, L2, □, BLUE) Send("READ RV.PATHLIST.Y") Get(L1) Send("READ RV.PATHLIST.X") Get(L2) DispGraph</pre>
Range:	N/A
Describe:	READ RV.PATHLIST.Y - returns a list of Y values from the beginning to and including the current Waypoint Y value.
Result:	Return list of Y coordinates traversed since last RV.PATH CLEAR or initial CONNECT RV .
Type or Addressable Component:	Returns Data

RV.PATHLIST.TIME

Command:	RV.PATHLIST.TIME
Command Syntax:	RV.PATHLIST.TIME
Code	Send "READ RV.PATHLIST.TIME"

Command:	RV.PATHLIST.TIME
Sample:	
Range:	N/A
Describe:	READ RV.PATHLIST.TIME - returns a list of the time in seconds from the beginning to and including the current Waypoint time value.
Result:	Return list of cumulative travel times for each successive way-point.
Type or Addressable Component:	Returns Data

RV.PATHLIST.HEADING

Command:	RV.PATHLIST.HEADING
Command Syntax:	RV.PATHLIST.HEADING
Code Sample:	Send "READ RV.PATHLIST.HEADING"
Range:	N/A
Describe:	READ RV.PATHLIST.HEADING - returns a list of the headings from the beginning to and including the current Waypoint heading value.
Result:	Return list of cumulative angular headings taken.
Type or Addressable Component:	Returns Data

RV.PATHLIST.DISTANCE

Command:	RV.PATHLIST.DISTANCE
Command Syntax:	RV.PATHLIST.DISTANCE
Example:	Getting the cumulative distance traveled since the beginning of a journey by the RV
Code	Send "READ RV.PATHLIST.DISTANCE"

Command:	RV.PATHLIST.DISTANCE
Sample:	Get (L ₁) sum (L ₁)
Range:	N/A
Describe:	READ RV.PATHLIST.DISTANCE - returns a list of the distances traveled from the beginning to and including the current Waypoint distance value.
Result:	Return list of cumulative distances traveled.
Type or Addressable Component:	Returns Data

RV.PATHLIST.REVS

Command:	RV.PATHLIST.REVS
Command Syntax:	RV.PATHLIST.REVS
Code Sample:	Send "READ RV.PATHLIST.REVS"
Range:	N/A
Describe:	READ RV.PATHLIST.REVS - returns a list of the number of revolutions traveled from the beginning to and including the current Waypoint revolutions value.
Result:	Return list of wheel revolutions traveled.
Type or Addressable Component:	Returns Data

RV.PATHLIST.CMDNUM

Command:	RV.PATHLIST.CMDNUM
Command Syntax:	RV.PATHLIST.CMDNUM

Command:	RV.PATHLIST.CMDNUM
Code Sample:	Send "READ RV.PATHLIST.CMDNUM"
Range:	N/A
Describe:	READ RV.PATHLIST.CMDNUM - returns a list of command numbers for the path
Result:	<p>Return list of commands used to travel to the current way-point entry.</p> <p>0 - Start of Way-points (if first action is a STAY, then no START is given, but a STAY will be shown instead.)</p> <p>1 - Travel forward</p> <p>2 - Travel backward</p> <p>3 - Left spin motion</p> <p>4 - Right spin motion</p> <p>5 - Left turn motion</p> <p>6 - Right turn motion</p> <p>7 - Stay (no motion) the time the RV stays at the current position is given in the TIME list.</p> <p>8 - RV is currently in motion on this way-point traversal.</p>
Type or Addressable Component:	Returns Data

RV.WAYPOINT.X

Command:	RV.WAYPOINT.X
Command Syntax:	RV.WAYPOINT.X
Code Samples:	Send ("READ RV.WAYPOINT.X")
Range:	N/A
Describe:	READ RV.WAYPOINT.X - returns x coordinate of current waypoint.
Result:	Return current way-point X coordinate.
Type or Addressable Component:	Returns Data

Command:	RV.WAYPOINT.X
Component:	

RV.WAYPOINT.Y

Command:	RV.WAYPOINT.Y
Command Syntax:	RV.WAYPOINT.Y
Code Samples:	<code>Send("READ RV.WAYPOINT.Y")</code>
Range:	N/A
Describe:	READ RV.WAYPOINT.Y - returns x coordinate of current waypoint.
Result:	Return current way-point Y coordinate.
Type or Addressable Component:	Returns Data

RV.WAYPOINT.TIME

Command:	RV.WAYPOINT.TIME
Command Syntax:	RV.WAYPOINT.TIME
Code Sample:	<code>Send("READ RV.WAYPOINT.TIME")</code>
Range:	N/A
Describe:	READ RV.WAYPOINT.TIME - returns time spent traveling from previous to current waypoint
Result:	Return total cumulative way-point travel time value in seconds.
Type or Addressable Component:	Returns Data

RV.WAYPOINT.HEADING

Command:	RV.WAYPOINT.HEADING
Command Syntax:	RV.WAYPOINT.HEADING
Code Sample:	<code>Send("READ RV.WAYPOINT.HEADING")</code>
Range:	N/A
Describe:	READ RV.WAYPOINT.HEADING - returns absolute heading of current waypoint
Result:	Return current absolute heading in degrees. (+h = counter-clockwise, -h = clockwise.)
Type or Addressable Component:	Returns Data

RV.WAYPOINT.DISTANCE

Command:	RV.WAYPOINT.DISTANCE
Command Syntax:	RV.WAYPOINT.DISTANCE
Code Sample:	<code>Send("READ RV.WAYPOINT.DISTANCE")</code>
Range:	N/A
Describe:	READ RV.WAYPOINT.DISTANCE - returns distance traveled between previous and current waypoint
Result:	Return cumulative total distance traveled in meters.
Type or Addressable Component:	Returns Data

RV.WAYPOINT.REVS

Command:	RV.WAYPOINT.REVS
Command Syntax:	RV.WAYPOINT.REVS
Code Sample:	<code>Send("READ RV.WAYPOINT.REVS")</code>
Range:	N/A
Describe:	READ RV.WAYPOINT.REVS - returns number of revolutions needed to travel between previous and current waypoint
Result:	Return total revolutions of the wheels performed to travel the cumulative distance to the current way-point.
Type or Addressable Component:	Returns Data

RV Color...

Send("SET Commands

RGB LED on Rover - This supports the same commands and parameters as the RGB LED on the TI-Innovator™ Hub.

- **RV Color...**
 - Send("SET
 - RV.COLOR
 - RV.COLOR.RED
 - RV.COLOR.GREEN
 - RV.COLOR.BLUE

CE Calculators

```
NORMAL FLOAT AUTO REAL RADIAN MP
Send("SET
1:RV.COLOR
2:RV.COLOR.RED
3:RV.COLOR.GREEN
4:RV.COLOR.BLUE
```

TI-Nspire™ CX

```
1 Actions
2 Check Send/Set
3 Define 2 Send/READ
4 Drive RV
5 Read RV Sensors
6 RV Settings
7 Read RV Path
8 RV Color 1 RV.COLOR
9 RV Setup 2 RV.COLOR.RED
10 RV Control 3 RV.COLOR.GREEN
11 Send 'CONNECT' 4 RV.COLOR.BLUE
12 Send 'DISCONNECT RV'
```

RV.COLOR

Command:	RV.COLOR
Command Syntax:	RV.COLOR
Code Sample:	<pre>Send "SET RV.COLOR [SET] RV.COLOR rr gg bb [[BLINK] b [[TIME] s.ss]</pre>
Range:	N/A
Describe:	Set the RGB color to be displayed on the Rover's RGB LED. Same syntax as for all RGB LED operations with COLOR, etc.
Result:	Return the current RGB color, as a three-element list, that is being displayed on the Rover's RGB LED
Type or Addressable Component:	Control Note: This Rover control command is sent and executed in a queue.

RV.COLOR.RED

Command:	RV.COLOR.RED
Command Syntax:	RV.COLOR.RED
Code	<pre>Send "SET RV.COLOR.RED</pre>

Command:	RV.COLOR.RED
Sample:	[SET] RV.COLOR.RED rr [[BLINK] b [[TIME] s.ss]]
Range:	N/A
Describe:	
Result:	Set the RED color to be displayed on the Rover's RGB LED.
Type or Addressable Component:	Control Note: This Rover control command is sent and executed in a queue.

RV.COLOR.GREEN

Command:	RV.COLOR.GREEN
Command Syntax:	RV.COLOR.GREEN
Code Sample:	Send "SET RV.COLOR.GREEN [SET] RV.COLOR.GREEN gg [[BLINK] b [[TIME] s.ss]]
Range:	N/A
Describe:	
Result:	Set the GREEN color to be displayed on the Rover's RGB LED.
Type or Addressable Component:	Control Note: This Rover control command is sent and executed in a queue.

RV.COLOR.BLUE

Command:	RV.COLOR.BLUE
Command Syntax:	RV.COLOR.BLUE

Command:	RV.COLOR.BLUE
Code Sample:	<pre>Send "SET RV.COLOR.BLUE [SET] RV.COLOR.BLUE bb [[BLINK] b [[TIME] s.ss]</pre>
Range:	N/A
Describe:	
Result:	Set the BLUE color to be displayed on the Rover's RGB LED.
Type or Addressable Component:	Control Note: This Rover control command is sent and executed in a queue.

RV Setup...

Send("SET Commands

- RV Setup...

- Send("SET
 - RV.POSITION
 - RV.GYRO
 - RV.GRID.ORIGIN
 - RV.GRID.M/UNIT
 - RV.PATH CLEAR
 - RV MARK

CE Calculators



TI-Nspire™ CX

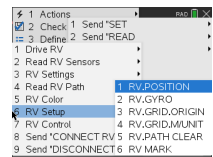

RV.POSITION

Command:	RV.POSITION
Command Syntax:	RV.POSITION
Code Sample:	<pre>Send "SET RV.POSITION" [SET] RV.POSITION xxx yyy [hhh [[DEGREES] RADIANS GRADIANS]]</pre>
Range:	N/A
Describe:	Sets the coordinate position and optionally the heading of the Rover on the virtual grid.
Result:	Rover configuration is updated.
Type or Addressable Component:	Setting

RV.GYRO

Command:	RV.GYRO
Command Syntax:	RV.GYRO
Code Sample:	<pre>Send "SET RV.GYRO"</pre>

Command:	RV.GYRO
Range:	N/A
Describe:	Sets the on-board Gyroscope.
Result:	
Type or Addressable Component:	Control (for Gyroscope)

RV.GRID.ORIGIN

Command:	RV.GRID.ORIGIN
Command Syntax:	RV.GRID.ORIGIN
Code Sample:	Send "SET RV.GRID.ORIGIN" [SET] RV.GRID.ORIGIN
Range:	N/A
Describe:	Sets RV as being at current grid origin point of (0,0). The "heading" is set to 0.0 resulting in the current position of the RV now set to pointing down a virtual x-axis toward positive x values.
Result:	
Type or Addressable Component:	Setting

RV.GRID.M/UNIT

Command:	RV.GRID.M/UNIT
Command Syntax:	RV.GRID.M/UNIT
Code Sample:	Send "SET RV.GRID.M/UNIT" [SET] RV.GRID.M/UNIT nnn

Command:	RV.GRID.M/UNIT
Range:	N/A
Describe:	Set the size of a "grid unit" on the virtual grid. Default is 10 units per meter (100 mm / 10 cm per unit grid). A value of 5 means 5 units per meter or 200 mm / 20 cm per unit grid). A value of 20 means 20 units per meter, or 50 mm / 5 cm per unit grid.
Result:	
Type or Addressable Component:	Setting

RV.PATH CLEAR

Command:	RV.PATH CLEAR
Command Syntax:	RV.PATH CLEAR
Code Sample:	Send "SET RV.PATH CLEAR" [SET] RV.PATH CLEAR
Range:	N/A
Describe:	Clears any pre-existing path / waypoint information. Recommended before doing a sequence of movement operations where waypoint / path-list information is desired.
Result:	
Type or Addressable Component:	Setting

RV MARK

Command:	RV MARK
Command Syntax:	RV MARK
Code Sample:	Send "SET RV MARK" [SET] RV MARK [[TIME] s.ss]

Command:	RV MARK
Range:	N/A
Describe:	<p>Enable RV to make a "mark" with a pen at the specified time interval (default is 1 second if not specified).</p> <p>A time value of 0.0 turns OFF marking.</p> <p>Marking ONLY happens if the Rover is moving in a forward direction.</p>
Result:	
Type or Addressable Component:	Setting (for Rover)

RV Control...

SEND(" Commands

Wheel commands and other commands relevant for learning foundations of the Rover vehicle.

- **RV Control ...**

- Send("

- SET RV.MOTORS
 - SET RV.MOTOR.L
 - SET RV.MOTOR.R
 - SET RV.ENCODERSGYRO 0
 - READ RV.ENCODERSGYRO
 - READ RV.GYRO
 - READ RV.DONE
 - READ RV.ETA

CE Calculators

```
NORMAL FLOAT AUTO REAL RADIAN MP
Send("
1:SET RV.MOTORS
2:SET RV.MOTOR.L
3:SET RV.MOTOR.R
4:SET RV.ENCODERSGYRO 0
5:READ RV.ENCODERSGYRO
6:READ RV.GYRO
7:READ RV.DONE
8:READ RV.ETA
```

TI-Nspire™ CX

```
1 Actions
2 Check 1 Send "SET
3 Define 2 Send "READ
4 Drive RV
5 Read RV 1 SET RV.MOTORS
6 RV Setup 2 SET RV.MOTOR.L
7 RV Setup 3 SET RV.MOTOR.R
8 RV Color 4 SET RV.ENCODERSGYRO 0
9 RV Setup 5 READ RV.ENCODERSGYRO
10 RV Color 6 READ RV.GYRO
11 Send "C7 READ RV.DONE
12 Send "DH 8 READ RV.ETA
```

SET RV.MOTORS

Command:	SET RV.MOTORS
Command Syntax:	SET RV.MOTORS
Code Sample:	<pre>Send "SET RV.MOTORS" [SET] RV.MOTORS [LEFT] [CW CCW] <pwm value BRAKE COAST> [RIGHT] [CW CCW] <pwm value BRAKE COAST> [DISTANCE ddd [M] [UNITS] REV FT]] [TIME s.ss]</pre>
Range:	N/A
Describe:	<p>Set left or right or both motor PWM values. Negative values imply CCW and Positive values imply CW. Left CW=backward motion. Left CCW=forward motion. Right CW=forward motion, Right CCW=backward motion. PWM values may be numeric from -255 to +255, or keywords "COAST" or "BRAKE". Value of 0 is stop (coast).</p> <p>Use of the DISTANCE option is only available if the RV is connected with all sensors. CONNECT RV MOTORS means no sensors are available to measure distance, so the DISTANCE option is an error in</p>

Command:	SET RV.MOTORS
	this instance.
Result:	Both the LEFT and RIGHT motor, managed as a single object for direct control (advanced) use.
Type or Addressable Component:	Control Note: This Rover control command is sent and executed in a queue.

SET RV.MOTOR.L

Command:	SET RV.MOTOR.L
Command Syntax:	SET RV.MOTOR.L
Code Sample:	Send "SET RV.MOTOR.L" [SET] RV.MOTOR.L [CW CCW] <+/-pwm value BRAKE COAST> [TIME s.ss] [DISTANCE ddd [[UNITS] M REV FT]]
Range:	N/A
Describe:	Set left motor direct PWM value. CCW = forward, CW = backward, pwm value negative = forward, positive = backward. TIME option available in all modes, DISTANCE option available only when RV is fully connected (not the RV MOTORS option).
Result:	Left wheel motor and control for direct control (advanced) use.
Type or Addressable Component:	Control Note: This Rover control command is sent and executed in a queue.

SET RV.MOTOR.R

Command:	SET RV.MOTOR.R
Command Syntax:	SET RV.MOTOR.R
Code Sample:	Send "SET RV.MOTOR.R" [SET] RV.MOTOR.R [CW CCW] <+/-pwm

Command:	SET RV.MOTOR.R
	value BRAKE COAST> [TIME s.ss] [DISTANCE ddd [[UNITS] M REV FT]]
Range:	N/A
Describe:	Set right motor direct PWM value. CW = forward, CCW = backward, pwm value positive = forward, negative = backward. TIME option available in all modes, DISTANCE option available only when RV is fully connected (not the RV MOTORS option).
Result:	Right wheel motor and control for direct control (advanced) use.
Type or Addressable Component:	Control Note: This Rover control command is sent and executed in a queue.

SET RV.ENCODERSGYRO 0

Command:	SET RV.ENCODERSGYRO 0
Command Syntax:	SET RV.ENCODERSGYRO 0
Code Sample:	Send "SET RV.ENCODERSGYRO 0"
Range:	N/A
Describe:	Reset the left and right encoder, coupled with the gyro and operating time information.
Result:	
Type or Addressable Component:	Control Note: This Rover control command is sent and executed in a queue.

READ RV.ENCODERSGYRO

Command:	READ RV.ENCODERSGYRO
Command Syntax:	READ RV.ENCODERSGYRO

Command:	READ RV.ENCODERSGYRO
Code Sample:	Send "READ RV.ENCODERSGYRO"
Range:	N/A
Describe:	The left and right encoder, coupled with the gyro and operating time information.
Result:	List of values of current left and right encoder, coupled with gyro and operating time information
Type or Addressable Component:	Control Note: This Rover READ command is executed immediately.

READ RV.GYRO

Command:	READ RV.GYRO
Command Syntax:	READ RV.GYRO
Code Sample:	Send "READ RV.GYRO" READ RV.GYRO [[DEGREES] RADIANS GRADIANS]
Range:	N/A
Describe:	The gyroscope is used to maintain the heading of Rover while it's in motion. It can also be used to measure the change in angle during turns. The gyroscope is ready to use after the CONNECT RV command is processed. The GYRO object shall be usable even when the RV is not in motion.
Result:	Returns current gyro sensor angular deviation from 0.0, reading partially drift-offset compensated.
Type or Addressable Component:	Control Note: This Rover READ command is executed immediately.

READ RV.DONE

Command:	READ RV.DONE
Command Syntax:	READ RV.DONE
Code Sample:	Send("READ RV.DONE")
Example:	RV.DONE as an alias for RV.WAYPOINT.CMDNUM
Code Sample:	<pre>For n,1,16 Send "RV FORWARD 0.1" Send "RV LEFT" EndFor @ Wait for Rover to finish driving Send "READ RV.DONE" Get d While d=0 Send "READ RV.DONE" Get d Wait 0.1 EndWhile Send "READ RV.PATHLIST" Get L</pre>
Range:	N/A
Describe:	RV.DONE as an alias for RV.WAYPOINT.CMDNUM To improve usability a new state variable was created called RV.DONE . This is an alias of RV.WAYPOINT.CMDNUM .
Result:	
Type or Addressable Component:	Returns Data

See Also: RV.WAYPOINT.CMDNUM

READ RV.ETA

Command:	READ RV.ETA
Command Syntax:	READ READ RV.ETA
Code Sample:	<pre>Send ("READ RV.ETA")</pre>
Example:	The code sample below returns the estimated time to drive to coordinate (4,4)
Code Sample:	<pre>Send "RV TO XY 4 4" Send "READ RV.ETA" Get eta Disp eta</pre>
	<p>Note: This value will not be exact. It will depend on the surface for one, but it will be a close enough estimate for the expected applications.</p> <p>The value will be time in seconds with a minimum unit of 100 ms.</p>
Example	If a different READ command is issued, the value of the variable is overwritten with the information that was requested.
Code Sample:	<pre>Send "RV TO XY 3 4" Send "READ BRIGHTNESS" Get eta</pre>
	<p>Note: eta - will contain the value of the BRIGHTNESS sensor, not the RV.ETA variable</p>
Range:	N/A
Describe:	Calculate the estimated time to complete each Rover command.
Result:	
Type or Addressable Component:	Returns Data

Sample program:

Set RGB to red while moving forward, green when turning.

Code Sample:	<pre>For n, 1, 4 Send "RV FORWARD" Send "READ RV.ETA" Get eta Send "SET COLOR 255 0 0" Wait eta Send "RV LEFT" Send "READ RV.ETA" Get eta Send "SET COLOR 0 255 0" Wait eta EndFor</pre>
---------------------	--

Send "CONNECT RV"

SEND("CONNECT RV") Commands

CONNECT RV - initializes the hardware connections.

- Connects RV and inputs and outputs built into the RV.
- Resets the Path and the Grid Origin.
- Sets the units per meter to default value.
- **Send("CONNECT RV")**

CE Calculators

```
NORMAL FLOAT AUTO REAL RADIAN MP
EDIT MENU: C:\Inho1\FP2
PROGRAM:P
:Send("CONNECT RV")
```

TI-Nspire™ CX

```
1 Actions
2 Check 1 Send *SET
3 Define 2 Send *READ
4 Drive RV
5 Read RV Sensors
6 RV Settings
7 Read RV Path
8 RV Color
9 RV Setup
10 RV Control
11 Send *CONNECT RV
12 Send *DISCONNECT RV
```

CONNECT RV

Command:	CONNECT RV
Command Syntax:	CONNECT RV [MOTORS]
Code Sample:	<pre>Send "CONNECT RV" Send "CONNECT RV MOTORS"</pre>
Range:	N/A
Describe:	<p>The "CONNECT RV" command configures the TI-Innovator™ Hub software to work with the TI-Innovator™ Rover.</p> <p>It establishes the connections to the various devices on the Rover – two motors, two encoders, one gyroscope, one RGB LED and one color sensor. It also clears the various counters and sensor values. The optional 'MOTORS' parameter configures only the motors and allows direct control of motors without the additional peripherals.</p>
Result:	<p>Connects the Rover Vehicle to the TI-Innovator™ Hub.</p> <p>This establishes connections with the motor driver, color sensor, gyroscope, ultrasonic ranger, and RGB LED.</p> <p>The Rover is now ready to be programmed</p>
Type or Addressable Component:	All components of the Rover - two motors, two encoders, one gyroscope, one RGB LED and one color sensor.

Send "DISCONNECT RV"

SEND("DISCONNECT RV") Commands

DISCONNECT RV - disconnects all the hardware peripherals from the Hub.

Format: Send("DISCONNECT RV")

- Send("DISCONNECT RV")

CE Calculators

```
NORMAL FLOAT AUTO REAL RADIAN HP
MODE MENU (On/Off) F1-F8

PROGRAM:P
:Send("DISCONNECT RV")
```

TI-Nspire™ CX

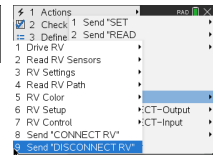

DISCONNECT RV

Command:	DISCONNECT RV
Command Syntax:	DISCONNECT RV
Code Sample:	Send "DISCONNECT RV" DISCONNECT RV
Range:	N/A
Describe:	The " DISCONNECT RV " command removes the logical connections between the TI-Innovator™ Hub and the TI-Innovator™ Rover. It also clears the counters and sensor values. It allows the use of the breadboard port of the TI-Innovator™ Hub with other devices.
Result:	The TI-Innovator™ Hub is now logically disconnected from the TI-Innovator™ Rover
Type or Addressable Component:	N/A

TI-Innovator™ Rover – Programmable Component Data Sheets

The TI-Innovator™ Rover Programmable Component Data Sheets include the following; a product name or number, a brief description, a product image, specifications, how the component connects to the TI-Innovator™ Hub, and Rover commands with simple code samples.

Device

Device	Category
Rover (RV)	Accessory

Sensors

Sensors	Category
Rotary Encoders	Motion and Distance Sensor
Gyroscope	Motion and Distance Sensor
Ultrasonic Ranger	Motion and Distance Sensor
Color Sensor	Environmental Sensor
On-Board Light Brightness Sensor (On Hub)	Environmental Sensor

Controllable Devices

Controllable Devices	Category
Electric Motors	Motors
RGB (Red-Green-Blue) LED	LEDs and Displays
On-Board Speaker (on Hub)	Sound Output

TI-Innovator™ Rover



Title	TI-Innovator™ Rover Data Sheet
TI Item Name	TI-Innovator™ Rover
Quantity	1
Included in	TI-Innovator™ Rover
Description	TI-Innovator™ Rover is a two-wheeled programmable robotic vehicle which works with the TI-Innovator™ Hub with TI LaunchPad™ Board.
Category	Accessory
Hub Connection	See: Connecting TI-Innovator™ Rover
Assembly Instructions	See: Exploring the Assembled TI-Innovator™ Rover
Precautions	See: General Precautions
Specifications	See: TI-Innovator™ Rover Setup Requirements

Rover Commands

Sketch Object	RV				
Command Syntax					
Code Sample:	<table border="1"><thead><tr><th>Desired Action</th><th>Code Sample</th></tr></thead><tbody><tr><td>Configure Hub for additional commands such as: RV Forward 2 RV Left</td><td>Send "CONNECT RV"</td></tr></tbody></table>	Desired Action	Code Sample	Configure Hub for additional commands such as: RV Forward 2 RV Left	Send "CONNECT RV"
Desired Action	Code Sample				
Configure Hub for additional commands such as: RV Forward 2 RV Left	Send "CONNECT RV"				

TI-Innovator™ Rover On-Board Rotary Encoders Data Sheet

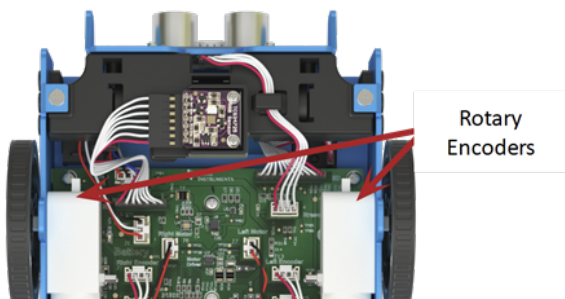

Title	TI-Innovator™ Rover Rotary Encoders
TI Item Name	Built into the TI-Innovator™ Rover
Quantity	2 - 1 for each wheel
Included in	TI-Innovator™ Rover
Description	Calculates linear distance by detecting how many rotations the wheels make as the Rover moves. Assists in balancing and aligning the wheels.
Category	Motion and Distance Sensors
Hub Connection	on-board Rover
Assembly Instructions	Not Applicable
Precautions	Do not unscrew the case enclosure. Encoder has sharp edges that should not be exposed.
Specifications	Not Applicable

TI-Innovator™ Rover On-Board Gyroscope Data Sheet

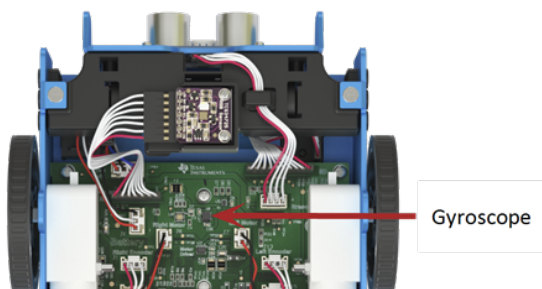

Title	TI-Innovator™ Rover Gyroscope
TI Item Name	Built into the TI-Innovator™ Rover
Quantity	1
Included in	TI-Innovator™ Rover
Description	Calculates angular displacement and heading as it maintains orientation.
Category	Motion and Distance Sensors
Hub Connection	on-board Rover
Assembly Instructions	Not Applicable
Precautions	Not Applicable
Specifications	Not Applicable

TI-Innovator™ Rover On-Board Ultrasonic Ranger Data Sheet



Title	Ultrasonic Ranger
TI Item Name	Built into the Rover
Quantity	1
Included in	TI-Innovator™ Rover
Description	Non-contact measurement module that reads distance from obstacle in meters.
Category	Motion and Distance Sensors
Hub Connection	On-board the Rover
Assembly Instructions	Not Applicable
Precautions	
Specifications	Measures distances up to 4 m

Rover Commands

Sketch Object	RV.RANGER
Command Syntax	Send("READ RV.RANGER")

Code Sample:	Desired Action	Code Sample
	Connects the Rover to the TI-Innovator Hub. This establishes connections with the motor driver, color sensor, gyroscope, ultrasonic ranger, and proximity sensors.	CONNECT RV
	Returns the current distance from the	READ RV.RANGER Get (R)

Rover Commands

	Desired Action	Code Sample
	front of the Rover to an obstacle. If there is no obstacle detected, a range of 10.00 meters is reported	

TI-Innovator™ Rover On-Board Color Sensor Data Sheet

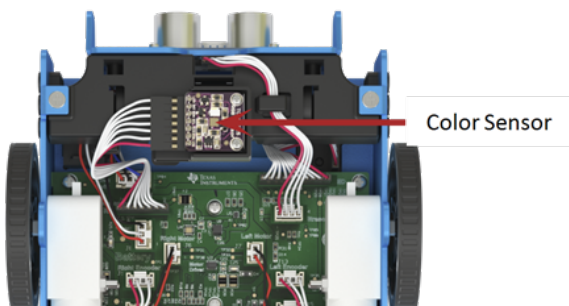

Title	TI-Innovator™ Rover Color Sensor
TI Item Name	Built into the TI-Innovator™ Rover
Quantity	1
Included in	TI-Innovator™ Rover
Description	Bottom-mounted color sensor detects the color of the surface. Can also detect gray-level scale of black (0) to white (255). Measures surface color. Used to identify colors and execute Rover Hub commands based on color.
Category	Environmental Sensors
Hub Connection	on-board Rover
Assembly Instructions	Not Applicable
Precautions	Do not unplug the cable. If it becomes unattached see proper positioning as shown above.
Specifications	Not Applicable

Rover Commands

Sketch Object	RV.COLORINPUT RV.COLORINPUT.RED RV.COLORINPUT.GREEN RV.COLORINPUT.BLUE RV.COLORINPUT.GRAY
---------------	---

Command Syntax

Rover Commands

Code Sample:	Desired Action	Code Sample

On-Board Light Brightness Sensor Data Sheet

Light Brightness Sensor



Title	On-Board Light Brightness Sensor
TI Item Name	Built into the Hub
Description	Built-in light brightness sensor located at the bottom of the Hub. The sensor detects light intensity.
Category	Environmental Sensors
Hub Connection	on-board Hub
Assembly Instructions	Not Applicable
Precautions	Not Applicable
Specifications	Not Applicable

HUB Commands

Sketch Object	BRIGHTNESS
Command Syntax	Send("READ BRIGHTNESS")

Code Sample:	Desired Action	Code Sample
	Read the built-in light brightness sensor	Send ("READ BRIGHTNESS") Get (B)

TI-Innovator™ Rover On-Board Electric Motors Data Sheet

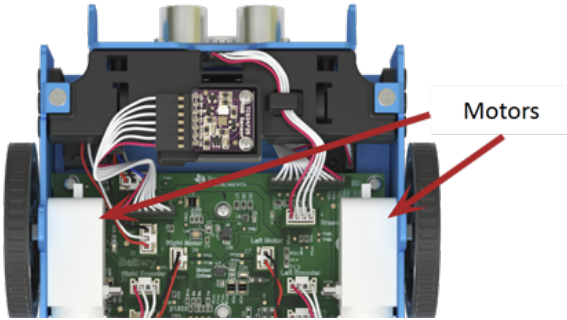

Title	TI-Innovator™ Rover Motors
TI Item Name	Built into the TI-Innovator™ Rover
Quantity	2 – 1 on each wheel with electric motor and rotary encoder to track rotations.
Included in	TI-Innovator™ Rover
Description	Motors that can be programmed to move the wheels independently and at variable speeds.
Category	Motors
Hub Connection	on-board Rover
Assembly Instructions	Not Applicable
Precautions	Not Applicable
Specifications	Not Applicable

Rover Commands	Send "SET RV.MOTORS"
Sketch Object	RV.MOTORS
Command Syntax	

Code Sample:	Desired Action	Code Sample
	Direct control of	Send "SET RV.MOTORS"

Rover Commands Send "SET RV.MOTORS

Desired Action	Code Sample
motors.	<pre>[SET] RV.MOTORS [LEFT] [CW CCW] <pwm value BRAKE COAST> [RIGHT] [CW CCW] <pwm value BRAKE COAST> [DISTANCE ddd [M [UNITS] REV FT]] [TIME s.ss]</pre>

TI-Innovator™ Rover On-Board RGB (Red-Green-Blue) LED Data Sheet



Title	TI-Innovator™ Rover RGB (Red-Green-Blue) LED
TI Item Name	Built into the TI-Innovator™ Rover
Quantity	1
Included in	TI-Innovator™ Rover
Description	Light-emitting diode with independently adjustable red, green and blue elements. Can produce a wide variety of colors.
Category	LEDs and Displays
Hub Connection	on-board Rover
Assembly Instructions	Not Applicable
Precautions	Not Applicable
Specifications	Not Applicable

Rover Commands

Sketch Object RV.COLOR

Command Syntax

Code Sample:	Desired Action	Code Sample
	Configure LED Note: RV.COLOR supports the same functions	<pre>Send("SET RV.COLOR 255 0 255")</pre>

Rover Commands

	Desired Action	Code Sample
	as the Hub COLOR object	

On-Board Speaker Data Sheet

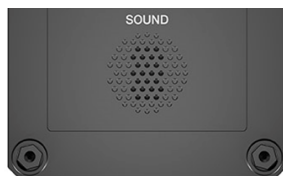

Speaker (at back of Hub) is addressable as "SOUND" in Hub command strings.

Title	On-Board Speaker
TI Item Name	Built into the Hub
Description	Built-in speaker located at the back of the Hub. It converts electrical current into sound you can hear.
Category	Sound Output
Hub Connection	on-board Hub
Assembly Instructions	Not Applicable
Precautions	Not Applicable
Specifications	Not Applicable

HUB Commands

Sketch Object	SOUND
Command Syntax	Send("SET SOUND ...") Frequency in Hz or Note as C1, CS1, D2, ... [TIME duration in seconds]

Code Sample:	Desired Action	Code Sample
	Play tone at 261.23 Hz	<code>Send("SET SOUND 261.23")</code>
	Evaluate the expression 2^8 (= 256) and play that tone	<code>Send("SET SOUND eval (2^8)")</code>
	Evaluate the expression 2^8 (= 256) and play that	<code>Send("SET SOUND eval (2^8) TIME .25")</code>

HUB Commands

	Desired Action	Code Sample
	tone for .25 seconds	
	Evaluate the expression 2^9 (= 512) and play that tone for 0.25 seconds (result of evaluating $1/4$)	<code>Send("SET SOUND eval (2^9) TIME eval (1/4) ")</code>
	Turn speaker off	<code>Send("SET SOUND OFF")</code>

I/O Modules Data Sheets

The TI-Innovator™ I/O Module Data Sheets include the following; a product name and number, a brief description, a product image, specifications, how the component connects to the TI-Innovator™ Hub, and Hub commands with simple code samples.

Troubleshoot problems with your TI-Innovator™ I/O Modules with these test programs.

Topic Links

- [Environmental Sensors](#)
- [LEDs and Display Sensors](#)
- [Motion and Distance Sensors](#)
- [Motors](#)
- [Power and Signal Sensors](#)

Environmental Sensors

Topic Links

- [Analog Light Sensor Data Sheet](#)
- [Moisture Sensor Data Sheet](#)
- [Temperature Sensor](#)
- [Temperature & Humidity Sensor Data Sheet](#)
- [Water Pump Data Sheet](#)

Analog Light Sensor Data Sheet

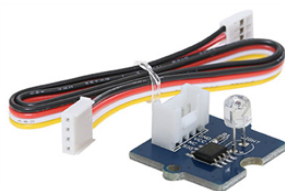

Title	Analog Light Sensor
TI Item Name	STEMKT/AC/A
Description	Sensor that detects the light intensity of the environment.
Category	Environmental Sensors
Hub Connection	4-Pin Cable to any of these ports: IN 1, IN 2, IN 3
Assembly Instructions	Not applicable
Precautions	Light sensor leads may break if bent repeatedly
Specifications	Maximum voltage: 150, Maximum power: 100, Environmental Temp: -30~+70, Spectrum Peak Value: 540

HUB Commands

Sketch Object	LIGHTLEVEL
Command Syntax	Send("READ LIGHTLEVEL n")

Code Sample:	Desired Action	Code Sample
	Configure the program to use LIGHTLEVEL on port IN 1	Send("CONNECT LIGHTLEVEL 1 TO IN 1")
Read the light sensor	Send("READ LIGHTLEVEL 1") Get(L)	

Moisture Sensor Data Sheet

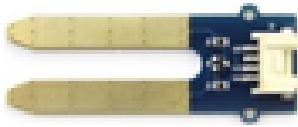

Title	Moisture Sensor
TI Item Name	STEMKT/AC/MM/A
Description	Detects the moisture of soil, and measures the dampness around the sensor. It can be used to decide if the plants in a garden need watering.
Category	Environmental Sensors
Hub Connection	4-Pin Cable to any of these ports: IN 1, IN 2, IN 3
Assembly Instructions	
Precautions	This sensor is not hardened against contamination or prolonged exposure to water and may be prone to electrolytic corrosion across the probes. This effect will be mitigated using the 3.3V of IN 1 and IN 2.
Specifications	Operating voltage: 3.3~5V, Operating current: 35mA, Sensor Output Value in dry soil: 0~ 300, Sensor Output Value in humid soil: 300~700, Sensor Output Value in water: 700 ~ 950, PCB size: 2.0cm X 6.0cm, Operating voltage: 3.3~5V, Operating current: 35mA, Sensor Output Value in dry soil: 0~ 300, Sensor Output Value in humid soil: 300~700 These output values are nonsensical. They may be for a 10 bit ADC.

HUB Commands

Sketch Object MOISTURE

Command Syntax

Code Sample:	Desired Action	Code Sample
	Connect moisture sensor to IN 1	Send "CONNECT MOISTURE 1 IN 1"
	Configure the measurement	Send "RANGE MOISTURE 1 0 100"

HUB Commands

	Desired Action	Code Sample
	range to be between 0 and 100. The range is an index and has no units.	
	Read the sensor	Send "READ MOISTURE 1" Get moisture

Temperature Sensor Data Sheet

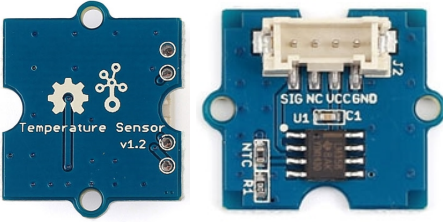

Title	Temperature Sensor
TI Item Name	STEMKT/AC/F
Description	Uses a thermistor to measure ambient temperature. The resistance of thermistor changes based on ambient temperature. This resistance value alters the output of a voltage divider which is measured by the TI-Innovator™ Hub and converted to a temperature value in centigrade degrees. The operating range is -40 to 125°C , with an accuracy of 1.5°C . This sensor is not waterproof and cannot be submerged.
Category	Environmental Sensors
Hub Connection	4-Pin Cable to any of these ports: IN 1, IN 2, IN 3
Assembly Instructions	
Precautions	
Specifications	Operating voltage: 3.3~5V Thermistor Zero power resistance: 100 KΩ Resistance Tolerance: ±1% Thermistor: NCP18WF104F03RC (NTC) Nominal B-Constant: 4250 ~ 4299K Operating temperature range: -40°C to 125°C Accuracy: ± 1.5°C
HUB Commands	
Sketch Object	TEMPERATURE
Command Syntax	

HUB Commands

Code Sample:	Desired Action	Code Sample
	Connected the temperature sensor to IN 1 port	Send "CONNECT TEMPERATURE 1 TO IN 1"
	Read the temperature value from the sensor in centigrade degrees	Send "READ TEMPERATURE 1" Get t

Temperature & Humidity Sensor Data Sheet

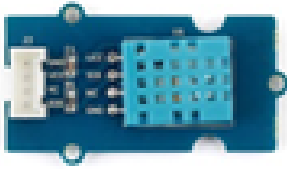

Title	Temperature & Humidity Sensor
TI Item Name	STEMKT/AC/HT/A
Description	Temperature & Humidity Sensor that measures percent relative humidity and the temperature in centigrade degrees.
Category	Environmental Sensors
Hub Connection	4-Pin Cable to any of these ports: IN 1, IN 2, IN 3
Assembly Instructions	
Precautions	
Specifications	Input Voltage: 3.3V & 5V Measuring Current: 1.3 - 2.1 mA Measuring Humidity Range: 20% - 90% RH Measuring Temperature Range: 0 - 50 °C degrees centigrade

HUB Commands

Sketch Object DHT

Command Syntax Sensor may not report correct readings during initial warm up period.

Code Sample:	Desired Action	Code Sample
	Connect the DHT sensor to port IN 2	Send "CONNECT DHT 1 TO IN 2 "
	Read the temperature from the DHT sensor	Send "READ DHT 1 TEMPERATURE" Get temperature
	Read the humidity from the DHT sensor	Send "READ DHT 1 HUMIDITY" Get humidity

Water Pump Data Sheet

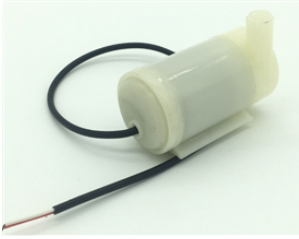

Title	Water Pump
TI Item Name	STEMKT/AC/WP/A
Description	The water pump is used in projects that use flowing water for irrigation etc.
Category	Environmental Sensors
Hub Connection	Connects to TI-Innovator™ Hub through a MOSFET module
Assembly Instructions	
Precautions	
Specifications	Submersible Pump Plastic tubing: 18" length Wires: 18" length

HUB Commands	See MOSFET commands
Sketch Object	N/A It is controlled through a MOSFET module.

Command Syntax		
Code Sample:	Desired Action	Code Sample

LED and Display Sensors

Topic Links

- [White LED Data Sheet](#)

White LED Data Sheet

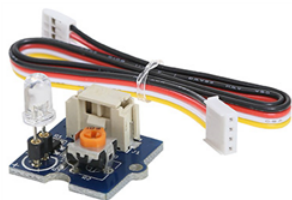

Title	White LED
TI Item Name	STEMKT/AC/C
Description	White LED module that bends to any position.
Category	LEDs and Displays
Hub Connection	4-Pin Cable to any of these ports: OUT 1, OUT 2, OUT 3
Assembly Instructions	Insert LED into socket - longer leg (lead) is positive (anode). If both leads are of equal length, the lead adjacent to the flat edge on LED casing is the negative (cathode) lead.
Precautions	Do not bend the leads repeatedly; this will weaken the wires and may cause them to break.
Specifications	Operating voltage: 3.3v/5v Emitting Color: White

HUB Commands

Sketch Object	LED
Command Syntax	Send("SET LED 1 TO ON/OFF [[BLINK TOGGLE] frequency] [[TIME] seconds]")

Code Sample:	Desired Action	Code Sample
	Configure the program to use LED on port OUT 1	Send("CONNECT LED 1 TO OUT 1")
	Turn LED ON	Send("SET LED 1 ON")
	Turn LED OFF	Send("SET LED 1 OFF")
	Turn external LED ON for 5 seconds	Send("SET LED 1 TO ON TIME 5")

HUB Commands

	Desired Action	Code Sample
	Turn external LED ON and blink it at 2 Hz (2 times a second) for 5 seconds	<pre>Send("SET LED 1 TO ON BLINK 2 TIME 5")</pre>

Motion and Distance Sensors

Topic Links

- [Magnetic field \(Hall Effect\) Sensor Data Sheet](#)
- [Ultrasonic Ranger Data Sheet](#)

Magnetic field (Hall Effect) Sensor Data Sheet

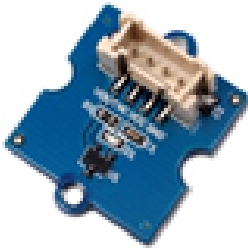

Title	Hall Sensor
TI Item Name	STEMKT/AC/HS/A
Description	Measures the magnetic field around the sensor using the Hall Effect. The sensor reports a low value in the presence of a magnetic field and a high value in the absence of one. It can be used to detect when a magnet is close to the sensor.
Category	Motion and Distance Sensors
Hub Connection	4-Pin Cable to any of these ports: IN 1, IN 2, IN 3
Assembly Instructions	
Precautions	
Specifications	Dimensions: 130mm x 90mm x 9.5mm Weight: G.W 6g

HUB Commands

Sketch Object ANALOG.IN

Command Syntax

Code Sample:	Desired Action	Code Sample
	Connect the Hall effect sensor to IN3 port	Send "CONNECT ANALOG.IN 1 TO IN 3"
	Read the value of the magnetic field reported by the sensor	Send "READ ANALOG.IN 1" Get m

Ultrasonic Ranger Data Sheet



Title	Ultrasonic Ranger
TI Item Name	STEMKT/AC/E
Description	Non-contact measurement module that reads distance from sensor in meters.
Category	Motion and Distance Sensors
Hub Connection	4-Pin Cable to any of these ports: IN 1, IN 2
Assembly Instructions	Not Applicable
Precautions	Sold separately , not included in the I/O Modules Pack
Specifications	Operating voltage: 3.3~5V Operating current: 15mA Ultrasonic frequency: 42kHz Measuring range: 3-400m Resolution: 1m, Output: PWM

HUB Commands

Sketch Object	RANGER
Command Syntax	Send("READ RANGER n") Get(R)

Code Sample:	Desired Action	Code Sample
	Configure the program to use RANGER on port IN 1	Send ("CONNECT RANGER 1 TO IN 1")
Read the Ultrasonic Ranger	Send ("READ RANGER 1") Get (R)	

Motors

Topic Links

- [Servo Motor Data Sheet](#)
- [Vibration Motor Data Sheet](#)

Servo Motor Data Sheet



There are two types of Servo motors, continuous and sweep. More about SERVO Motors

Title	Servo Motor
TI Item Name	STEMKT/AC/D
Description	360 degree, continuous rotation servo motor with gearing and feedback system; used in driving mechanism of robots.
Category	Motors
Hub Connection	4-Pin Cable to only this port: OUT 3
Assembly Instructions	Mount a gear to the top of the Servo Motor using one of the provided screws.
Precautions	Use an Auxiliary Power Source. Do not hold the Servo Motor's shaft while it is rotating. Also, do not rotate the Servo Motor by hand.
Specifications	Operating Speed: 110RPM (4.8V), 130RPM (6V) Stall Torque: 1.3kg.cm/18.09oz.in (4.8V), 1.5kg.cm/20.86oz.in(6V) Operating Voltage: 4.8V~6V

HUB Commands

Sketch Object	SERVO
Command Syntax	Send("SET SERVO n TO [CW/CCW] speed [[TIME] seconds] -- speed from -100 to 100, CW/CCW (Clockwise/Counterclockwise) optional, if speed <0, CCW, else CW unless CW/CCW keyword is specified, TIME optional, in seconds, default=1 second (for continuous servo operation) (CW/CCW required if TIME/seconds NOT specified.)

HUB Commands

Code Samples:	Desired Action for the SERVO.CONTINUOUS	Code Sample
	Configure the program to use SERVO on port OUT 3	<pre>Send("CONNECT SERVO 1 TO OUT 3")</pre>
	Set SERVO to turn Counterclockwise (CCW) at full (100%) speed for 2 seconds	<pre>Send("SET SERVO 1 CCW 100 2")</pre>
	Set SERVO to turn Clockwise (CW) at half (50%) speed for 1 second (default time if not specified)	<pre>Send("SET SERVO 1 CW 50")</pre>
	Turn SERVO Off	<pre>Send("SET SERVO 1 ZERO")</pre> <p>or</p> <pre>Send("SET SERVO 1 STOP")</pre>

More about SERVO Motors

There are two types of Servo motors, **continuous** and **sweep**.

- The motor in the I/O pack is a continuous motor. This motor rotates either clockwise (positive direction) or counter clockwise (negative direction) for a specified amount of time.
- Sweep servo motors turn only 90 degrees in each direction.

It is necessary to connect servo motors to the OUT 3 port. This port provides the 5 volts needed for these motors.

- You will also need to plug an external battery into the PWR micro USB port.
- You will also give a number, in this case 1, as part of identifying to an external device plugged into a port. (**Note:** In some cases you may have multiple devices of the same type connected to the TI-Innovator (e.g. temperature probes))

Code Sample:	<pre>Send("CONNECT SERVO.CONTINUOUS 1 TO OUT 3")</pre>
--------------	--

The first argument sets the speed and direction of the motor. You can use -100 to 100. Negative values are in the counter clockwise direction. Positive values are in the clockwise direction. Zero stops the motor.

The second argument is the amount of time in seconds to run the motor in the specified direction and speed. If there is no argument for time, then the motor will turn for one second.

The Wait command is used in the case to delay execution of commands on the calculator until the motor action is complete. This optional command is useful in delaying commands that might replace the current motor command before the desired end time.

Code Sample:	<pre>Send("SET SERVO.CONTINUOUS 1 -50 TIME 2") Wait 2</pre>
---------------------	---

You also have the options of using explicit CW and CCW settings with values for speed of 0 to 100.

Code Sample:	<pre>Send("SET SERVO.CONTINUOUS 1 CW 100 TIME 3") Wait 3</pre>
---------------------	--

This example prompts for the inputs to the **SERVO.CONTINUOUS** command.

The example also uses a While loop with getKey as a way for the user to control when the command to stop the motor is executed.

Code Sample:	<pre>ClrHome Disp "S:SPEED AND DIRECTION" Disp "ENTER VALUES -100 TO 100 FOR S" Disp "T:TIME IN SECONDS" Prompt S,T Send("SET SERVO.CONTINUOUS 1 eval(S) TIME eval(T)") Disp "PRESS 1 TO STOP THE MOTOR AND END THE PROGRAM" 0→K While K≠92 getKey→K End Send("SET SERVO.CONTINUOUS 1 0")</pre>
---------------------	---

Vibration Motor Data Sheet

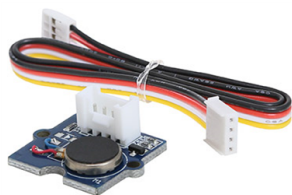

Title	Vibration Motor
TI Item Name	STEMKT/AC/B
Description	Coin type motor that vibrates when the input logic is HIGH.
Category	Motors
Hub Connection	4-Pin Cable to any of these ports: OUT 1, OUT 2, OUT 3
Assembly Instructions	Not Applicable
Precautions	Use an Auxiliary Power Source
Specifications	Operate Voltage: 3.0V to 5.5V Control Mode: Logic Level (When Logic HIGH, the motor is ON. When LOW, the motor is OFF.) Rated speed: 9000 rpm

HUB Commands

Sketch Object	VIB.MOTOR
Command Syntax	Send("SET VIB.MOTOR 1 TO pwm") - pwm from 0 to 255

Code Sample:	Desired Action	Code Sample
	Configure the program to use ANALOG.OUT on port OUT 1	Send ("CONNECT VIB.MOTOR 1 TO OUT 1")
	Turn OFF vibration motor	Send ("SET VIB.MOTOR 1 TO 0")
	Turn ON vibration motor at full power	Send ("SET VIB.MOTOR 1 TO 255")

HUB Commands

Desired Action	Code Sample
Turn ON vibration motor at half power	Send("SET VIB.MOTOR 1 TO 128")

Power and Signal Sensors

Topic Links

- MOSFET

MOSFET Data Sheet



Title	MOSFET
TI Item Name	STEMKT/AC/MOSFET/A
Description	<p>Enables you to control higher power projects with the TI-Innovator™ Hub. It is typically used to control DC motors and pumps. It cannot be used with AC power supplies.</p> <p>The MOSFET allows the connection of an external power source like AA batteries to power the motor and enables the TI-Innovator™ Hub to control the speed of the motor.</p> <p>This allows the TI-Innovator™ Hub to control a high power device without directly providing power to the device.</p> <p>The power supply positive lead is connected to the (+) screw terminal and the negative lead to the (-) screw terminal. The device positive lead is connected to the OUT screw terminal and the device negative is connected to the GND screw terminal.</p>
Category	
Hub Connection	Working voltage: 5V, Vin: 5 ~ 15V MOSFET Model: CJQ4435
Assembly Instructions	
Precautions	Indirect pin support.
Specifications	
HUB Commands	
Sketch Object	
Command Syntax	The MOSFET may be connected to OUT 1, OUT 2, or OUT 3. However, the device will not be shut off completely when using OUT 3.

HUB Commands

It is recommended to avoid using OUT 3.

Code Sample:	Desired Action	Code Sample
		Connect the MOSFET to the OUT 1 port
	Control the connected motor/pump at 50% speed for 3 seconds	Send "SET ANALOG.OUT 1 128 TIME 3"

TI-Innovator™ Breadboard Data Sheets

The TI-Innovator™ Breadboard Data Sheets include the following; a product name and number, a brief description, a product image, specifications, how the component connects to the TI-Innovator™ Hub, and simple code samples.

Topic Links

- Breadboard Components and Usable Pins
- Environmental Sensors
- LEDs and Displays
- Motors
- Power and Signal Control
- Passive Components

Breadboard Components and Usable Pins

Here is a list of all the components in our breadboard pack and the usable pins for each component.

Component	Use with pins
1 Breadboard	N/A
10 Male/Female Breadboard Jumper Cables	N/A
40 Male/Male Breadboard Jumper Cables	N/A
5 Green LED	BB 1-10
10 Red LED	BB 1-10
2 RGB (Red-Green-Blue) LED	BB 8-10
10 Resistor 100 Ohm	N/A
10 Resistor 1K Ohm	N/A
10 Resistor 10K Ohm	N/A
10 Resistor 100K Ohm	N/A
10 Resistor 10M Ohm	N/A
1 Diode	BB 1-10
1 Thermistor	BB 5,6,7 (analog input required)
1 SPDT Slide Switch	BB 1-10
1 8 Position SIP DIP Switch	BB 1-10 (digital input)

Component	Use with pins
1 8 100 Ohm Resistor SIP	N/A
1 Potentiometer with Knob	BB 5,6,7
1 Capacitor 100 μ F	N/A
1 Capacitor 10 μ F	N/A
1 Capacitor 1 μ F	N/A
1 7-Segment Display	BB 1-10
1 Small DC Motor	BB 1-10 (uses digital to generate software PWM)
2 TTL Power MOSFET	BB 1-10
1 TI Analog Temperature Sensor	BB 5,6,7 (analog input required)
1 Visible Light Sensor	BB 5,6,7 (analog input required)
1 4-AA Battery Holder	N/A
1 Infrared Receiver	BB 1-10 (digital input)
1 Infrared Transmitter	BB 1-10 (digital output)

Environmental Sensors

Topic Links

- [Thermistor Data Sheet](#)
- [TI Analog Temperature Sensor Data Sheet](#)
- [Visible Light Sensor Data Sheet](#)

Thermistor Data Sheet



Title	Thermistor
TI Item Name	STEMEE/AC/THERM/A
Description	Resistor whose resistance changes based on temperature. Used for measurement and control.
Category	Environmental Sensors
Hub Connection	breadboard circuit
Assembly Instructions	No polarity
Precautions	Not Applicable
Specifications	Resistance in Ohms @ 25°C: 10k Resistance Tolerance: ±1% B Value Tolerance: ±1% Operating Temperature: -40°C ~ 125°C Power – Max: 7.5mW

HUB Commands

Sketch Object	THERMISTOR
Command Syntax	Send("READ THERMISTOR n")

Code Sample:	Desired Action	Code Sample
	Configure the program to use THERMISTOR on pin BB 1	<pre>Send("CONNECT THERMISTOR 1 TO BB 1")</pre>
	Read the thermistor	<pre>Send("READ THERMISTOR 1") Get(T):Disp T</pre>

TI Analog Temperature Sensor Data Sheet



Title	TI Analog Temperature Sensor
TI Item Name	STEMEE/AC/TEMPSN/A
Description	Sensor that reports a voltage proportional to the ambient temperature within a range of -55°C to 130°C .
Category	Environmental Sensors
Hub Connection	breadboard circuit
Assembly Instructions	Not Applicable
Precautions	Not Applicable
Specifications	Accuracy at $+30^{\circ}\text{C}$ $\pm 2.5^{\circ}\text{C}$ (max) Accuracy at $+130^{\circ}\text{C}$ & -55°C ± 3.5 to $\pm 3.8^{\circ}\text{C}$ (max) Power Supply Voltage Range $+2.4\text{V}$ to $+5.5\text{V}$ Current Drain $10\ \mu\text{A}$ (max), Nonlinearity $\pm 0.4\%$ (typ), Output Impedance $160\ \Omega$ (max), Load Regulation $0\ \mu\text{A} < \text{IL} < +16\ \mu\text{A}$ See: Detailed Technical documentation.

HUB Commands

Sketch Object	TEMPERATURE
Command Syntax	Send("READ TEMPERATURE n")

Code Sample:	Desired Action	Code Sample
	Configure the program to use TEMPERATURE on pin BB 1	<pre>Send("CONNECT TEMPERATURE 1 TO BB 1")</pre>
	Read the temperature sensor	<pre>Send("READ TEMPERATURE 1") Get (T):Disp T</pre>

Visible Light Sensor Data Sheet



Title	Visible Light Sensor
TI Item Name	STEMEE/AC/LHTSEN/A
Description	Sensor that reports the level of ambient light.
Category	Environmental Sensors
Hub Connection	breadboard circuit
Assembly Instructions	Not Applicable
Precautions	Not Applicable
Specifications	

HUB Commands

Sketch Object	LIGHTLEVEL or ANALOG.IN
Command Syntax	Send("READ LIGHTLEVEL n")

Code Sample:	Desired Action	Code Sample
	Configure the program to use LIGHT LEVEL on pin BB 4	<pre>Send("CONNECT LIGHTLEVEL 1 TO BB 4")</pre>
	Read the light sensor	<pre>Send("READ LIGHTLEVEL 1") Get(L):Disp L</pre>

LEDs and Displays

Topic Links

- [Green LED Data Sheet](#)
- [RGB \(Red-Green-Blue\) LED Data Sheet](#)
- [Red LED Data Sheet](#)
- [Diode Data Sheet](#)
- [7-segment Display Data Sheet](#)
- [Infrared Receiver Data Sheet](#)
- [Infrared Transmitter Data Sheet](#)

Green LED Data Sheet



Title	Green LED
TI Item Name	STEMEE/AC/LED/A
Description	Light-emitting diode that emits green light when current passes through it.
Category	LEDs and Displays
Hub Connection	breadboard circuit
Assembly Instructions	Longer leg (lead) is positive (anode). If both leads are of equal length, the lead adjacent to the flat edge on LED casing is the negative (cathode) lead.
Precautions	Do not insert the leads of LEDs directly into the Hub's Breadboard Connector. Assemble the components on the breadboard and use the provided jumper cables to connect the breadboard to the Hub.
Specifications	Voltage - Forward (Vf) (Typ): 2.1V, Current - Test: 10mA, Viewing Angle: 36°, Mounting Type: Through Hole.

HUB Commands

Sketch Object	LED or DIGITAL.OUT
Command Syntax	Send("SET LED i [TO] 0-255 [[BLINK TOGGLE] frequency] [[TIME] seconds]")

Code Sample:	Desired Action	Code Sample
		<pre>Send("SET DIGITAL.OUT 1 TO ON")</pre>

HUB Commands

	Desired Action	Code Sample
		<pre>Send("SET DIGITAL.OUT 1 TO OFF") Send("SET DIGITAL.OUT 1 TO ON TIME 5")</pre>

RGB (Red-Green-Blue) LED Data Sheet



Title	RGB (Red-Green-Blue) LED
TI Item Name	STEMEE/AC/LED/B
Description	Light-emitting diode with independently adjustable red, green and blue elements. Can produce a wide variety of colors..
Category	LEDs and Displays
Hub Connection	breadboard circuit
Assembly Instructions	Not Applicable
Precautions	Do not insert the leads of LEDs directly into the Hub's Breadboard Connector. Assemble the components on the breadboard and use the provided jumper cables to connect the breadboard to the Hub.
Specifications	Not Applicable

HUB Commands

Sketch Object	RGB
Command Syntax	Send("SET RGB 1 TO r g b") - r = red value, g = green value, b = blue value Send("SET RGB 1 TO r g b [[BLINK TOGGLE] frequency] [[TIME] seconds]")

Code Sample:	Desired Action	Code Sample
	Configure LED	<pre>Send("SET RGB 1 ON ON OFF") Send("SET RG 1 255 128 0") Send("SET RGB 1 255 128 0 TIME 10") Send("SET RGB 1 255 128 0 BLINK 20 TIME 10")</pre>

HUB Commands

	Desired Action	Code Sample
		<pre>Send("SET RED 1 0") Send("SET GREEN 1 128 BLINK 2 TIME 10")</pre>

Red LED Data Sheet



Title	Red LED
TI Item Name	STEMEE/AC/LED/C
Description	Light-emitting diode that emits red light when current passes through it.
Category	LEDs and Displays
Hub Connection	breadboard circuit
Assembly Instructions	Longer leg (lead) is positive (anode). If both leads are of equal length, the lead adjacent to the flat edge on LED casing is the negative (cathode) lead.
Precautions	Do not insert the leads of LEDs directly into the Hub's Breadboard Connector. Assemble the components on the breadboard and use the provided jumper cables to connect the breadboard to the Hub.
Specifications	Voltage - Forward (Vf) (Typ): 2V, Current – Test: 10mA, Viewing Angle: 60°, Mounting Type: Through Hole

HUB Commands

Sketch Object	LED or DIGITAL.OUT
Command Syntax	Send("SET LED n ...") ON/OFF [BLINK frequency] [TIME duration]

Code Sample:	Desired Action	Code Sample
	Configure LED	
		<pre>Send("SET DIGITAL.OUT</pre>

HUB Commands

Desired Action	Code Sample
	<pre>1 TO ON") Send("SET DIGITAL.OUT 1 TO OFF") Send("SET DIGITAL.OUT 1 TO BLINK 2 TIME 5") Send("SET DIGITAL.OUT 1 TO ON TIME 5")</pre>

Diode Data Sheet



Title	Diode
TI Item Name	STEMEE/AC/DIO/A
Description	Component that allows an electric current to pass in one direction, while blocking current in the opposite direction.
Category	LEDs and Displays
Hub Connection	breadboard circuit
Assembly Instructions	Lead near grey band is cathode (negative pin)
Precautions	Not Applicable
Specifications	Voltage - DC Reverse (V_r) (Max): 100V, Current - Average Rectified (I_o): 200mA, Voltage - Forward (V_f) (Max) @ I_f : 1V @ 10mA, Speed: Small Signal =< 200mA (I_o), Any Speed, Current - Reverse Leakage @ V_r : 5 μ A @ 75V, Capacitance @ V_r , F: 4pF @ 0V, 1MHz, Operating Temperature - Junction: -65°C ~ 175°C

7-segment Display Data Sheet



Title	7-segment Display
TI Item Name	STEMEE/AC/DISP/A
Description	Array of LEDs arranged to display numbers and some alphabetic characters. Also has an LED for a decimal point.
Category	LEDs and Displays
Hub Connection	breadboard circuit
Assembly Instructions	Not Applicable
Precautions	Not Applicable
Specifications	20mA max per segment, Vf:2V

HUB Commands

Sketch Object	DIGITAL.OUT
Command Syntax	Send("SET DIGITAL.OUT n ON") - n = 1 to 7

Code Sample:	Desired Action	Code Sample
	Configure the program to use 7 DIGITAL.OUT on pins BB 1 - 7	<pre>For (N, 1, 7) Send ("CONNECT DIGITAL.OUT eval(N) TO BB eval(N) ") Send ("SET DIGITAL.OUT eval(N) ON") End</pre>

Infrared Receiver Data Sheet



Title	Infrared Receiver
TI Item Name	STEMEE/AC/REC/A
Description	Side emitting Infrared LED, designed to be paired with the LTR-301 Photo-Transistor.
Category	LEDs and Displays
Hub Connection	breadboard circuit
Assembly Instructions	Not Applicable
Precautions	Not Applicable
Specifications	Power Dissipation: 100mW, Peak Forward Current: 3A with 300 x 1 μ s pulses per second, Continuous Forward Current: 50 mA, Reverse Voltage: 5V, Forward Voltage: 1.2V, Operating Temperature Range: -55°C - 100°C, Peak Wavelength: 940 nM, Viewing Angle: 40°

HUB Commands

Sketch Object	DIGITAL.IN	
Command Syntax	Send("READ DIGITAL.IN n")	
Code Sample:	Desired Action	Code Sample
		<pre>Send ("CONNECT DIGITAL.IN 1 TO BB 2")</pre>
		<pre>Send ("READ DIGITAL.IN 1") Get (D) :Disp D</pre>

Infrared Transmitter Data Sheet



Title	Infrared Transmitter
TI Item Name	STEMEE/AC/TRANS/A
Description	Side sensing Infrared photo transistor, designed to be paired with the LTE-301 Infrared Emitter.
Category	LEDs and Displays
Hub Connection	breadboard circuit
Assembly Instructions	Not Applicable
Precautions	Not Applicable
Specifications	Power Dissipation: 100mW, Collector-Emitter Voltage: 30V, Emitter-Collector Voltage: 5V, Operating Temperature: -40°C to 85°C, Storage Temperature: -55°C to 100°

HUB Commands

Sketch Object	DIGITAL.OUT
Command Syntax	Send("SET DIGITAL.OUT n ON")

Code Sample:	Desired Action	Code Sample
		<pre>Send ("CONNECT DIGITAL.OUT 1 TO BB 5") Send ("SET DIGITAL.OUT 1 ON")</pre>

Motors

Small DC Motor Data Sheet



Title	Small DC Motor
TI Item Name	STEMEE/AC/MOTOR/A
Description	Motor that converts direct current electrical power into mechanical power.
Category	Motors
Hub Connection	breadboard circuit
Assembly Instructions	Not Applicable
Precautions	Not Applicable
Specifications	Nominal Voltage: 4.7V, Operating Voltage: 2.0-5.5V, No Load Speed: 19900 r/min, No Load Current: 0.11A, At Maximum Efficiency of Torque: 0.14mN.m (1.4g.cm), At Maximum Efficiency of Output: 0.23W, Stall Torque: 0.7mN.m(7.1g.cm), Stall Current: 0.42A

HUB Commands

Sketch Object	DCMOTOR
Command Syntax	Send("SET DCMOTOR n TO frequency [duty [TIME] seconds]") frequency - 1 to 500Hz duty - 1 to 99% duty cycle (default: 50%) seconds = 1s default

Code Sample:	Desired Action	Code Sample
		Send("SET DCMOTOR 1 TO 50 TIME 5")

Power and Signal Control

Topic Links

- [SPDT Slide Switch Data Sheet](#)
- [8 Position DIP Switch Data Sheet](#)
- [8 100 Ohm Resistor SIP Package Data Sheet](#)
- [TTL Power MOSFET Data Sheet](#)

SPDT Slide Switch Data Sheet



Title	SPDT Slide Switch
TI Item Name	STEMEE/AC/SWIT/A
Description	Single pole, double throw switch. Slide the switch knob back and forth to open and close contacts.
Category	Power and Signal Control
Hub Connection	breadboard circuit
Assembly Instructions	Not Applicable
Precautions	Not Applicable
Specifications	30V, 200mA

HUB Commands

Sketch Object	SWITCH
Command Syntax	Send("READ SWITCH n")

Code Sample:	Desired Action	Code Sample
	Configure the program to use SWITCH on port BB 1	<pre>Send("CONNECT SWITCH 1 TO BB 1") Send("READ SWITCH 1") Get(T):Disp T</pre>

8 Position DIP Switch Data Sheet



Title	8 Position DIP Switch
TI Item Name	STEMEE/AC/SWIT/B
Description	Set of 8 slide switches used to customize the behavior of the circuit components for specific situations.
Category	Power and Signal Control
Hub Connection	breadboard circuit
Assembly Instructions	Not Applicable
Precautions	Not Applicable
Specifications	'0.100", 100mA, 20VDC

HUB Commands

Sketch Object	DIGITAL.IN
Command Syntax	Send("READ DIGITAL.IN n") - n = 1 to 8 or Send("READ SWITCH n") - n = 1 to 8

Code Sample:	Desired Action	Code Sample
	Configure the program to use 8 SWITCHs on pins BB 1 - 8	For (N, 1, 8) Send("CONNECT SWITCH eval(N) TO BB eval(N)") Send("READ SWITCH eval(N)") Get(S):Disp S End

8 100 Ohm Resistor SIP Package Data Sheet



Title	8 100 Ohm resistor SIP Package
TI Item Name	STEMEE/AC/RES/E
Description	8 100 Ohm resistor SIP package for use with the 8 Position DIP Switch.
Category	Power and Signal Control
Hub Connection	breadboard circuit
Assembly Instructions	Not Applicable
Precautions	Not Applicable
Specifications	Bussed array

TTL Power MOSFET Data Sheet

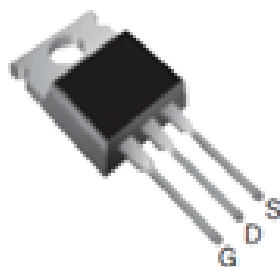

Title	TTL Power MOSFET
TI Item Name	STEMEE/AC/MOSFET/A
Description	Transistor used for amplifying or switching electronic signals.
Category	Power and Signal Control
Hub Connection	breadboard circuit
Assembly Instructions	Connect the G-GATE to the BB pin of the TI-Innovator™ Hub, the D-DRAIN to the load being controlled (e.g., DC motor) and the S-SINK to ground.
Precautions	If the metal plate on the MOSFET becomes hot during use, disconnect the battery immediately and re-check all connections.
Specifications	supports 100A

HUB Commands

Sketch Object	RELAY or ANALOG.OUT
Command Syntax	Send("SET RELAY n TO ON/OFF [[TIME] seconds]") or Send("SET ANALOG.OUT n TO 0-255/ON/OFF [[BLINK] frequency] [[TIME] seconds]")
Code Sample:	Note: a MOSFET can either be used as an ON/OFF control (RELAY) or for finer control (ANALOG.OUT)

HUB Commands

	Desired Action	Code Sample
		<pre>Send("CONNECT RELAY 1 TO BB 7") Send("SET RELAY 1 ON")</pre>
		<pre>Send("CONNECT ANALOG.OUT 1 TO BB 7") Send("SET ANALOG.OUT 1 127")</pre>

Passive Components

Topic Links

- [Accessories](#)
- [Breadboard](#)
- [Capacitors](#)
- [Resistors](#)

Accessories

40-Pack Male to Male Breadboard Jumper Cable Data Sheet



Title	40-Pack Male to Male Breadboard Jumper Cables
TI Item Name	STEMEE/AC/CABKT/A
Description	Male to Male jumper cables for connecting components on the breadboard.
Category	Accessories
Hub Connection	breadboard circuit
Assembly Instructions	Not Applicable
Precautions	Cable lead may break if bent repeatedly
Specifications	Male to Male Pack of 40, 20cm

10-Pack Male to Female Breadboard Jumper Cable Data Sheet



Title	10-Pack Male to Female Breadboard Jumper Cables
TI Item Name	STEMEE/AC/CABKT/B
Description	Male to female jumper cables for connecting components on the breadboard.
Category	Accessories
Hub Connection	breadboard circuit

Title	10-Pack Male to Female Breadboard Jumper Cables
Assembly Instructions	Not Applicable
Precautions	Cable lead may break if bent repeatedly
Specifications	Male to Female Pack of 10, 20cm

4-AA Battery Holder Data Sheet

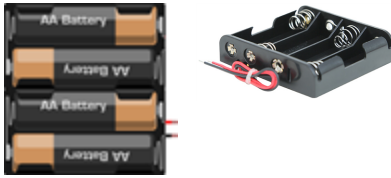

Title	4-AA Battery Holder
TI Item Name	STEMEE/AC/BATHLD/A
Description	4-AA battery holder with tinned solid leads for easy breadboard insertion.
Category	Accessories
Hub Connection	breadboard circuit
Assembly Instructions	Not Applicable
Precautions	Not Applicable
Specifications	BHC-341-1A with lead wires 150mm, Strip & Tin: 5mm+/-1mm, UL1007, AWG 26

Breadboard Data Sheet

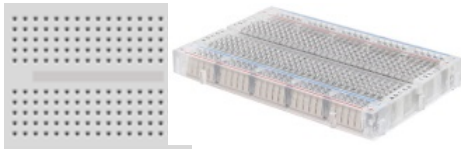

Title	Breadboard
TI Item Name	STEMEE/AC/BRDBD/A
Description	Platform for connecting the electronic components of a project by inserting component leads and jumper cables into pins.
Category	Breadboard
Hub Connection	breadboard circuit
Assembly Instructions	Not Applicable
Precautions	<p>Do not connect the positive and negative leads of a power source to the same group of 5 pins on the breadboard. Doing so could damage the breadboard and the power source. Observe the correct polarity: When connecting the breadboard to the Hub. When connecting components that are sensitive to polarity, such as LEDs and the TTL Power MOSFET.</p> <p>See also: TI-Innovator™ Hub Ports and Breadboard Usable Pins</p>
Specifications	45.7x35.6x9.4mm, 170 tie-point, POM plastic (150°C), Round Hole, with screwsx2pcs

Capacitors

Capacitor 100 μ F Data Sheet



Title	Capacitor 100μF
TI Item Name	STEMEE/AC/CAP/A
Description	Capacitor that temporarily stores an electric charge of up to 100 μ F.
Category	Capacitors
Hub Connection	breadboard circuit
Assembly Instructions	Longer leg (lead) is positive (anode). If both leads are of equal length, the lead adjacent to the colored strip on the casing is the negative (cathode) lead.
Precautions	Not Applicable
Specifications	Capacitance: 100 μ F, Tolerance: \pm 20%, Voltage Rating: 16V

Capacitor 10 μ F Data Sheet



Title	Capacitor 10μF
TI Item Name	STEMEE/AC/CAP/B
Description	Capacitor that temporarily stores an electric charge of up to 10 μ F.
Category	Capacitors
Hub Connection	breadboard circuit
Assembly Instructions	Longer leg (lead) is positive (anode). If both leads are of equal length, the lead adjacent to the colored strip on the casing is the negative (cathode) lead.

Title	Capacitor 10μF
Precautions	Not Applicable
Specifications	Capacitance: 10 μ F, Tolerance: \pm 20%, Voltage Rating: 16V

Capacitor 1 μ F Data Sheet



Title	Capacitor 1μF
TI Item Name	STEMEE/AC/CAP/C
Description	Capacitor that temporarily stores an electric charge of up to 1 μ F.
Category	Capacitors
Hub Connection	breadboard circuit
Assembly Instructions	Longer leg (lead) is positive (anode). If both leads are of equal length, the lead adjacent to the colored strip on the casing is the negative (cathode) lead.
Precautions	Not Applicable
Specifications	Capacitance: 1 μ F, Tolerance: \pm 20%, Voltage Rating: 16V

Resistors

Resistor 100 Ohm Data Sheet

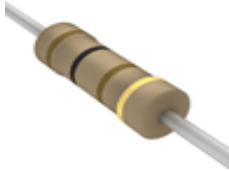

Title	Resistor 100 Ohm
TI Item Name	STEMEE/AC/RES/A
Description	Resistor that provides 100 Ohms of resistance in a circuit. Color Code Value: brown, black, brown.
Category	Resistors
Hub Connection	breadboard circuit
Assembly Instructions	No polarity
Precautions	Not Applicable
Specifications	'Resistance (Ohms): 100, Tolerance: $\pm 5\%$, Power (Watts): 0.5W, 1/2W, Temperature Coefficient: 0/ -400ppm/ $^{\circ}\text{C}$, Operating Temperature: $-55^{\circ}\text{C} \sim 155^{\circ}\text{C}$

Resistor 1K Ohm Data Sheet

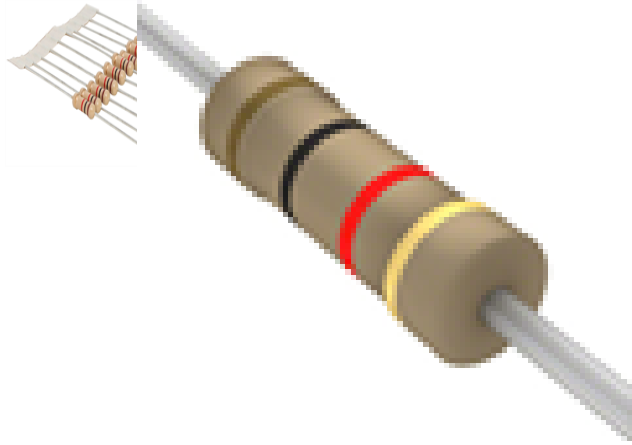

Title	Resistor 1K Ohm
TI Item Name	STEMEE/AC/RES/B
Description	Resistor that provides 1K Ohms of resistance in a circuit. Color Code Value: brown, black, red.
Category	Resistors
Hub Connection	breadboard circuit
Assembly Instructions	No polarity
Precautions	Not Applicable
Specifications	'Resistance (Ohms): 1K, Tolerance: $\pm 5\%$, Power (Watts): 0.5W, 1/2W, Temperature Coefficient: 0/ -400ppm/ $^{\circ}\text{C}$, Operating Temperature: $-55^{\circ}\text{C} \sim 155^{\circ}\text{C}$

Resistor 10K Ohm Data Sheet

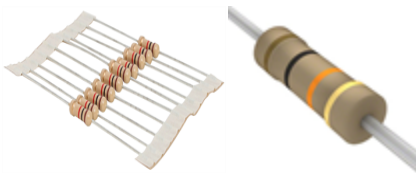

Title	Resistor 10K Ohm
TI Item Name	STEMEE/AC/RES/C
Description	Resistor that provides 10K Ohms of resistance in a circuit. Color Code Value: brown, black, orange.
Category	Resistors
Hub Connection	breadboard circuit
Assembly Instructions	No polarity
Precautions	Not Applicable
Specifications	'Resistance (Ohms): 10K, Tolerance: $\pm 5\%$, Power (Watts): 0.5W, 1/2W, Temperature Coefficient: 0/ - 400ppm/ $^{\circ}$ C, Operating Temperature: -55° C ~ 155° C

Resistor 100K Ohm Data Sheet

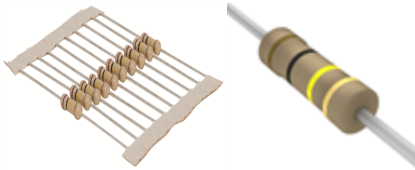

Title	Resistor 100K Ohm
TI Item Name	STEMEE/AC/RES/D
Description	Resistor that provides 100K Ohms of resistance in a circuit. Color Code Value: brown, black, yellow.
Category	Resistors
Hub Connection	breadboard circuit
Assembly Instructions	No polarity
Precautions	Not Applicable
Specifications	'Resistance (Ohms): 100K, Tolerance: $\pm 5\%$, Power (Watts): 0.5W, 1/2W, Temperature Coefficient: 0/ - 400ppm/ $^{\circ}$ C, Operating Temperature: -55° C ~ 155° C

Resistor 10M Ohm Data Sheet

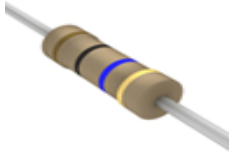

Title	Resistor 10M Ohm
TI Item Name	STEMEE/AC/RES/F
Description	Resistor that provides 10M Ohms of resistance in a circuit. Color Code Value: brown, black, blue.
Category	Resistors
Hub Connection	breadboard circuit
Assembly Instructions	No polarity
Precautions	Not Applicable
Specifications	'Resistance (Ohms): 10M, Tolerance: $\pm 5\%$, Power (Watts): 0.5W, 1/2W, Temperature Coefficient: 0/ - 400ppm/ $^{\circ}\text{C}$, Operating Temperature: $-55^{\circ}\text{C} \sim 155^{\circ}\text{C}$

Potentiometer with Knob Data Sheet



Title	Potentiometer with Knob
TI Item Name	STEMEE/AC/POTEN/A
Description	Variable resistor with knob used to change the resistance in a circuit.
Category	Resistors
Hub Connection	breadboard circuit
Assembly	Not Applicable

Title	Potentiometer with Knob
Instructions	
Precautions	Not Applicable
Specifications	1 Turn, 10K

HUB Commands

Sketch Object	POTENTIOMETER
Command Syntax	Send("READ POTENTIOMETER n")

Code Sample:	Desired Action	Code Sample
	Read potentiometer	<pre>Send("READ POTENTIOMETER 1") Get(P):Disp P</pre>

TI-SensorLink Adapter

What is TI-SensorLink Adapter?

TI-SensorLink Adapter is an accessory to TI-Innovator™ Hub to support the use of Vernier analog sensors with the Hub. TI-SensorLink expands STEM project possibilities by connecting select Vernier Sensors to TI-SensorLink, then to TI-Innovator™ Hub.

Note: TI-SensorLink is not a data collection solution. USB connected probes or TI-Nspire™ Lab Cradle are a superior solution for pure data collection and analysis.

TI-SensorLink – Industrial design and markings

Top view of TI-SensorLink Adapter.



Front view - Port for connecting probes and sensors



Back view - Port for connecting to the Hub



Bottom view - identifying label.



Supported Vernier Analog Sensors

We officially support these four Vernier analog sensors with TI-SensorLink.

Module	Ports	Image	Example code for TI-SensorLink
Stainless Steel Temperature Probe	TI-SensorLink		Connect To: Send "CONNECT VERNIER 1 TO IN1 AS TEMPERATURE" Send "READ VERNIER 1" Get T
ph Sensor	TI-SensorLink		Connect to: Send "CONNECT VERNIER 2 TO IN2 AS PH" Send "READ VERNIER 2" Get P
Gas Pressure Sensor	TI-SensorLink		Connect To: Send "CONNECT VERNIER 1 TO IN1 AS PRESSURE" Send "READ VERNIER 1" Get P
Dual-Range Force Sensor	TI-SensorLink		Connect To: Send "CONNECT VERNIER 2 TO IN2 AS FORCE" or Send "CONNECT VERNIER 2 TO IN2 AS FORCE50" Send "READ VERNIER 2" Get F
Low-g Accelerometer	TI-SensorLink		Connect To: Send "CONNECT VERNIER 1 TO IN 1 AS ACCEL" Send "READ VERNIER 1"
Light Sensor	TI-SensorLink		Connect To: Send "CONNECT VERNIER 1 TO IN 1 AS LIGHT" Send "READ VERNIER 1"

Module	Ports	Image	Example code for TI-SensorLink
Vernier Energy TI-SensorLink Sensor			Connect To: Send "CONNECT VERNIER 1 TO IN 1 AS ENERGY" Send "READ VERNIER 1"

Requirements for Vernier adapter:

Hardware:

- Add-on TI-SensorLink Adapter to TI-Innovator™ Hub
- Support a single Vernier analog sensor
- Will work on all three IN ports of Hub
 - Use with I2C port or the OUT ports is **NOT** supported - sketch will indicate an error
- The following sensors are supported
 - Stainless Steel Temperature Probe
 - pH Sensor
 - Gas Pressure Sensor
 - Dual-Range Force Sensor
 - Low-g Accelerometer Data Sheet
 - Light Sensor Data Sheet
 - Vernier Energy Sensor Data Sheet

Connecting the TI-SensorLink Adapter

Follow these set of steps in this order to connect and use the TI-SensorLink Adapter.

Connect the TI-SensorLink Adapter to the TI-Innovator™ Hub

TI-Sensor Link
Adapter



Provided Cable



TI-Innovator™ Hub

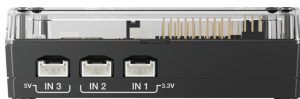

STEPS

1. Connect one end of the provided cable to the TI-SensorLink port labeled HUB.
2. Connect the other end of the provided cable to the port on the Hub labeled IN1.

Note: may also insert cable into IN2 or IN3.



Connect the TI-Innovator™ Hub to a Graphing Calculator

The TI-Innovator™ Hub connects by a USB cable to a graphing calculator or computer. The connection lets the Hub receive power and exchange data with the host.

See complete details (page 4).

Connect TI-SensorLink Adapter to a Vernier Sensor

TI-SensorLink Adapter



Vernier Sensor



Connecting TI-Sensor Link to one of the four supported Vernier Analog Sensors, using the analog sensor's attached connector.



STEPS

1. Connect the Vernier sensor to the TI-SensorLink (This example uses the Stainless Steel Temperature Probe)
2. From the connected graphing calculator, enter the following code:

```
Send "CONNECT VERNIER 1 TO IN1 AS TEMPERATURE"
```

```
Send "READ VERNIER 1"
```

```
Get T
```

Note: The new commands and keywords will either need to be typed in OR copied from an existing program. Please note that any typographical errors in the keywords will result in an error indication in the sketch.

See Code Samples for:

- Dual-Range Force Sensor
 - Gas Pressure Sensor
 - pH Sensor
 - Stainless Steel Temperature Probe
-

Precautions for the TI-SensorLink Adapter and Vernier Sensors

TI-SensorLink Adapter

- TI-SensorLink is **not** a data collection solution. USB connected probes or Lab Cradle remains a superior solution for pure data collection and analysis.
- The Hub commands for the TI-SensorLink with the Vernier analog sensors are currently **not** part of the Hub App (CE family) or the Hub menu (TI-Nspire™ CX).
- The new commands and keywords will either need to be typed in OR copied from an existing program. Please note that any typographical errors in the keywords will result in an error indication in the sketch.

Vernier Sensors

- Gas Pressure Sensor - The Gas Pressure Sensor sensing element will be damaged with direct contact to liquid.
 - pH Sensor - Place the electrode in pH 4 or pH 7 buffer solution. It should never be stored in distilled water. If the electrode is inadvertently stored dry for a short period of time, immerse the tip in the pH 4 buffer/KCl storage solution for a minimum of 8 hours prior to use.
 - Stainless Steel Temperature Probe -
 - Twisting the cable. Sometimes students twist or crimp the wire near the handle of the sensor. Over time, this can cause the wires to come loose and make the sensor stop working.
 - Overheating the sensor. When used in chemistry labs, students will sometimes lay the sensor on a hot plate and effectively "cook" the unit.
-

- The unit is not waterproof! Water can seep into the hilt of the sensor and damage the electronics. Only submerge the stainless steel portion the sensor into water when collecting data.
-

TI-SensorLink Adapter and Vernier Sensor Data Sheets

The TI-SensorLink Adapter Data Sheet and Vernier Sensor Data Sheets include the following; a product name and number, a brief description, a product image, specifications, how the component connects to the TI-Innovator™ Hub, and Hub commands with simple code samples.

Topic Links

- TI-SensorLink Adapter Data Sheet
- **Vernier Sensor Data Sheets**
 - Stainless Steel Temperature Probe Data Sheet
 - pH Sensor Data Sheet
 - Dual-Range Force Sensor Data Sheet
 - Gas Pressure Sensor Data Sheet
 - Low-g Accelerometer Data Sheet
 - Light Sensor Data Sheet
 - Vernier Energy Sensor Data Sheet

Note:

- TI-SensorLink is **not** a data collection solution. USB connected probes or Lab Cradle remains a superior solution for pure data collection and analysis.
- The Hub commands for the TI-SensorLink with the Vernier analog sensors are currently **not** part of the Hub App (CE family) or the Hub menu (TI-Nspire™ CX).
- The new commands and keywords will either need to be typed in OR copied from an existing program. Please note that any typographical errors in the keywords will result in an error indication in the sketch.

TI-SensorLink Adapter Data Sheet

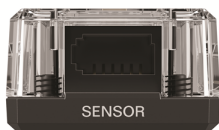

Title	TI-SensorLink Adapter
TI Item Name	STEMKT/AC/SL/A
Included in	TI-SensorLink Adapter
Quantity	1
Description	Accessory to TI-Innovator™ Hub to support use of Vernier analog sensors with Hub Note: Not a data collection solution <ul style="list-style-type: none">– USB connected probes or Lab Cradle remains a superior solution for pure data collection and analysis
Category	Adapter
Hub Connection	Two images of the TI-SensorLink Adapter. The left image shows the "SENSOR" version, and the right image shows the "HUB" version, which has a gold-colored circuit board visible through the clear top cover.
Assembly Instructions	N/A
Precautions	.
Specifications	

Stainless Steel Temperature Probe Data Sheet



Title	Vernier Stainless Steel Temperature Probe
TI Item Name	n/a
Vernier Order Code	TMP-BTA
Included in	Stainless Steel Temperature Probe
Quantity	1
Description	<p>The Stainless Steel Temperature Probe is a rugged, general-purpose temperature sensor that can be used in organic liquids, salt solutions, acids, and bases. Use it as you would use a thermometer for experiments in chemistry, physics, biology, Earth science, and environmental science.</p> <p>See Also: User Manual</p>
Category	Environmental Sensor
Hub Connection	TI-SensorLink Adapter for TI-Innovator™ Hub
Assembly Instructions	N/A
Precautions	<ol style="list-style-type: none">1. Twisting the cable. Sometimes students twist or crimp the wire near the handle of the sensor. Over time, this can cause the wires to come loose and make the sensor stop working.2. Overheating the sensor. When used in chemistry labs, students will sometimes lay the sensor on a hot plate and effectively "cook" the unit.3. The unit is not waterproof! Water can seep into the hilt of the sensor and damage the electronics. Only submerge the stainless steel portion the sensor into water when collecting data.
Specifications	<p>Temperature range: -40 to 135°C (-40 to 275°F)</p> <p>Maximum temperature that the sensor can tolerate</p>

Title	Vernier Stainless Steel Temperature Probe
	without damage: 150°C
	Typical Resolution:
	<ul style="list-style-type: none"> • 0.17°C (-40 to 0°C) • 0.03°C (0 to 40°C) • 0.1°C (40 to 100°C) • 0.25°C (100 to 135°C)
	See Also: Full Specifications here.

HUB Commands

Sketch Object VERNIER

Command Syntax

Code Sample:	Desired Action	Code Sample
	Read the temperature from the attached Vernier sensor	<pre>Send "CONNECT VERNIER 1 TO IN1 AS TEMPERATURE" Send "READ VERNIER 1" Get T</pre>

pH Sensor Data Sheet



Title	Vernier pH Sensor
TI Item Name	n/a
Vernier Order Code	PH-BTA
Included in	pH Sensor
Quantity	1
Description	Use the pH Sensor just as you would a traditional pH meter with the additional advantages of automated data collection, graphing, and data analysis See Also: User Manual
Category	Environmental Sensors
Hub Connection	TI-SensorLink Adapter for TI-Innovator™ Hub
Assembly Instructions	N/A
Precautions	Place the electrode in pH 4 or pH 7 buffer solution. It should never be stored in distilled water. If the electrode is inadvertently stored dry for a short period of time, immerse the tip in the pH 4 buffer/KCl storage solution for a minimum of 8 hours prior to use.
Specifications	<ul style="list-style-type: none">• Type: Sealed, gel-filled, epoxy body, Ag/AgCl• Response time: 90% of final reading in 1 second• Temperature range: 5 to 80°C (readings not compensated)• Range: pH 0–14• Accuracy: +/- 0.2 pH units• Isopotential pH: pH 7 (point at which temperature has no effect)• Default calibration values: slope: -3.838, intercept: 13.720• Shaft Diameter: 12 mm OD See Also: Full Specifications here.

HUB Commands

Sketch Object VERNIER

Command Syntax

Code Sample:	Desired Action	Code Sample
		Read the pH from the attached Vernier sensor

Gas Pressure Sensor Data Sheet



Title	Vernier Gas Pressure Sensor
TI Item Name	n/a
Vernier Order Code	GPS-BTA
Included in	Gas Pressure Sensor
Quantity	1
Description	<p>Used to monitor pressure changes in a gas. The range is wide enough to perform Boyle's law yet it is sensitive enough to conduct vapor-pressure or pressure-temperature experiments. Biology teachers can use the Gas Pressure Sensor to monitor transpiration or respiration in an enclosed environment.</p> <p>See Also: User Manual</p>
Category	Environmental Sensor
Hub Connection	TI-SensorLink Adapter for TI-Innovator™ Hub
Assembly Instructions	N/A
Precautions	The Gas Pressure Sensor sensing element will be damaged with direct contact to liquid.
Specifications	<ul style="list-style-type: none">• Pressure Range: 0 to 210 kPa (0 to 2.1 atm or 0 to 1600 mm Hg)• Accuracy: ± 4 kPa• Maximum pressure that the sensor can tolerate without permanent damage: 4 atm• Sensing Element: Honeywell SSCMRNN030PAAA5 <p>Note: There are two variants of the Gas Pressure Sensor. Version 1.3 of the sketch for TI-Innovator™ Hub includes the calibration constants for one of the two variants. The reference programs show how to use the CALIBRATE command to use the other type of Gas Pressure sensor.</p> <p>See Also: Full Specifications here.</p>

HUB Commands

Sketch Object VERNIER

Command Syntax

Code Sample:	Desired Action	Code Sample
		Read the gas pressure from the attached Vernier sensor

New in Sketch v 1.4

There is an additional variant of the Vernier Gas Pressure sensor with different calibration constants.

New keyword: **PRESSURE2**

The calibration constants are: 51.71 -25.86

Code Sample:	Send "CONNECT VERNIER 1 TO IN 1 AS PRESSURE2" Send "READ VERNIER 1" Get P
--------------	---

Dual-Range Force Sensor Data Sheet



Title	Vernier Dual-Range Force Sensor
TI Item Name	n/a
Vernier Order Code	DFS-BTA
Included in	Vernier Dual-Range Force Sensor
Quantity	1
Description	General-purpose sensor for measuring pushing and pulling forces. Two ranges allow you to measure forces as small as 0.01 newtons and as large as 50 newtons. See Also: User Manual
Category	Environmental Sensor
Hub Connection	TI-SensorLink Adapter for TI-Innovator™ Hub
Assembly Instructions	Designed to be mounted on a ring stand, cart, track, or force table in several different ways. Use a 13 mm rod extended through the hole in the Dual-Range Force Sensor. Tighten the included thumb screw.
Precautions	N/A
Specifications	± 10 N Range Resolution: 0.01 N ± 50 N Range Resolution: 0.05 N Note: There is a switch on this sensor to allow measuring: <ul style="list-style-type: none">- ± 10 N- ± 50 N See Also: Full Specifications here.

HUB Commands

Sketch Object VERNIER

Command Syntax

Code Sample:	Desired Action	Code Sample
		Read the force from the attached Vernier sensor in 10 N configuration
	Read the force from the attached Vernier sensor in 50 N configuration (Note that the CONNECT command includes FORCE50)	Send "CONNECT VERNIER 2 TO IN2 AS FORCE50" Send "READ VERNIER 2" Get F

Low-g Accelerometer Data Sheet

(Order Code- LGS-BTA)



Title	Low-g Accelerometer
TI Item Name	n/a
Vernier Order Code	LGA-BTA
Included in	Low-g accelerometer
Quantity	1
Description	The Low-g Accelerometer can be used for a wide variety of experiments and demonstrations, both inside the lab and outside. See Also: User Manual
Category	Environmental Sensor
Hub Connection	TI-SensorLink Adapter for TI-Innovator™ Hub
Assembly Instructions	N/A
Precautions	
Specifications	See: Full Specifications here.

Light Sensor Data Sheet

(Order Code- LS-BTA)



Title	Light Sensor
TI Item Name	n/a
Vernier Order Code	LS-BTA
Included in	Light Sensor
Quantity	1
Description	The Light Sensor can be used for measurements of light intensity in a variety of situations. See Also: User Manual
Category	Environmental Sensor
Hub Connection	TI-SensorLink Adapter for TI-Innovator™ Hub
Assembly Instructions	N/A
Precautions	The Light Sensor is sensitive enough to pick up the 60 or 120 Hz flicker of overhead fluorescent lamps, which may interfere with light experiments. If you think such interference may be occurring, try the following: <ul style="list-style-type: none">• First, eliminate all artificial light sources (except battery-powered flashlights) and try your experiment again.• Next, test the Light Sensor positioned as you plan to use it. Set the sampling at 1000 points/second for 0.1 second. If the flicker is the problem, you will see a drastic variation in the light intensity with a period of 60 or 120 Hz (50 or 100 Hz outside of North America).• If the overhead flicker is an issue, set the sampling rate to a number that is not a factor of 60. For example, using 30, 20, or 10 samples/s is worse than using 17, 23, 27 samples/s.
Specifications	See: Full Specifications here. Default calibration values 0–600 lux

Title	Light Sensor
	slope: 154 lux/V intercept: 0 lux 0–6000 lux
	slope: 1692 lux/V intercept: 0 lux 0–150000 lux
	slope: 38424 lux/V intercept: 0 lux

Vernier Energy Sensor Data Sheet

(Order Code- VES-BTA)



Title	Vernier Energy Sensor
TI Item Name	n/a
Vernier Order Code	VES-BTA
Included in	Energy Sensor
Quantity	1
Description	The Vernier Energy Sensor allows students to easily measure current and voltage. Source terminals connect to energy output sources such as model wind turbines or solar panels, and Load terminals connect to loads such as LEDs, water pumps, resistors, or variable loads.
	See Also: User Manual
Category	Environmental Sensor
Hub Connection	TI-SensorLink Adapter for TI-Innovator™ Hub
Assembly Instructions	N/A
Precautions	
Specifications	See: Full Specifications here.

TI-RGB Array

What is TI-RGB Array?

TI-RGB Array is an accessory to TI-Innovator™ Hub.

TI-RGB Array has 16 programmable RGB LEDs.

Multiple applications

- Smart greenhouse
- Binary counter
- STEAM projects
- Coding lessons

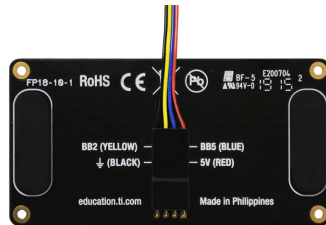

TI-RGB Array – Industrial design and markings

Top view of TI-RGB Array.



Bottom view - identifying label.



Requirements for TI-RGB Array:

Hardware:

Add-on TI-RGB Array to TI-Innovator™ Hub

Use Hub Sketch v1.4 or later

Connecting the TI-RGB Array

Follow these set of steps in this order to connect and use the TI-RGB Array.

Connect the TI-RGB Array to the TI-Innovator™ Hub

TI-RGB Array



Provided Cable



TI-Innovator™ Hub

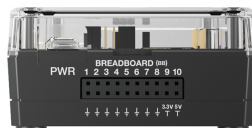

STEPS

1. Connect one end of the provided cable to the TI-RGB Array port labeled:



2. Connect the corresponding wires to the usable pins on the Hub labeled:

Red: 5V - power

Blue : BB5 - analog out

Yellow: BB2 - SPI signal

Black: GND - ground

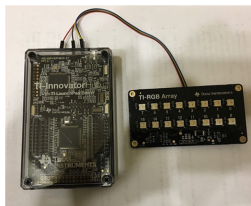
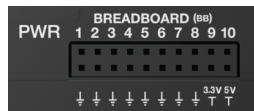

Connect the TI-Innovator™ Hub to a Graphing Calculator

The TI-Innovator™ Hub connects by a USB cable to a graphing calculator or computer. The connection lets the Hub receive power and exchange data with the host.

See complete details (page 4).

TI-RGB Array Commands

Prerequisite: Use the Send "Connect RGB" Command First

The "CONNECT RGB" command needs to be used first when using the TI-RGB Array. The "CONNECT RGB" command configures the TI-Innovator™ Hub software to work with the TI-RGB Array.

It establishes the connections to the various led binary slots on the TI-RGB Array – 0 through 15 RGB LED. It also clears the various counters and sensor values.

For additional commands see: education.ti.com/eguide

CONNECT RGB

Command:	CONNECT RGB
Command Syntax:	CONNECT RGB
Code Sample:	Send "CONNECT RGB"
Range:	N/A
Describe:	The "CONNECT RGB" command configures the TI-Innovator™ Hub software to work with the TI-RGB Array.
Result:	Connects the TI-RGB Array to the TI-Innovator™ Hub. The TI-RGB Array is now ready to be programmed
Type or Addressable Component:	All components of the TI-RGB Array. See Also: Commands to use with TI-RGB Array

Command:	CONNECT RGB AS LAMP
Command Syntax:	CONNECT RGB AS LAMP
Code Sample:	Send "CONNECT RGB AS LAMP"
Range:	N/A
Describe:	This command will enable the "high brightness" mode of the TI-RGB Array as long as an external power source (like the USB battery) is connected to the PWR port. Note: "AS LAMP" will need to be typed in.

Command:	CONNECT RGB AS LAMP
Result:	The TI-RGB Array is now configured to be in high-brightness mode. If the external power is not connected, the “ AS LAMP ” has no effect – i.e. the brightness will be at the default level. Also note, an error will be indicated by a beep tone.
Type or Addressable Component:	All components of the TI-RGB Array. See Also: Commands to use with TI-RGB Array

SET RGB

Command:	SET RGB n r g b
Command Syntax:	SET RGB n r g b SET RGB eval(n) r g b
Code Sample:	Send "SET RGB 1 255 0 255"
Range:	0-15 for 'n', 0-255 for r,g,b
Describe:	The SET RGB command controls the brightness and color of each RGB LED in the TI-RGB Array
Result:	The specific LED lights up with the specified color
Type or Addressable Component:	All components of the TI-RGB Array See Also: Commands to use with TI-RGB Array See Also: SET RGB ALL

SET RGB [n1 n2 n3...] r g b

Command:	SET RGB [n1 n2 n3...] r g b
Command Syntax:	SET RGB [n1 n2 n3...] r g b
Range:	A max of 16 LEDs can be specified.
Code Sample:	<pre>SET RGB [1 3 5 7] 200 0 200</pre> <p>Sets LEDs #1, 3, 5 & 7 to purple (red + blue).</p> <p>Note: If using eval() with a variable for the LED number, make sure there's a preceding space before the 'eval()'.</p> <pre>SET RGB [eval(i) eval(i+1)] 255 0 255</pre>
Describe:	Set the LEDs specified by their numbers to the specified color.

Command:	SET RGB [n1 n2 n3...] r g b
Result:	
Type or Addressable Component:	All components of the TI-RGB Array.

SET RGB PATTERN nnnn r g b

Command:	SET RGB PATTERN nnnn r g b
Command Syntax:	SET RGB PATTERN nnnn r g b nnnn – can be a decimal or a hexadecimal number.
Range:	nnnn – 0 to 65535
Code Sample:	<pre>SET RGB PATTERN 100 255 0 255</pre> <p>Display the number 100 in binary form on the RGB array and set the color of the LEDs to purple.</p> <pre>SET RGB PATTERN 0X100 255 0 0</pre> <p>Display the hexadecimal number 100 (equal to 256 in decimal) in binary form on the RGB array and set the color of the LEDs to red.</p>
Describe:	Display the pattern indicated by the number using the specified color.
Result:	
Type or Addressable Component:	All components of the TI-RGB Array.

SET RGB ALL

Command:	SET RGB ALL r g b
Command Syntax:	SET RGB ALL r g b
Code Sample:	<pre>SET RGB ALL 255 0 255</pre>
	<pre>SET RGB ALL 255 0 0</pre>
	<pre>SET RGB ALL eval(R) eval(G) eval(B)</pre>

Command:	SET RGB ALL r g b
	SET RGB ALL 0 0 0
Range:	
Describe:	To control all the LEDs in a single command use: SET RGB ALL r g b
Result:	Control all LEDs in a single command
Type or Addressable Component:	All components of the TI-RGB Array

READ RGB

Command:	READ RGB
Command Syntax:	Send "READ RGB"
Code Sample:	Send "READ RGB" Get c
Range:	
Describe:	Returns the value of the current consumed by the TI-RGB Array in mA
Result:	
Type or Addressable Component:	All components of the TI-RGB Array See Also: New Commands to use with TI-RGB Array

General Precautions

TI-RGB Array

- Do not expose the TI-RGB Array to temperatures above 140°F (60°C).
- Use only the Ribbon cable provided with the TI-RGB Array.
- When inserting the Ribbon cable into the TI-RGB Array connectors, make sure the red (dark) wire pin is inserted into the 5v hole.
- Use the TI-RGB Array no closer than 8 inches to your eyes.
- Rest your eyes periodically by focusing on an object at least 5 feet away.

TI-RGB Array Data Sheet

The TI-RGB Array Data Sheet include the following; a product name and number, a brief description, a product image, specifications, how the component connects to the TI-Innovator™ Hub, and Hub commands with simple code samples.

Topic Links

- [TI-RGB Array Data Sheet](#)
- [Breadboard Cable for TI-RGB Array](#)

TI-RGB Array Data Sheet



Title	TI-RGB Array
TI Item Name	STEMRGB/BK/A
Included in	TI-RGB Array
Quantity	1
Description	<p>Accessory to TI-Innovator™ Hub.</p> <ul style="list-style-type: none"> • 16 individually programmed RGB LEDs • M-M cable connects the Array to the Hub breadboard port <ul style="list-style-type: none"> – Red: 5V – power – Blue: BB5 – analog out – Yellow: BB2 – SPI signal – Black: GND – ground • Hub measures the LEDs’ current consumption

Category Accessory

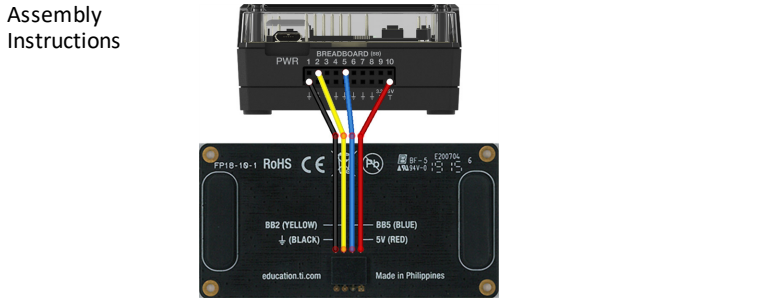

Precautions **See:** TI-RGB Array General Precautions

Specifications **See:** TI-RGB Array

HUB Commands

Sketch Object RGB Array

Command Syntax Send "CONNECT RGB"

Code Sample:	Desired Action	Code Sample
		Connect the TI-RGB Array to the TI-Innovator™ Hub. The TI-RGB Array is now ready to be programmed

Breadboard Cable for TI-RGB Array Data Sheet

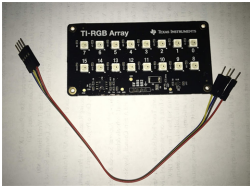

Title	Breadboard Cable for the TI-RGB Array
TI Item Name	STEMRGB/CA/A
Included in	TI-RGB Array
Quantity	1
Description	<ul style="list-style-type: none"> • M-M cable connects the Array to the Hub breadboard port <ul style="list-style-type: none"> – Red: 5V – power – Blue: BB5 – analog out – Yellow: BB2 – SPI signal – Black: GND – ground

Category Accessory

Hub Connection

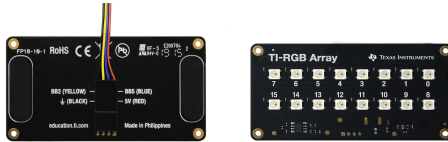

Assembly Instructions

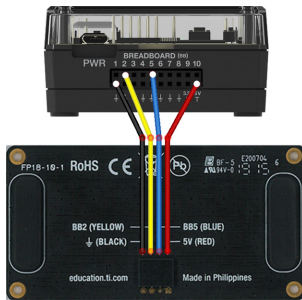

Precautions **See:** TI-RGB Array General Precautions

Specifications **See:** TI-RGB Array

Troubleshooting

This section describes some problems you may encounter and gives suggestions on how to resolve the problem.

If you need more assistance, contact TI-Cares.

TI-Innovator™ Hub Troubleshooting

TI CE Graphing Calculator or TI-Nspire™ CX handheld is not recognizing the TI-Innovator™ Hub, what do I do? I don't see the green LED when I connect my TI CE Graphing Calculator or TI-Nspire™ CX handheld to the TI-Innovator™ Hub?

- Make sure that the calculator is turned on.
- If you are using a USB Unit-to-Unit (Mini-A to Mini-B) cable to connect to a calculator, make sure to connect the "B" end of the cable to the "DATA  B" port at the bottom of the Hub. Reversing this cable prevents the Hub from receiving power.
- Make sure your calculator has the latest operating system.
- Make sure the end of the USB cable connected to the calculator is inserted completely.
- Unplug the USB cable from the TI-Innovator™ Hub wait 3 seconds and re-plug the USB cable.

TI-Nspire™ CX computer software is not recognizing the TI-Innovator™ Hub, what do I do?

- Make sure you are using the latest version of TI-Nspire™ CX software. The latest version installs a driver that allows the computer to recognize the TI-Innovator™ Hub.
- Make sure you are connecting to the TI-Innovator™ Hub using the "DATA  B" port on the TI-Innovator™ port
- Unplug the USB cable from the TI-Innovator™ Hub wait 3 seconds and re-plug the USB cable
- If you are not using the USB cable provided with the TI-Innovator™ Hub, the cable may be a power only USB cable rather than a power and data cable. Try a different USB cable.

How do I turn the Hub off?

- Turn off the host calculator or computer.
– OR –
- Disconnect the USB cable.

What does it mean when the Error LED blinks and the speaker makes a tone?

If the error LED blinks and the speaker makes a tone, there is an error in the commands being sent to the TI-Innovator™ Hub. Review the sample commands for the on-board, I/O modules, and breadboard components for ideas on how to modify your program.

Why is a driver for Silicon Labs CP210x installed on my computer when I plug in the TI-Innovator™ Hub?

The TI-Innovator™ Hub uses the Silicon Labs chip for its USB interface. The driver is needed for the desktop software to communicate with the hub. This will occur the first time you plug the TI-Innovator™ Hub into the computer.

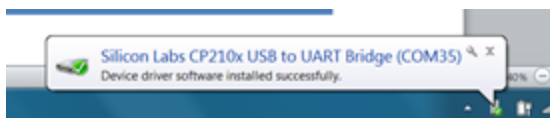

On-Board Hub Components Troubleshooting

My program is not working with the on-board component, how do I know the on-board component isn't broken?

- Download the test program and run this to test your on-board component.
- Make sure your program is using values that align with the ranges that the on-board components support
 - RGB: Range from 0 to 255 for level of intensity
 - Speaker: Range from 40 to 4000 Hz

Why does the on-board RGB go off every-time I play a tone on the speaker? Why can't I control the on-board RGB while the sound is being played?

The on-board COLOR/RGB commands and SOUND/SPEAKER commands can not be used at the same time. User programs should wait until the SOUND/SPEAKER command to complete before sending COLOR/RGB command to TI-Innovator™ Hub.

The on-board Light Brightness sensor is giving me changing readings even though my light source is not changing, why? My light brightness readings are toggling between max and min values when I expect a constant value?

LED light sources flicker at high speeds. While the human eye can not detect this flickering, the light brightness sensor does register this flicker and reports the values it is reading.

Ti-Innovator™ Rover Troubleshooting

My Rover not working as intended. Why?

- Check to make sure it is charged
- Make sure it is turned on.
- Make sure all cables are attached.
 - Make sure breadboard cable is in correct configuration (red wire on correct side)
 - Make sure all the breadboard pins are straight.
- Make sure you have latest sketch
- Make sure you have latest OS
- Try test program
- Do not have anything besides calculator on top of Rover.

My Rover is not moving, or is not moving correctly. Why?

- If using the pen holder, make sure that the pen is not inserted so far it is lifting up the Rover.
- Clean casters
- Use on smooth, flat surface for best results
- Check to see if orientation matches the expectations of your program.

The Rover did not draw the shape I expected. Why?

- Rover is not a precision drawing tool. You should expect a level of imprecision with specific shapes.
- When turning, Rover can have a +/- 0.5 degree variation. The greater number of segments (or turns) the more that variation can compound.
- Best surfaces to use Rover is a flat smooth surface (not carpet or tile)

What is the recommended Number of segments or turns to draw the expected shape?

There are two methods to draw shapes (or functions) with Rover.

They have different levels of precision and may result in different results even for the same general shape (e.g. octagon).

Method 1: Using FORWARD/BACKWARD/LEFT/RIGHT – these commands move Rover by the specified distance and angle. The angular movement may not be precise and depends on the surface as well as the presence of the marker.

Method 2: Using 'TO XY', 'TO POLAR' – these commands move Rover to specific coordinates with more precise turns. Even with these commands, small errors add up after multiple segments. Functions and shapes that use a large grid size and/or more than 18 segments may result in a drawing that does not match the expected shape.

My Rover is turning more or less than I expected. Why?

There are two different commands related to Rover turning

- RV LEFT/RV RIGHT commands: These commands will tell Rover to turn the specified angle relative to Rover's current position.
- RV TO ANGLE – This command will move to the specific angle on the unit circle

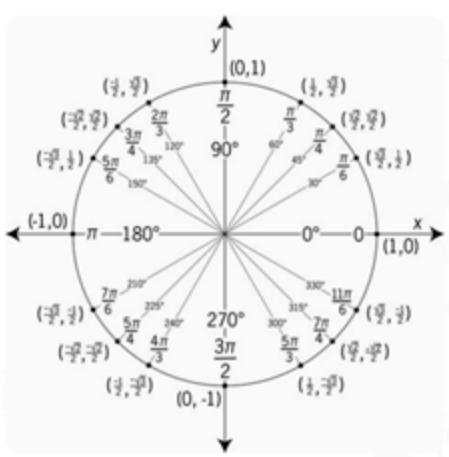

Examples:

RV LEFT 30

RV LEFT 45

Will result in Rover at an angle of 75 degrees

By comparison

RV TO ANGLE 30

RV TO ANGLE 45

Will result in Rover at an angle of 45 degrees

Make sure your program is using the turn command that matches your expectations of Rover's movement.

These commands use degrees as the default unit even if the calculator setting is in radians.

You can specify RADIANS or GRADS (gradians) for Rover turns in the command through the "Hub -> Rover (RV) -> RV Settings" menu

The Rover is not traveling the distance that I expected. Why?

Rover uses a default unit of 10 cm (~4 in).

So the command - RV FORWARD 1 – will cause Rover to move forward by 10 cm

It is equivalent to the "RV FORWARD 1 UNITS" and "RV FORWARD 0.1 M" commands

To move Rover for specific distances, you can use the 'M' setting to specify meters.

My marker is wobbly in the marker holder. Why?

The marker holder supports common thin markers or dry erase markers. The marker holder is designed to let gravity do the work to hold the marker in place. The tip of the marker will stay in the proper location, even if there is some movement at the other end of the marker.

What direction is Rover pointing when I start a program?

The default position of Rover is on the origin of a Cartesian grid point down the positive x-axis.

Original orientation is: position (0,0); heading 0 degrees (east – pointing toward the positive x-axis).

TO XY turns to the proper angle first, then moves straight to the point.

Example:

TO XY 1 1 turn 45 degrees to the left and then move $\sqrt{2}$ units (@ 10cm/unit = 14.14cm).

See also Rover>Setup>SET RV.POSITION

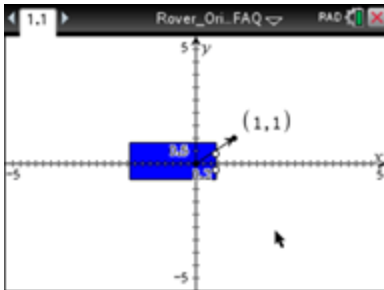

What are some cool XY or Polar commands to start with?

Table 1: Example 1:

```
Send "CONNECT RV"  
Send "RV TO XY 0 0"  
Send "RV TO XY 5 0"  
Send "RV TO XY 0 0"  
Send "RV TO XY 0 5"  
Send "RV TO XY 0 0"  
Send "RV TO XY 1 0"  
Send "RV TO XY 0 5"  
Send "RV TO XY 0 4"  
Send "RV TO XY 2 0"  
Send "RV TO XY 3 0"  
Send "RV TO XY 0 3"  
Send "RV TO XY 0 2"  
Send "RV TO XY 4 0"  
Send "RV TO XY 5 0"  
Send "RV TO XY 0 1"
```

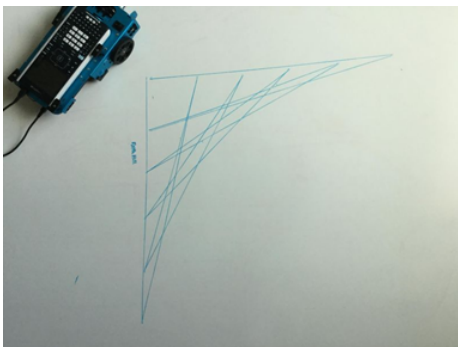

Why is my Rover program getting executed out of order?

The Rover commands fall into two categories:

1. Queued execution: All of the Rover motion commands – FORWARD, BACKWARD, LEFT, RIGHT, ANGLE – are queued on the TI-Innovator Hub. They may execute at a future time.
2. Immediate execution: Other commands – like the ones to read the sensors or set the RGB LED on the Rover – are executed immediately.

This means that certain statements in your program will execute before statements that appear earlier in the program especially if the latter commands are part of the queued family.

For example, in the program below, the RGB LED will turn RED before the Rover stops moving:

```
Send "SET RV.COLOR 255 0 255" – immediately executed  
Send "RV FORWARD 5" – queued command  
Send "RV LEFT 45" – queued command  
Send "RV RIGHT 90" – queued command  
Send "SET RV.COLOR 255 0 0" – immediately executed
```

Why is my Rover still running even though my calculator says ‘Done’?

This can happen if the commands are queued for later execution. The calculator says ‘Done’ because the program is done sending all the commands to the TI-Innovator Hub. The Hub will execute the commands to control the Rover even though the calculator program is complete.

I am showing no battery power when I plug in my Rover. Why?

While typically the battery charging status is shown immediately, it can take a minute for the battery status to show.

My Rover stopped working and will not turn back on. What should I do?

Charge the Rover for a couple of a couple minutes and wait for the battery status to display.

I turn the Rover off, but the program is still running, or items on Rover are still working. Why?

To completely disable the Rover, please turn the power switch to OFF and disconnect the USB cable from the graphing calculator.

Why does my Rover not travel in a straight line?

This can happen if the two motors do not have similar internal calibration. We are aware of this issue and are working on a solution via an update to the Hub sketch.

My graphing calculator is not fitting on the Rover.

Make sure you are using the correct orientation of the tabs. The tabs have ‘CE’ and ‘CX’ engravings to fit the TI84Plus CE family and the TI-Nspire CX family of calculators respectively.

My built-in sensor isn’t working? Does not give expected results or provides no data

Reference the test programs.

Looking for loose connections.

My student unplugged all the cables, what do I do?

Please refer to the wiring diagram below for reference.

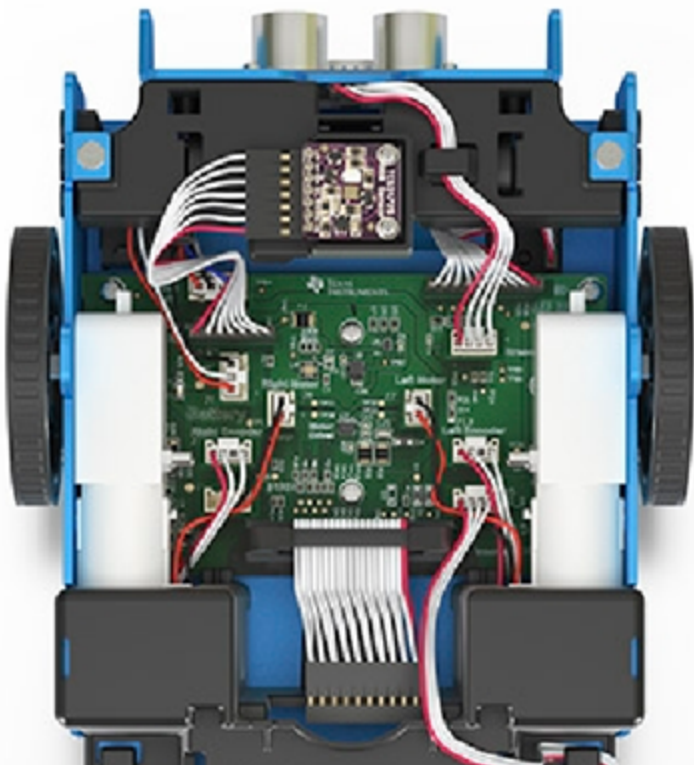

My Rover is moving slower, or turning oddly?

- Check the caster for debris
- Use compressed air to clean out.
- The tires may have come off. Check to make sure they are completely seated on the wheel.
- Smooth flat surface is recommended.

My tires came off

- How to check to make sure they are fully seated on the wheel.

My breadboard pins look bent? Can I still use?

Please re-align the pins in the original configuration before attaching to the Hub.

What do the commands TO XY and TO POLAR do? When I use them nothing happens with my Rover.

These commands will be implemented in a future release of the Hub sketch.

How can I get started? See what Rover can do?

- Demo: Programs to do stuff. Take it for a test drive.
 - Test Programs: try one component at a time. Make sure they work.
-

I/O Module Troubleshooting

My White LED I/O Module is not working what should I do?

The following troubleshooting steps will help determine if there is something wrong with the white LED I/O module.

- Ensure that the LED is properly inserted in the socket.
- Insert LED into socket - longer leg (lead) is positive (anode). If both leads are of equal length, the lead adjacent to the flat edge on LED casing is the negative (cathode) lead.
- Download the test program and run this to test your white LED module component.
- Ensure that you have connected the I/O module into correct port required by the program

My Analog Light Sensor I/O Module is not working what should I do?

The following troubleshooting steps will help determine if there is something wrong with the analog light sensor I/O module.

- Download the test program and run this to test your analog light sensor I/O module component.
- Ensure that you have connected the I/O module into correct port required by the program

My Vibration Motor I/O Module is not working what should I do?

The following troubleshooting steps will help determine if there is something wrong with the vibration motor I/O module.

- Download the test program and run this to test your vibration motor I/O module component.
- Ensure that you have connected the I/O module into correct port required by the program.

My Servo Motor I/O Module is not working what should I do?

The following troubleshooting steps will help determine if there is something wrong with the servo motor I/O module.

- Download the test program and run this to test your servo motor I/O module component.
- Ensure that you have connected the I/O module into OUT3 and that the program you are using is calling OUT3.

- The servo motor requires the TI-Innovator™ Hub to have external power. The **PWR** connector on the Hub lets you connect an auxiliary power source. You can use the TI Wall Charger or the External Battery. External power is required if the TI-Innovator™ Hub is being used with a graphing calculator or being used with the TI-Nspire™ CX computer software.
- Overtime the servo motor may need to be recalibrated. Steps to recalibrate:
 - Connect External Power to TI- Innovator HUB
 - Connect Servo Motor to OUT3
 - Send the Command "CONNECT SERVO 1 TO OUT3"
 - Send the Command "SET SERVO 1 CW 0 TIME 100" (Sets speed to zero, time value can be increased if needed)
 - If the Servo does not move, then it's already calibrated, If the servo is moving, use a screwdriver to move the potentiometer in the back of the motor until it stops.

My Ultrasonic Ranger I/O Module is not working what should I do?

The following troubleshooting steps will help determine if there is something wrong with the ultrasonic ranger I/O module.

- Download the test program and run this to test your ultrasonic ranger I/O module component.
- Ensure that you have connected the I/O module into correct port required by the program.

The on-board light brightness sensor and the analog light sensor I/O module give slightly different readings why?

The position of the sensor built-in to the TI-Innovator™ Hub can cause slightly different reading that those of the Analog Light Sensor.

TI-SensorLink Troubleshooting

- TI-SensorLink is **not** a data collection solution. USB connected probes or Lab Cradle remains a superior solution for pure data collection and analysis.
- The Hub commands for the TI-SensorLink with the Vernier analog sensors are currently **not** part of the Hub App (CE family) or the Hub menu (TI-Nspire™ CX).
- The new commands and keywords will either need to be typed in OR copied from an existing program. Please note that any typographical errors in the keywords will result in an error indication in the sketch.

Programming with TI-Basic Troubleshooting

Why does my program give me a syntax error?

- If you have pasted code from an external source or text editor, it might contain "curly" quotation marks ("...") in places that require straight quotes ("..."). You may need to replace some or all of the curly quotes.

- The syntax rules are slightly different between the TI CE Graphing Calculator and TI-Nspire™ CX technology. Code originally created for one platform may need to be modified to work on the other.
- On the TI CE Graphing Calculator, make sure you don't have a space character at the end of a line of code. To find these trailing spaces in a line, move the cursor to the line and press the [2nd] and then right arrow key. Adjacent spaces in code can also cause a syntax error.

How do I stop a program that becomes unresponsive?

- TI CE Graphing Calculator: Press the ON key.
- TI-Nspire™ CX Handheld: Hold down the Home/ON key and press ENTER repeatedly.
- Windows®: Hold down the F12 key and press Enter repeatedly.
- Mac®: Hold down the F5 key and press Enter repeatedly.

TI-SmartView CE is not showing the Hub commands in the programming menu?

Make sure you are using the latest version of TI-SmartView CE software, version 5.2. This version installs the 'Hub' app that includes the programming commands for the TI-Innovator™ Hub.

TI Connect™ CE software is not showing the Hub commands, why?

The TI-Innovator™ Hub commands have been added to the TI Connect™ CE software. Update your software to the latest version.

My program doesn't have any syntax errors but the error LED is showing an error?

The error LED will blink if there is an error in the command structure and the sketch is unable to process the commands. Review the sample commands for the on-board, I/O modules, and breadboard components for ideas on how to modify your program.

TI-Innovator™ Sketch Troubleshooting

Why do I get an error when I try to update the TI-Innovator™ Sketch?

- For sketch updating, make sure you are using the USB Standard A to Micro cable, not the USB Standard A to Mini-B cable. Connect the micro end of the cable to the PWR connector at the top of the Hub.

My TI-Innovator™ Hub is showing it gets power but will not talk to the update tool.

- This could be a cable issue. Some USB cables are only for power, not for data.
- Make sure you use the cable that comes with the TI-Innovator™ Hub.

Do I need admin privileges on my computer to upgrade the sketch?

Yes.

External Battery Troubleshooting

My external battery doesn't seem to be providing power to the TI-Innovator™ Hub.

- Press the On/Off button to ensure the battery is on. The external battery will turn itself off in 3 minutes if it is not connected to the TI-Innovator™ Hub.
 - Insure that the external battery has a charge. Press the On/Off button. If the LED lights do not light up the external battery needs to be charged.
-

TI-Innovator™ Technology General Precautions

This section describes suggested general precautions for all TI-Innovator Technology.

If you need more assistance, contact TI-Cares.

TI-Innovator™ Hub

- Do not expose the Hub to temperatures above 140°F (60°C).
- Do not disassemble or mistreat the Hub.
- Do not chain together multiple Hubs through the I/O ports or the Breadboard Connector.
- Use only the USB cables provided with the Hub.
- Use only the TI provided power supplies:
 - TI Wall Charger included with the TI-Innovator™ Hub
 - Optional External Battery Pack
 - 4AA battery holder included in the TI-Innovator™ Breadboard Pack
- Ensure that the components receiving power from the Hub do not exceed the Hub's 1-amp power limit.
- Avoid using the Hub to control AC electricity.

Breadboard Connector on the Hub

- Do not insert the leads of LEDs and other components directly into the Hub's Breadboard Connector. Assemble the components on the breadboard and use the provided jumper cables to connect the breadboard to the Hub.
 - Do not connect the 5V receptacle pin on the Hub's Breadboard Connector to any of the other pins, especially the ground pins. Doing so could damage the Hub.
 - Connecting the top row of receptacle pins (BB1-10) to the bottom row (grounding and power pins) is not recommended.
 - No pin on the Hub's Breadboard Connector can sink or source greater than 4 mA.
-

TI-Innovator™ Rover

- Do not expose the Rover to temperatures above 140°F (60°C).
 - Do not disassemble or mistreat the Rover.
 - Do not put anything heavier than 1 Kg or 2.2 lbs on the Rover platform.
 - Use only the USB cables provided with the TI-Innovator™ Hub.
 - Use only the Ribbon cables provided with the Rover.
 - Use only the TI provided wall charger included with the Hub.
-

- The front-mounted Ultrasonic Ranger will detect objects within 4 meters of the Rover. For best results make sure the object's surface is bigger than a folder. If used to detect small objects, such as a cup, place the Rover within 1 meter of the object.
 - For best results, leave the Slide Case off of your graphing calculator.
 - For best performance, use Rover on the floor, not on tables. Damage may occur from Rover falling off a table.
 - For best performance, use Rover on a hard surface. Carpet may cause the Rover wheels to catch or drag.
 - Do not turn the Holder pegs on the Calculator Platform without lifting them first. They could break.
 - Do not use the marker as a lever to pull or push the Rover.
 - Do not unscrew the case enclosure on the bottom of the Rover. Encoders have sharp edges that should not be exposed.
 - Do not move Rover after executing a program. The internal gyroscope may unintentionally try to get the Rover back on track using the initial location.
 - When inserting the Breadboard Ribbon Cable into the Hub Breadboard Connector, it is critical that you insert the cable correctly. Make sure the red (dark) wire pin is inserted into the 5v hole on the Hub's Breadboard Connector.
-

I/O Modules Precautions

- Use the correct Input or Output port as required for each module.
 - Vibration Motor – supported on **OUT 1**, **OUT 2**, and **OUT 3**.
 - Servo Motor – use **OUT 3** only.
 - White LED – supported on **OUT 1**, **OUT 2**, and **OUT 3**.
 - Analog Light Sensor – supported on **IN 1**, **IN 2**, and **IN 3**.
 - Ultrasonic Ranger – supported on **IN 1**, **IN 2**.
- Use an Auxiliary Power Source for modules that require more than 50 mA, including:
 - Vibration Motor
 - Servo Motor
- Do not hold the Servo Motor's shaft while it is rotating. Also, do not rotate the Servo Motor by hand.
- White LED:
 - Do not bend the leads repeatedly; this will weaken the wires and may cause them to break.
 - The LED requires the correct polarity when inserted into its socket. For details, refer to the instructions for assembling the LED in the TI-Innovator™ Technology eGuide (page ii).

- The LED requires the correct polarity when inserted into its socket. For details, refer to the instructions for assembling the LED (page 281).
 - No I/O module can sink or source greater than 4 mA.
-

Breadboard Precautions

- Do not connect the positive and negative leads of a power source to the same group of 5 pins on the breadboard. Doing so could damage the breadboard and the power source.
 - Observe the correct polarity:
 - When connecting the breadboard to the Hub.
 - When connecting components that are sensitive to polarity, such as LEDs and the TTL Power MOSFET.
-

TI-SensorLink Adapter and Vernier Sensor Precautions

TI-SensorLink

- TI-SensorLink is **not** a data collection solution. USB connected probes or Lab Cradle remains a superior solution for pure data collection and analysis.
- The Hub commands for the TI-SensorLink with the Vernier analog sensors are currently **not** part of the Hub App (CE family) or the Hub menu (TI-Nspire™ CX).
- The new commands and keywords will either need to be typed in OR copied from an existing program. Please note that any typographical errors in the keywords will result in an error indication in the sketch.

Vernier Sensors

- Gas Pressure Sensor - The Gas Pressure Sensor sensing element will be damaged with direct contact to liquid.
 - pH Sensor - Place the electrode in pH 4 or pH 7 buffer solution. It should never be stored in distilled water. If the electrode is inadvertently stored dry for a short period of time, immerse the tip in the pH 4 buffer/KCl storage solution for a minimum of 8 hours prior to use.
 - Stainless Steel Temperature Probe -
 - Twisting the cable. Sometimes students twist or crimp the wire near the handle of the sensor. Over time, this can cause the wires to come loose and make the sensor stop working.
 - Overheating the sensor. When used in chemistry labs, students will sometimes lay the sensor on a hot plate and effectively "cook" the unit.
 - The unit is not waterproof! Water can seep into the hilt of the sensor and damage the electronics. Only submerge the stainless steel portion the sensor into water when collecting data.
-

Frequently Asked Questions

This section includes some of the frequently asked questions we have received about the TI-Innovator™ Technology. Don't see your question? Send feedback to the eGuide team. hubeguide@list.ti.com

Topic Links

- [Product Compatibility Information](#)
- [TI LaunchPad™ Information](#)
- [General Activity Information](#)
- [General Power Information for TI-Innovator™ Hub](#)
 - [External Battery Information for TI-Innovator™ Hub](#)
 - [Rover Battery Information](#)

Product Compatibility Information

What TI products will work with the TI-Innovator™ Hub?

The TI-Innovator™ Hub is compatible with the following TI products. For best results always use the latest version of the TI-Innovator sketch and compatible products.

- TI CE Graphing Calculator
- TI-Nspire™ CX handheld
- TI-Nspire™ CX CAS handheld
- TI-Nspire™ CX computer software (Student, Teacher, and TI-Nspire™ CX Navigator™)

What programming language is compatible with the TI-Innovator™ Hub?

The TI-Innovator™ Hub can be programmed through the programming language **TI BASIC** on both the TI CE graphing calculators and TI-Nspire™ CX calculators. This programming language is used in several TI CE graphing calculators and is based on the BASIC (Beginner's All-purpose Symbolic Instruction Code) programming language. BASIC is a family of general-purpose, high-level programming languages whose design philosophy emphasizes ease of use.

In addition, with TI-Nspire™ CX technology you can use **LUA programming** which is a powerful, fast scripting language.

See Also: Hub Programming on TI CE Graphing Calculator for details.

See Also: Hub Programming on TI-Nspire™ CX Technology for details.

What sensors, actuators, etc. can I connect to the TI-Innovator™ Hub?

The TI-Innovator™ Hub has two types of connectors:

- Universal 4-pin connector that is compatible with an array of modules.
- Breadboard connector that can be connected to a breadboard for prototyping projects.

To easily get started, we have convenient kits that contain all the components you need to complete the activities. See the sections related to the I/O Module and Breadboard for details.

Can the TI-Nspire™ Lab Cradle with Vernier™ sensors be used while using the TI-Innovator™ Hub?

Yes, the TI-Nspire™ Lab Cradle can be used concurrently with the TI-Innovator™ Hub on

TI-Nspire™ CX Handheld or TI-Nspire™ CX software. To use both the TI-Innovator™ Hub and TI-Nspire™ Lab Cradle at the same time, they must be accessed via a LUA script.

Can I plug Vernier™ sensors directly into the TI-Innovator™ Hub?

The TI-Innovator™ Hub ports are not directly compatible with the Vernier™ sensors. The Vernier™ sensors can be connected to a TI-Nspire™ Lab Cradle. To use both the TI-Innovator™ Hub and TI-Nspire™ Lab Cradle at the same time, they must be accessed via a LUA script.

Can the TI-Nspire™ CX Navigator™ System be used while using the TI-Innovator™ Hub?

Yes, students can have their TI-Nspire™ CX handheld connected to the TI-Nspire™ CX Navigator™ system while using the TI-Innovator™ Hub. The teacher can use TI-Nspire™ CX Navigator™ functionality, including Live Presenter, Screen Capture, Quick Poll, etc. while students are using the TI-Innovator™ Hub.

Can TI Connect™ CE or TI-SmartView™ CE software communicate with the TI-Innovator™ Hub?

The TI-Innovator™ Hub cannot communicate directly with the TI Connect™ CE software or TI-SmartView™ CE software. However, you can use TI Connect™ CE software to write programs for use with the TI-Innovator™ Hub. TI-SmartView™ CE software is a great way to demo the programming steps to your students.

TI LaunchPad™ Information

What is a TI LaunchPad™ development kit?

TI LaunchPad kits are a range of microcontroller development kits (also called evaluation boards) from Texas Instruments. To learn more there is a lot of detail regarding the TI LaunchPad ecosystem at <https://www.ti.com/ww/en/launchpad/about.html>.

What TI LaunchPad™ kit is used in the TI-Innovator™ Hub?

The TI-Innovator™ Hub is powered by a MSP432P401 TI LaunchPad kit. More information on the MSP432P401 LaunchPad is at <https://www.ti.com/ww/en/launchpad/launchpads-msp430-msp-exp432p401r.html#tabs>.

Can I use the TI-Innovator™ Hub as a TI LaunchPad™ development kit?

While the TI-Innovator™ Hub can be used as TI LaunchPad™ Board, the TI-Innovator™ Hub was specifically designed to be used by students learning how to code, build, and explore using electronics. More information on TI LaunchPad can be found at <https://www.ti.com/ww/en/launchpad/about.html>.

What resources are available for the TI LaunchPad?

If you are interested in the TI LaunchPad ecosystem, you can find resources at <https://www.ti.com/ww/en/launchpad/about.html>.

How are development kits/engineering boards used by engineers in the real world?

Engineers use evaluation boards like the TI LaunchPad™ boards to prototype their designs and verify the suitability of a particular chip for their design. These boards allow engineers to try different approaches before finalizing their design. The boards also help the engineers measure other aspects of their designs, such as power consumption and speed of operations.

These evaluation boards are also used in universities to learn about microcontrollers, programming, and interfacing with sensors.

General Activity Information

What activities are available for the TI-Innovator™ Hub?

There are multiple activities available to use with the TI-Innovator™ Hub. Working with educators we have created activities around the following themes:

10 Minutes of Code for TI-Innovator™ Hub: Engage students in short activities that build understanding of math concepts, programming logic, and coding skills. Activities use the built-in RGB, LED, Speaker, and Light Brightness Sensor of the TI-Innovator™ Hub. Activities are available for the TI CE Family of Graphing Calculators and TI-Nspire™ CX technology.

10 Minutes of Code for TI-Innovator™ Rover: Continue learning to code with the TI-Innovator™ Rover. Build on your knowledge of programming the TI-Innovator™ Hub and write programs to control the TI-Innovator™ Rover. Learn the commands to make the Rover move and use its built-in ranger and color sensor. Activities will be available for the TI CE Family of Graphing Calculators and TI-Nspire™ CX technology.

Math and Science Classroom “Conversations” for TI-Innovator™ Rover: Ready-to-use programs for the TI CE Family of Graphing Calculators and TI-Nspire™ CX technology. These programs will include a usage guide for the teacher that will provide suggestions on how to implement the TI-Innovator™ Rover with the program(s) provided to explore concepts in the math and/or science classroom.

Science through Engineering Design: Rich, interactive lessons for middle grades students in life and physical science. Uses components provided in the TI-Innovator™ I/O Module Pack. Activities are available for TI-Nspire™ CX technology.

Path to STEM Projects: Design, build, test, refine. These sequential activities engage middle grade and high school students in engineering principles, providing students with the basic knowledge and skills required to synthesize new and unique STEM projects. These activities require the components provided in the TI-Innovator™ Breadboard Pack. Activities are available for the TI CE Family of Graphing Calculators and TI-Nspire™ CX technology.

Where can I download activities for the TI-Innovator™ Hub?

Activities for use with the TI-Innovator™ Hub can be found at the education.ti.com website, under the Activities tab at the top of each page. Direct links to each set of activities are as follows:

- 10 Minutes of Code with TI-Innovator™ Hub: education.ti.com/ticodes
- 10 Minutes of Code with TI-Innovator™ Rover: education.ti.com/ticodes

- Math and Science Classroom “Conversations” for TI-Innovator™ Rover:
- Science through Engineering Design:
<https://education.ti.com/en/tisciencenspired/us/stem>
- Path to STEM Projects: **TBD**

When will the activities be available?

The activities for the TI-Innovator™ Hub are now available. Activities for the TI-Innovator™ Rover will be available in Fall 2017.

General Power Information for TI-Innovator™ Hub

How is the TI-Innovator™ Hub powered?

The TI-Innovator™ Hub is powered by the batteries in the TI CE graphing calculator or the TI-Nspire™ CX handheld. In certain activities with high-powered devices such as servo motors, you may need to use an auxiliary power source – either the TI Wall Adapter or External Battery.

How does the TI-Innovator™ Hub affect the TI CE Graphing Calculator or TI-Nspire™ CX battery life?

The TI-Innovator™ Hub has a minimal impact on the battery of the TI CE graphing calculator or TI-Nspire™ CX graphing calculators.

When do I need to use the external power?

When using the Input and Output ports:

Certain I/O Modules require external power, as they use the 5V (OUT3 or IN3) ports on the TI-Innovator™ Hub. See the I/O Module section for details.

When using the Breadboard connector:

A circuit that is powered from the 5V output of the breadboard connector will require external power.

What options are available for external power?

You can use the TI Wall Adapter or the External Battery for additional power. The TI Wall Adapter comes with the TI-Innovator™ Hub and is the same wall charger that is provided with the TI CE graphing calculator and TI-Nspire™ CX calculators. The External Battery is sold separately as an accessory for the TI-Innovator™ Hub.

Can I use a different battery/power supply with the TI-Innovator™ Hub?

You should only use the battery and power supply provided by TI to ensure safe operation.

External Battery Information for TI-Innovator™ Hub

What is the external battery?

The External Battery provides additional power for those components that require more power than can be provided via the TI graphing calculator. This battery (Model # MP-3000) was selected to meet TI-Innovator™ component power needs.

How do you use the External Battery with the TI-Innovator™ Hub?

Using the Standard-A to Micro-B USB cable provided with the TI-Innovator™ Hub, the external battery should be connected to the PWR USB port on the TI-Innovator™ Hub. The external battery has an On/Off switch that must be turned on to provide power the TI-Innovator™ Hub.

How long will the battery last on a full charge?

The battery life will depend on the components attached to the TI-Innovator™ Hub. For example, the Servo Motor Module that is used with the Science through Engineering Design activities can run for 8 hours of continuous use using the external battery. Other components could last longer or drain the battery more rapidly.

What is the expected lifetime of the battery?

As lithium-ion batteries age, they lose capacity. When properly maintained and under normal usage, batteries are expected to last about three years.

How do you recharge the battery?

The External Battery can be recharged using the TI Wall Adapter (included with the TI-Innovator™ Hub) or the USB cable that came with the TI-Innovator Hub plugged into a computer USB port.

How do I know how charged my battery is?

When you turn the external battery on, the LED battery indicators on the External Battery will display the approximate battery charge (25%, 50%, 75%, and 100%). The LEDs turn themselves off after 10 seconds.

Can I use the External Battery with other products?

The External Battery was specifically tested for use with the TI-Innovator™ Hub.

Rover Battery Information

How long will the battery last on a full charge?

The battery will last 8 hours of continuous driving. Typical use is expected to include frequent breaks for programming. In that scenario, a full charge will last several days of uses.

What is the expected lifetime of the battery?

As lithium-ion batteries age, they lose capacity. When properly maintained and under normal usage, batteries are expected to last about 3 years.

How do you recharge the battery?

Connect a micro-USB cable to the PWR port on the right front side of the Rover. The other end of the cable can be connected to a PC or a TI wall charger.

How do I know how charged my battery is?

The four battery level LEDs shows the battery capacity. When all four LEDs are solid green, the Rover battery is fully charged.

General Information

Online Help

education.ti.com/eguide

Select your country for more product information.

Contact TI Support

education.ti.com/ti-cares

Select your country for technical and other support resources.

Service and Warranty

education.ti.com/warranty

Select your country for information about the length and terms of the warranty or about product service.

Limited Warranty. This warranty does not affect your statutory rights.