



# TI-Nspire™ CX Navigator™ System Guidebook

Learn more about TI Technology through the online help at [education.ti.com/eguide](http://education.ti.com/eguide).

## ***Important Information***

Except as otherwise expressly stated in the License that accompanies a program, Texas Instruments makes no warranty, either express or implied, including but not limited to any implied warranties of merchantability and fitness for a particular purpose, regarding any programs or book materials and makes such materials available solely on an "as-is" basis. In no event shall Texas Instruments be liable to anyone for special, collateral, incidental, or consequential damages in connection with or arising out of the purchase or use of these materials, and the sole and exclusive liability of Texas Instruments, regardless of the form of action, shall not exceed the amount set forth in the license for the program. Moreover, Texas Instruments shall not be liable for any claim of any kind whatsoever against the use of these materials by any other party.

© 2023 Texas Instruments Incorporated

Adobe®, Apple®, Excel®, Mac®, Microsoft®, PowerPoint®, SMART® Notebook, Vernier DataQuest™, Vernier EasyLink®, Vernier EasyTemp®, Vernier Go!Link®, Vernier Go!Motion®, Vernier Go!Temp®, Windows®, and Windows® XP are trademarks of their respective owners.

Actual products may vary slightly from provided images.

## Contents

<b>Setting up the TI-Nspire™ CX Navigator™ System</b> .....	<b>1</b>
Before You Begin .....	2
Updating the Handheld Operating System .....	3
Connecting the TI-Nspire™ Navigator™ Access Point .....	4
Confirming Handheld OS Version .....	7
Naming the Class Network .....	8
Adding Wireless Clients to the Network .....	11
Connecting the Handhelds to the Wireless Adapters .....	15
Creating and Managing Your Teacher Account .....	16
Logging In to the TI-Nspire™ CX Navigator™ System from the Handheld .....	18
Storing the Wireless Adapters .....	20
Using TI-Nspire™ Network Manager .....	21
Troubleshooting .....	27
<b>Getting Started with TI-Nspire™ CX Premium Teacher Software</b> .....	<b>29</b>
Exploring the TI-Nspire™ CX Premium Teacher Software .....	29
Exploring Workspaces .....	30
Exploring the Status Bar .....	30
Changing Language .....	32
<b>Tracking and Reporting System Use</b> .....	<b>33</b>
Managing Session Logs .....	33
Packaging and Sending Session Logs .....	35
<b>Using the Content Workspace</b> .....	<b>37</b>
Exploring the Content Workspace .....	37
Exploring the Resources Pane .....	37
Using the Preview Pane .....	39
Accessing Computer Content .....	40
Using Shortcuts .....	42
Working with Links .....	43
Using Web Content .....	45
Sending Files to Class .....	48
<b>Working with Connected Handhelds</b> .....	<b>51</b>
Viewing Content on Connected Handhelds .....	51
Managing Files on a Connected Handheld .....	53
Sending Files to Handhelds .....	55
Preparing Handhelds Remotely .....	58
Checking for an OS Update .....	62
Installing an OS Update .....	63
Renaming Handhelds .....	66
Using Identify Selected to Locate Handhelds .....	66

<b>Using the Transfer Tool</b> .....	<b>67</b>
Transfer Tool Interface .....	67
Opening the Transfer Tool .....	69
Adding Files or Folders to the Transfer List .....	69
Removing Files or Folders from the Transfer List .....	71
Editing the Destination Folder .....	72
Deleting All Handheld Files and Folders .....	73
Starting a Transfer .....	74
Stopping File Transfers .....	75
Closing the Transfer Tool .....	75
<b>Using the Documents Workspace</b> .....	<b>76</b>
Exploring the Documents Workspace .....	76
Using the Documents Toolbox .....	76
Exploring Document Tools .....	77
Exploring the Page Sorter .....	77
Exploring the TI-SmartView™ Feature .....	78
Exploring Content Explorer .....	80
Exploring Utilities .....	82
Using the Work Area .....	83
Changing Document Settings .....	84
Changing Graphs & Geometry Settings .....	86
<b>Working with TI-Nspire™ Documents</b> .....	<b>88</b>
Creating a New TI-Nspire™ Document .....	88
Opening an Existing Document .....	89
Saving TI-Nspire™ Documents .....	90
Deleting Documents .....	91
Closing Documents .....	91
Formatting Text in Documents .....	91
Using Colors in Documents .....	92
Setting Page Size and Document Preview .....	93
Working with Multiple Documents .....	94
Working with Applications .....	95
Selecting and Moving Pages .....	98
Working with Problems and Pages .....	101
Printing Documents .....	103
Viewing Document Properties and Copyright Information .....	104
<b>Working with Lesson Bundles</b> .....	<b>106</b>
Creating a New Lesson Bundle .....	106
Adding Files to a Lesson Bundle .....	107
Opening a Lesson Bundle .....	109
Managing Files in a Lesson Bundle .....	110
Managing Lesson Bundles .....	112
Packaging Lesson Bundles .....	114
Emailing a Lesson Bundle .....	115

Sending Lesson Bundles to Connected Handhelds .....	116
<b>Capturing Screens .....</b>	<b>117</b>
Accessing Screen Capture .....	117
Using Capture Class .....	118
Setting Teacher Preferences for Capture Class .....	119
Setting View Options in Capture Class .....	120
Creating Stacks of Student Screens .....	123
Comparing Selected Screens .....	125
Using Make Presenter .....	126
Saving Screens When Using Capture Class .....	126
Printing Captured Screens .....	127
Using Capture Page .....	128
Using Capture Selected Handheld .....	129
Viewing Captured Screens .....	130
Saving Captured Pages and Screens .....	131
Copying and Pasting a Screen .....	132
<b>Working with Images .....</b>	<b>133</b>
Working with Images in the Software .....	133
<b>Using the Class Workspace .....</b>	<b>137</b>
Adding Classes .....	137
Adding Students to Classes .....	142
Removing Students from Classes .....	144
Updating Class Rosters .....	145
Managing Classes .....	147
Beginning and Ending a Class Session .....	149
Changing the Student View .....	150
Arranging the Seating Chart .....	151
Checking Student Login Status .....	152
Sorting Student Information .....	152
Changing the Classes Assigned to a Student .....	152
Changing Student Names and Identifiers .....	154
Moving Students to Another Class .....	155
Copying Students to Another Class .....	156
Exploring the Class Record .....	156
Sending Files to a Class .....	158
Collecting Files from Students .....	160
Managing Unprompted Actions .....	163
Saving Files to a Portfolio Record .....	164
Deleting Files from Class Folders .....	164
Checking the Status of File Transfers .....	165
Canceling File Transfers .....	166
Viewing File Properties .....	166
Resetting Student Passwords .....	167

<b>Using Live Presenter</b> .....	<b>170</b>
Hiding and Showing Student Names .....	170
Hiding and Showing the Presenter Handheld .....	171
Viewing Keypress History .....	172
Showing the Handheld Screen Only .....	173
Recording the Live Presentation .....	174
Stopping Live Presenter .....	175
<b>Using Question in the Teacher Software</b> .....	<b>176</b>
Understanding the Question Tools .....	176
Using the Teacher Tool Palette .....	177
Understanding the Configuration Tool .....	178
Formatting Text and Objects .....	179
Adding Images to Questions .....	180
Adding Questions .....	180
<b>Responding to Questions</b> .....	<b>195</b>
Understanding the Question Toolbar .....	195
Types of Questions .....	195
Responding to Quick Poll Questions .....	196
Submitting Responses .....	198
<b>Polling Students</b> .....	<b>199</b>
Opening the Quick Poll Tool .....	200
Sending a Quick Poll .....	202
Stopping Polls .....	203
Resending Polls .....	203
Sending Polls to Missing Students .....	204
Saving Polls .....	204
Viewing Poll Results .....	204
<b>Using the Review Workspace</b> .....	<b>206</b>
Using the Review Toolbox .....	206
Exploring the Data View Pane .....	211
Opening Documents for Review .....	214
Viewing Data .....	216
Changing the Aspect Ratio .....	217
Organizing Responses .....	218
Hiding and Showing Responses .....	223
Marking Responses as Correct or Incorrect .....	226
Adding Teacher Data .....	231
Saving to the Portfolio Workspace .....	234
Saving Data as a New Document .....	235
<b>Using the Portfolio Workspace</b> .....	<b>236</b>
Exploring the Assignments Pane .....	236
Exploring the Workspace Views .....	237

Saving an Item to the Portfolio Workspace .....	239
Importing an Item to the Portfolio Workspace .....	240
Editing Scores .....	241
Exporting Results .....	242
Sorting Information in the Portfolio Workspace .....	244
Opening a Portfolio Item in Another Workspace .....	244
Opening a Master Document .....	245
Adding a Master Document .....	245
Redistributing a Portfolio Item .....	246
Collecting Missing Files from Students .....	246
Sending Missing Files to Students .....	247
Renaming a Portfolio Item .....	247
Removing Columns from Portfolio .....	247
Removing Individual Files from Portfolio .....	248
Summary of File Type Options .....	248
<b>Widgets .....</b>	<b>250</b>
Creating a Widget .....	250
Adding a Widget .....	250
Saving a Widget .....	253
<b>Libraries .....</b>	<b>254</b>
Creating Libraries and Library Objects .....	254
Private and Public Library Objects .....	255
Using Library Objects .....	256
Creating Shortcuts to Library Objects .....	257
Included Libraries .....	257
Restoring an Included Library .....	257
<b>Using the TI-SmartView™ Emulator .....</b>	<b>259</b>
Opening the TI-SmartView™ Emulator .....	259
Choosing Display Options .....	260
Working with the Emulated Handheld .....	261
Using the Touchpad .....	262
Using Settings and Status .....	262
Changing TI-SmartView™ Options .....	263
Working with Documents .....	264
Using Screen Capture .....	264
<b>Regulatory Information .....</b>	<b>265</b>
USA FCC Information Concerning Radio Frequency Interference .....	265
Canadian IC Information .....	267
Australia Regulatory Compliance .....	269
Japan Regulatory Compliance .....	270
Korea Regulatory Compliance .....	271
China SRRCC CMIIT Identification .....	272
Taiwan Regulatory Compliance .....	273
Warning Statements .....	273

Important for Safe AC Adapter Operation .....	274
<b>General Information .....</b>	<b>277</b>
<b>Index .....</b>	<b>278</b>





# Setting up the TI-Nspire™ CX Navigator™ System

The TI-Nspire™ CX Navigator™ System provides the hardware and software tools needed to set up a wireless classroom network, which enables you to:

- Use **Quick Poll** to send polls to students, receive student responses, and review the poll results with students.
- Use **Screen Capture** to capture screens from student handhelds or computers automatically, or at specific time intervals.
- Use **Live Presenter** to display work as it is being performed on your handheld screen, or on a student handheld screen.
- Use the **Review Workspace** to collect and review student assignments, watch results in real time as students answer questions, and analyze data for the entire class or for individual students.

## About the Hardware

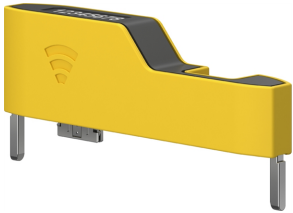
Depending on classroom requirements, your TI-Nspire™ Navigator™ System may include the following hardware, which is used to create a wireless communications network so that your computer can communicate with student handhelds:

Hardware Name	Image	Use
TI-Nspire™ Wireless Network Adapter	 A yellow, L-shaped wireless network adapter with a black top surface and two silver legs. A white Wi-Fi symbol is visible on the yellow side.	Attaches to the TI-Nspire™ CX and TI-Nspire™ CX CAS handhelds to enable wireless communication over a 2.4GHz band.
TI-Nspire™ CX Wireless Network Adapter – v2	 A yellow, L-shaped wireless network adapter, similar to the first one but with a black top surface and a white Wi-Fi symbol on the yellow side. The text "v2" is printed on the yellow side.	Attaches to the TI-Nspire™ CX and TI-Nspire™ CX CAS handhelds to enable wireless communication over a 2.4GHz or 5GHz band.
TI-Nspire™ Navigator™ access point	 A black, rectangular wireless access point with rounded corners. The text "TI-Nspire™ navigator access point" is printed on the top surface. There are two green indicator lights at the bottom left.	Connects to the teacher computer to provide a 2.4GHz wireless communication link.

Hardware Name	Image	Use
TI-Nspire™ CX Navigator™ access point		Connects to the teacher computer to provide either a 2.4GHz or 5GHz wireless communication link.

## Before You Begin

When you launch a new version of the TI-Nspire™ CX Premium Teacher Software for the first time with an Access Point attached or by selecting **Window > Enable TI Nspire CX Navigator**, the TI-Nspire™ CX Navigator™ System Startup wizard opens and guides you through the automated process to set up your wireless classroom. Before you begin the wireless set up process:

- Make sure you have installed and activated the TI-Nspire™ CX Premium Teacher Software on your computer.

**Note:** If you are using TI-Nspire™ wireless network adapters, you do not need to charge them. The wireless network adapters are powered by the handhelds.

- Disconnect the TI-Nspire™ Navigator™ access point or TI-Nspire™ CX Navigator™ access point from your computer.

## Automated System Startup

When you launch the software, the Startup wizard guides you through the steps needed to:

- Update all student and classroom handhelds to the latest operating system (OS) version. The OS on the handhelds must match the software version installed on your computer.

**Important!** When updating the OS, handhelds must be connected to the computer using a USB cable or TI-Nspire™ CX Docking Station.

- Name the class network.
- If required, select a channel for the access point.
- Add wireless clients to your network.
- Create a backup copy of the class network configuration.

## Updating the Handheld Operating System

When you install or update the TI-Nspire™ CX Premium Teacher Software with an Access Point attached or by selecting **Window > Enable TI Nspire CX Navigator**, the Startup dialog box opens when you launch the software for the first time. You **must** update all student and classroom handhelds to the latest operating system.

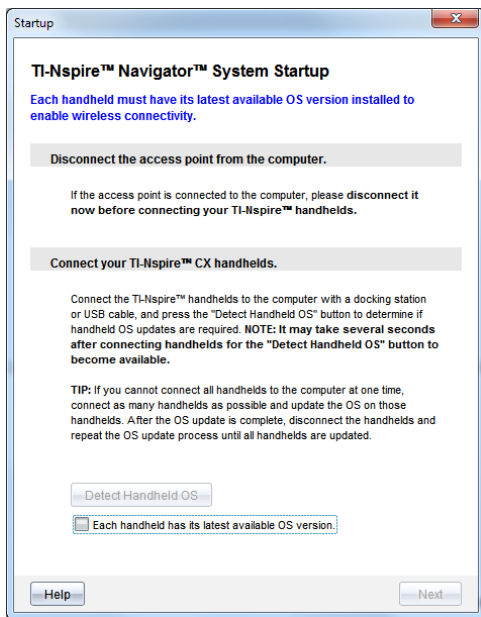

Complete the following steps to ensure all handhelds are updated.

1. Disconnect the access point if it is connected to your computer.
2. Connect the handhelds to the computer.

You must connect handhelds using a USB cable or connect multiple handhelds using the TI-Nspire™ docking station.

3. Click **Detect handheld OS**.
  - If the OS for all connected handhelds matches the software version, the Handheld OS Update dialog box is displayed informing you that all handhelds are up to date. Click **Close** to return to the Startup dialog box.
  - If the OS on the connected handhelds is not current, the Handheld OS Update Required dialog box is displayed. Click **Update OS**.

The Add to Transfer List dialog box opens.

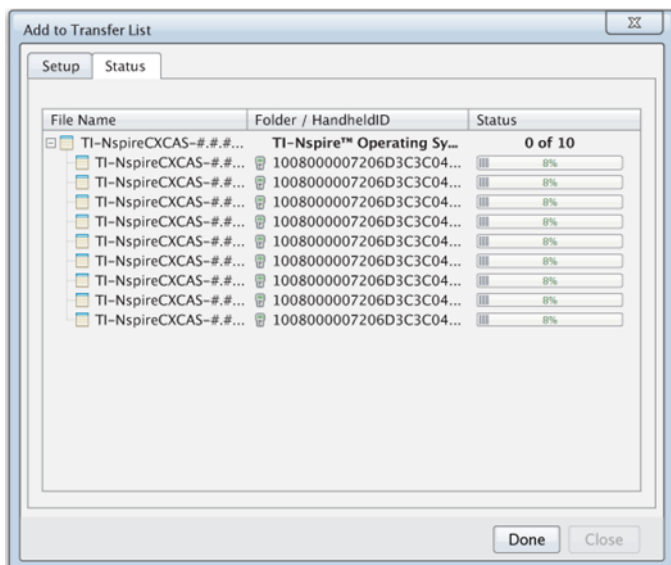

The matching OS files are transferred to the connected handhelds. You can update TI-Nspire™ CX handhelds and TI-Nspire™ CX II handhelds at the same time. If you cannot connect all handhelds at one time, connect as many as possible and update the OS. After the OS update is complete, disconnect the handhelds and repeat the OS update process until all handhelds are updated. The software will detect the OS needed and begin the transfer as you connect the handhelds.

- Click **Done** to stop the transfer process when all handhelds are updated.
    - The Add OS Transfer List closes.
    - The Start Up dialog box is displayed.
4. Select the **All handhelds are updated to OS version 6.0.3** check box.
  5. Click **Next**.

The Connect Access Point dialog box opens.

### **Connecting the TI-Nspire™ Navigator™ Access Point**

When the operating system update on all handhelds is complete, the next step in the system startup process is to connect the access point. When you connect the access point to your computer, it is powered on and ready to communicate with wireless network adapters.

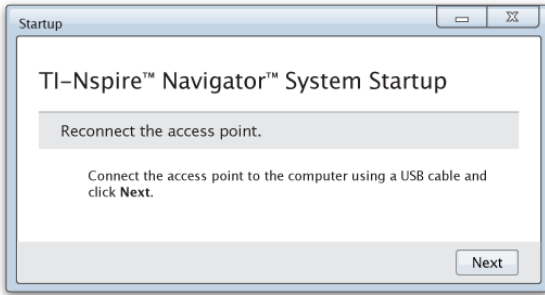

1. Connect the access point to the computer using a USB cable.
  - a) Connect the small end of the USB cable to the access point.

Connect the access point directly to your computer. Do not connect the access point to a USB hub or docking station.
  - b) Connect the other end of the cable to the USB port on your computer.
  - c) Make sure the access point power light is on. The power light indicates that the access point is receiving power from the computer. The signal light indicates wireless link activity.



*TI-Nspire™ Navigator™ access point*

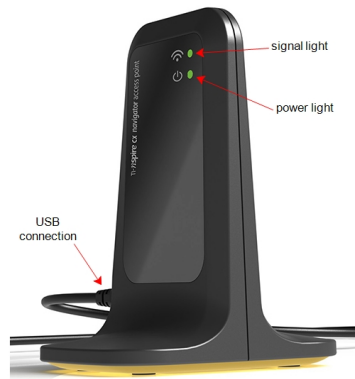

*TI-Nspire™ CX Navigator™ access point*

**Note:** If the software does not detect a connected access point within one minute, an error message is displayed. Close the error message, and then disconnect and reconnect the access point.

2. Click **Next**.

The software detects the access point type and checks the firmware version on the access point. If a newer firmware version is available, the software updates the firmware.

**Note:** It may take up to 60 seconds for the software to detect the access point.

**Important!** Do not stop the update process or disconnect the access point until the firmware update is complete.

When the update is complete, the software checks the access point for a configured classroom network.

- If a classroom network exists, the software reminds you that you can keep the current setup or make changes.

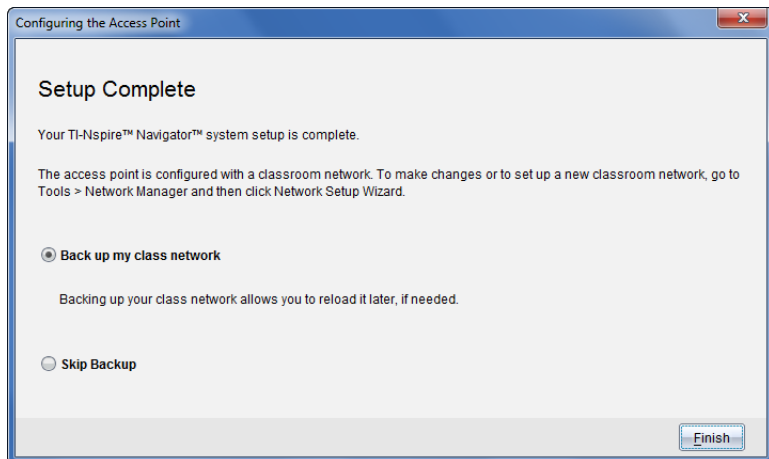

- If no classroom network exists, the software guides you through the Class Network Setup wizard.
3. Select **Back up my class network** to save a copy of your classroom network configuration.

The saved network information includes the list of wireless client IDs, the network name, and the channel and country selected on the access point.

Saving a network enables you to reload the configuration at a later time using the Network Manager. By default, the file is saved in the **My Documents/TI-Nspire/Navigator Network** folder.

To finish without saving a backup copy, select **Skip backup**.

4. Click **Finish** to complete the setup.

**Note:** You can set up a network at any time, or make edits to an existing network, by using the Network Manager.

## Troubleshooting

If the firmware update fails, the OS Warning dialog box opens.

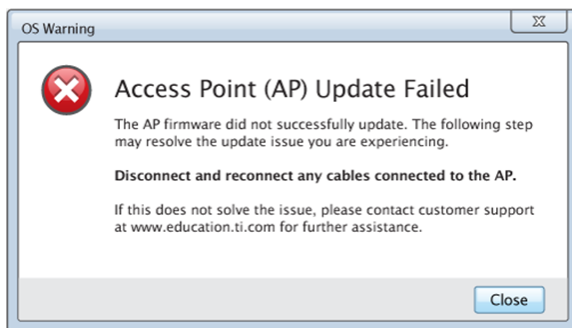

To resolve the problem, disconnect and reconnect any cables connected to the access point, and the software will automatically start the update process. If this does not resolve the issue, contact Customer Support.

### ***Confirming Handheld OS Version***

If you did not update handhelds during startup, the wizard asks you to confirm that classroom and student handhelds are updated to the latest OS version. The OS version on the handhelds must match the software version before you can set up the class network.

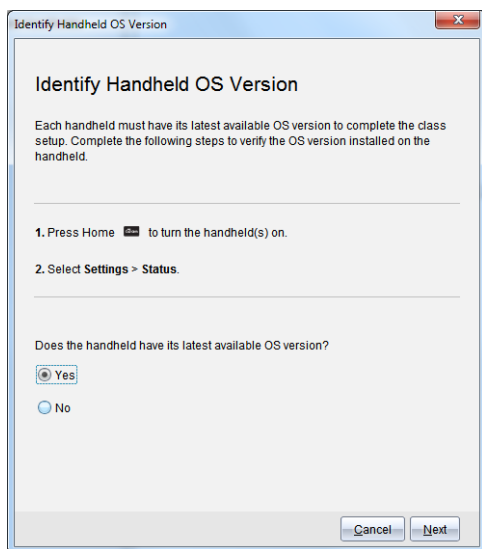

To check the OS version on a handheld,

1. Press **[Home icon]** to turn the handheld on.
2. Select **Settings > Status** to open the Handheld Status window.

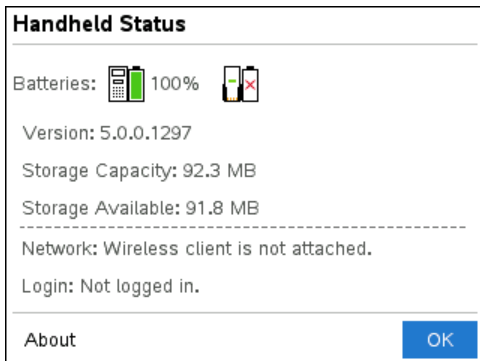

3. Make sure the OS on the handheld matches the software version on your computer.
  - If the OS version is current, select **Yes**.
  - If the OS version is not current select **No**.
4. Click **Next**.
  - If the OS version was not current, the Handheld OS Update Required dialog box is displayed. Click **Update OS** to open the Add OS Transfer Tool and update the handhelds.
  - If the OS version is current, the Class Network Name dialog box opens and you can continue the process to set up the class network.

### ***Naming the Class Network***

When the Class Network Name dialog box opens, complete the following steps to name your class network.



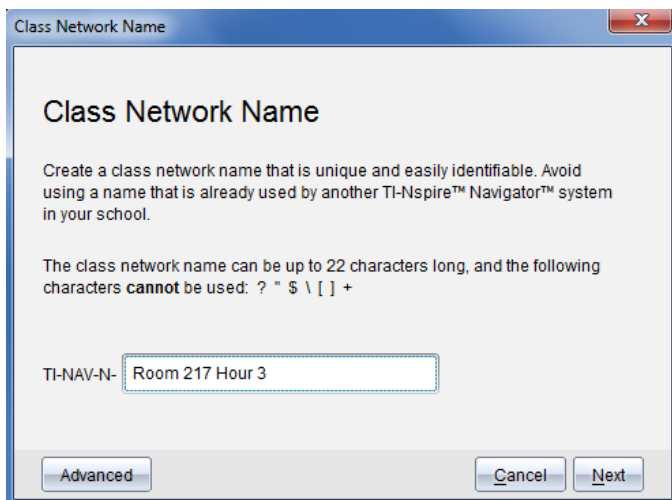

1. Type the name you want to assign to the class network in the TI-NAV-N field.  
Use a name that is unique, easy to remember, and easy for you to identify. The class network name can be up to 22 characters long. Names can consist of letters, numbers, and spaces; but cannot contain special characters such as ? " \$ \ ! [ ] +.
2. Click **Next** to configure the access point with no changes.  
— or —
3. Click **Advanced** to select a different band or operating channel.

- If the TI-Nspire™ Navigator™ access point  is connected, you can select a different operating channel.

- If the TI-Nspire™ CX Navigator™ access point  is connected, you can select either a 2.4GHz band or 5GHz band, and you can select a different operating channel.

**Note:** Operating channels available for selection are determined by the installed software version.

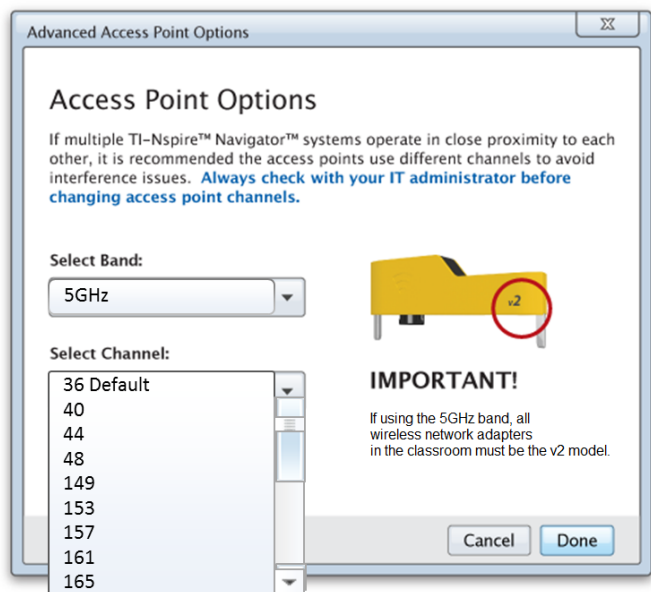

**Important!** If you are using the TI-Nspire™ CX Wireless Network Adapter – v2 adapters, you can select either the 2.4GHz or 5GHz band. If you have a mixture of wireless network adapters, you must select the 2.4GHz band.

4. Click **Done**.

The Configuring the Access Point dialog box opens and the software configures the access point and applies the class network name.

**Important!** Do not disconnect the access point while it is being configured.

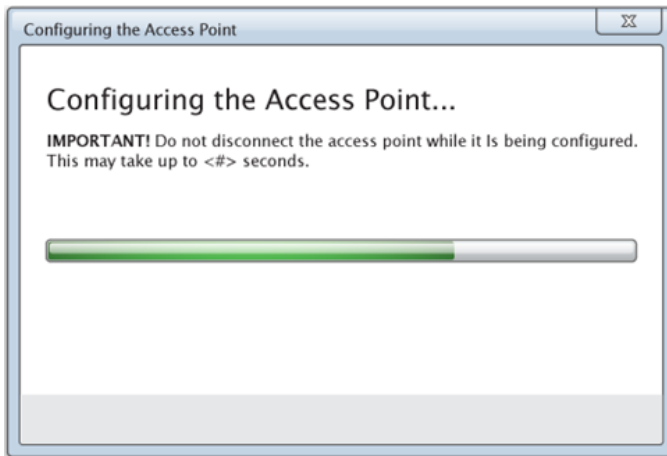

When the configuration process is complete, you can associate your wireless clients.

### ***Adding Wireless Clients to the Network***

After you assign a name to your class network and the access points are configured, you must associate your wireless clients with the network. How you complete this process depends on whether you have docking stations that enable you to work with multiple handhelds and wireless clients at one time.

- If you have a docking station, attach the adapters to the handhelds, and then insert the handhelds into a docking station that is connected to your computer.
- If you do not have a docking station, attach the wireless adapters to the handhelds.

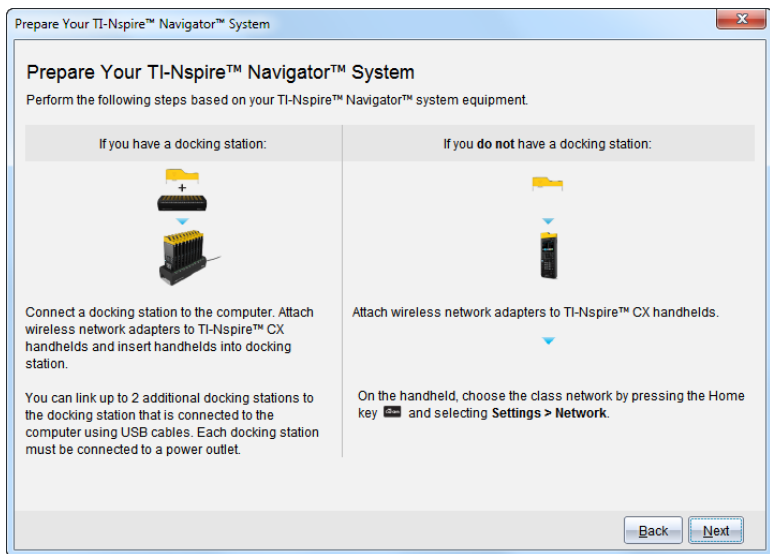

1. Follow the on-screen instructions to connect the handhelds to their wireless adapters and/or docking stations, and then click **Next**.

The Add Wireless Clients to Class Network dialog box opens.

The access point finds the available clients and lists them in the Available Clients box. It can take up to six minutes for the access point to find all available clients. Check the number of available clients to ensure all clients are listed.

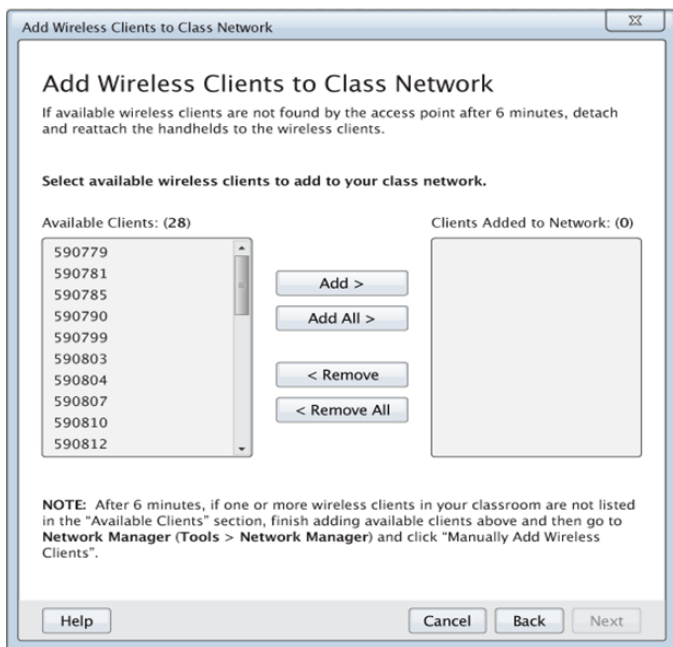

2. Follow steps **a**, **b**, and **c** on all TI-Nspire™ handhelds that are *not* inserted into a docking station.
  - a) Turn on each handheld.
  - b) From the Home screen of the handheld, select **Settings > Network**. The handheld lists the available networks that are within range.
  - c) Select the name that you assigned to your class network, and click **Connect**.
3. On the Add Wireless Clients to Class Network screen, select the wireless clients you want to add.
  - To add all available clients listed, click **Add All**.
  - To add specific clients, select one client ID at a time, and then click **Add**.

**Important!** Clients are not part of the class network until you complete this step to add them.

4. Click **Next** to associate the wireless clients with the classroom network.

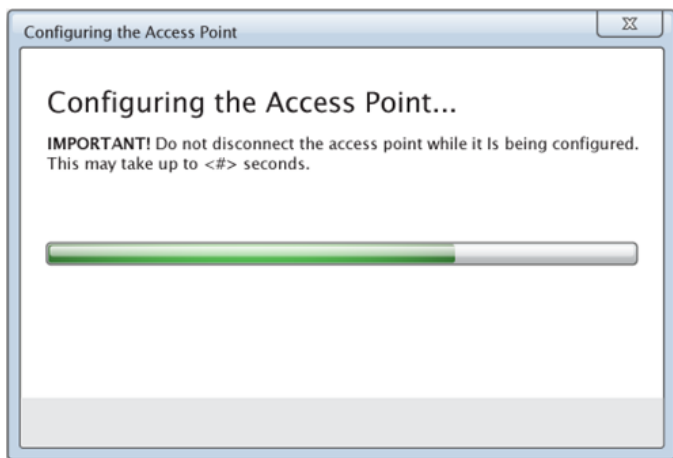

The software associates the attached wireless clients with the classroom network. When the process is complete, the Setup Complete dialog opens.

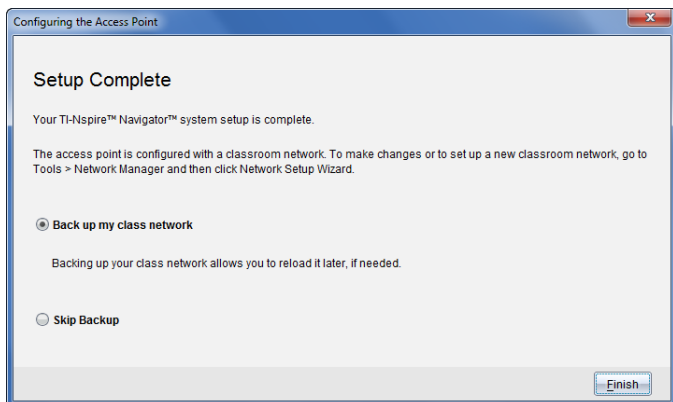

5. Select **Back up my class network** to save a copy of your classroom network configuration.

The saved network information includes the list of wireless client IDs, the network name, and the channel and country selected on the access point.

Saving a network enables you to reload the configuration at a later time using the Network Manager. By default, the file is saved in the **My Documents/TI-Nspire/Navigator Network** folder.

To finish without saving a backup copy, select **Skip backup**.

6. Click **Finish** to complete the setup.

**Note:** You can add more wireless adapters to the class network at a later time using the Network Manager.

## Connecting the Handhelds to the Wireless Adapters

The wireless network adapters work with the TI-Nspire™ CX handhelds. To connect the handheld to a wireless adapter, follow these steps.

1. Position the wireless adapter on top of the handheld so the connector on the adapter lines up with the connector on top of the handheld.

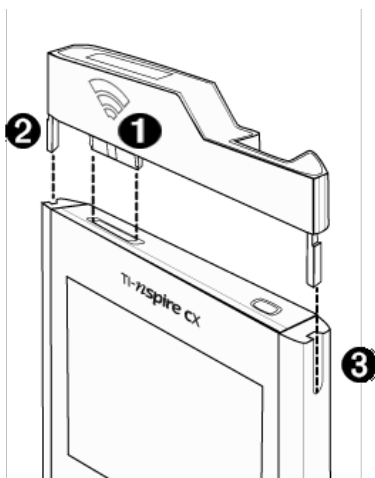

- 1 Connector
- 2 Guides for aligning with handheld
- 3 Grooves to align wireless adapter

2. Slide the adapter into position, making sure the guides on the sides of the adapter slide into the grooves on the sides of the handheld.
3. Firmly press the adapter into place.



## Creating and Managing Your Teacher Account

Create your teacher account in the Teacher Preferences section of the TI-Nspire™ CX Premium Teacher Software. A teacher account lets you log in to the TI-Nspire™ Navigator™ network from your handheld. After you create a teacher account, you can later change your password or your user name.

### Creating Your Teacher Account

1. Use the Workspace selector to choose the Class workspace.

2. Click **File > Settings > Teacher Preferences** .



The Teacher Preferences dialog box opens.

A screenshot of the 'Teacher Preferences' dialog box. The dialog has a blue title bar with 'Teacher Preferences' and a close button (X). It contains two main sections: 'Teacher Account' and 'Options'. In the 'Teacher Account' section, there are text boxes for 'Username:' and 'Password:', a 'Reset' button, and a checked checkbox for 'Add teacher to classroom view'. In the 'Options' section, there are two checkboxes: 'Randomize order in Screen Capture' (checked) and 'Individualize Teacher Handheld in Screen Capture' (unchecked). At the bottom are 'OK' and 'Cancel' buttons.

3. Type a username.
4. Type a password.
5. Select or clear the preference for the teacher icon to appear in the classroom view.

If you select this preference, the teacher icon will appear in the classroom view, and you will be included as a recipient in Send to Class, Collect from Class, and Delete from Class operations. The teacher handheld screen will be included in screen captures of the class.

6. Select or clear the options to randomize the order in Screen Capture, and to individualize the teacher handheld in Screen Capture.
  - **Randomize order in Screen Capture.** Selecting this option captures and displays student screens in a random order, not the order on the class listing. This enables students to concentrate on the assignment, not whose screen they are viewing.
  - **Individualize Teacher Handheld in Screen Capture.** Selecting this option shows the teacher's screen in the screen capture.
7. Click **OK**.



## Changing the Password of Your Teacher Account

1. Make sure you are not logged in to the TI-Nspire™ Navigator™ network on your handheld.
2. Click **File > Settings > Teacher Preferences** .

The Teacher Preferences dialog box opens.

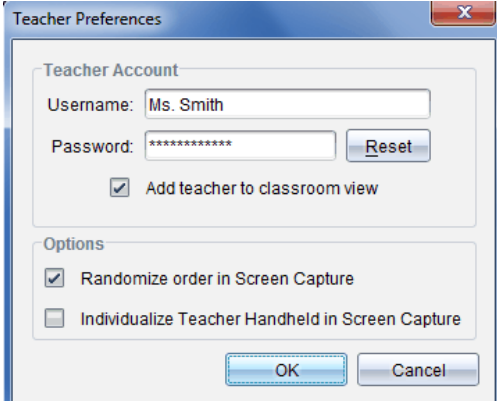

Teacher Preferences

Teacher Account

Username: Ms. Smith

Password: \*\*\*\*\* **Reset**

Add teacher to classroom view

Options

Randomize order in Screen Capture

Individualize Teacher Handheld in Screen Capture

**OK** **Cancel**

3. Click **Reset**.

TI-Nspire™ Premium Teacher software clears the current password.

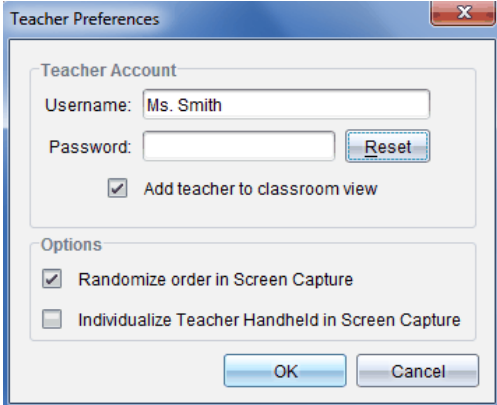

Teacher Preferences

Teacher Account

Username: Ms. Smith

Password:  **Reset**

Add teacher to classroom view

Options

Randomize order in Screen Capture

Individualize Teacher Handheld in Screen Capture

**OK** **Cancel**

4. Type a new password.
5. Click **OK**.

## Changing the User Name of Your Teacher Account

1. Make sure you are not logged in to the TI-Nspire™ Navigator™ network on your handheld.
2. Click **File > Settings > Teacher Preferences** .

The Teacher Preferences dialog box opens.

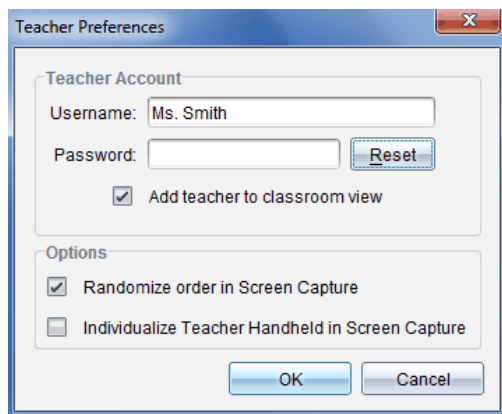

3. Enter a new user name.
4. Click **OK**.

## Logging In to the TI-Nspire™ CX Navigator™ System from the Handheld

The TI-Nspire™ CX Navigator™ classroom learning system uses both your computer and student handhelds. For you and your students to communicate using the TI-Nspire™ Navigator™ network, students must log in to the network from their handhelds.

**Note:** You do not have to log in to communicate with student handhelds; you can use the Transfer Tool to delete files or send files and operating systems to student handhelds. However, if you plan to participate from your handheld during the TI-Nspire™ Navigator™ class session, then you must log in to the TI-Nspire™ Navigator™ network from your handheld.

For more information on using a handheld, refer to the handheld guidebooks available at [education.ti.com/guides](http://education.ti.com/guides).

Before you log in, make sure these items are ready:

- You have created your teacher account in Teacher Preferences.
- You have started a class session on your computer.
- The TI-Nspire™ handheld is ready for login. (The  icon is blinking.)

Before your students log in, make sure you complete these items:

- Create student accounts.
- Provide students with the class network name, their user names and, if necessary, their passwords.

### Logging In to the TI-Nspire™ Navigator™ Network

1. To log in, do one of the following:

- From the Home screen of your TI-Nspire™ handheld, select **5:Settings > 5:Login**.
- From a screen other than the Home screen, press **[doc]** > **8:Login**.

The last network the wireless client was associated with appears on the handheld screen.

**Note:** If the handheld is connected to the computer with the USB cable, no network names appear on the screen, and you can continue logging in.

2. If the name of the network that appears is correct, continue with login. If the network is not correct, click **Network**.

The handheld screens displays all networks it has been connected to, and also displays other networks within range.

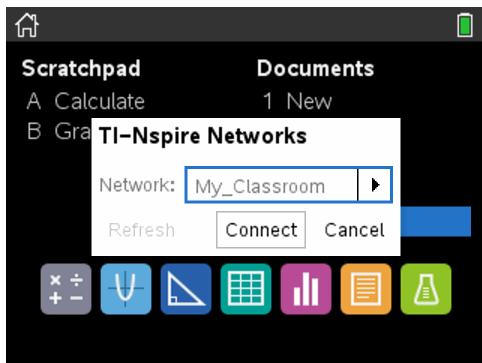

3. Select the network from the list, and then click **Connect**.

The login screen shows the connection status and displays the network name when the connection is successful.

4. Type your username and password.

5. Select **Login**.



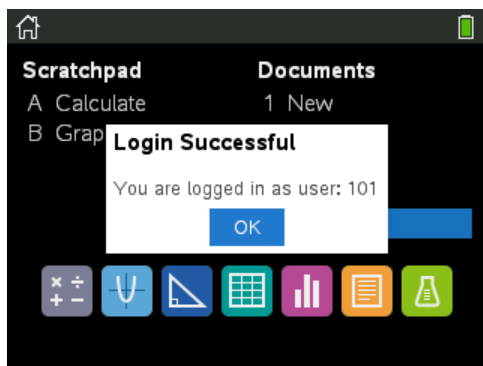

The Login Successful screen opens.



6. Click **OK**.

### TI-Nspire™ Handheld Login Status Icons

The icons on the TI-Nspire™ CX handheld screens indicate the communication status between the handheld and the access point, wireless adapter, or TI-Navigator™ network. The icons indicate status as follows.

Icon	Status	Meaning
No icon		If no icon appears on the handheld, the handheld is not searching for an access point. Unattach and reattach the wireless adapter.
	Blinking	The handheld is searching for an access point.
	Solid	The handheld has found an access point.
	Solid	The handheld is not communicating with the adapter. Remove the handheld from the adapter, wait for the icon to disappear, and then reattach the handheld to the adapter.
	Blinking	The handheld is connected to the network and is ready to login.
	Solid	The handheld is logged in to the network.

### Storing the Wireless Adapters

When you charge the handhelds overnight, you can leave the wireless network adapters attached to the handhelds before placing the handhelds in the TI-Nspire™ CX Docking Station. When you are ready to use the handhelds the next morning, the handheld should be fully charged, and the adapter is ready for use.

You can remove the wireless adapter from the handheld, and store the adapters in the adapter storage case overnight.

If you need to store the wireless adapters for more than two weeks, remove the wireless adapter from the handheld, and store the adapters in the adapter storage case. Place the storage case in a cool, dry place.

## Using TI-Nspire™ Network Manager

### Accessing the TI-Nspire™ Network Manager

- ▶ Click **Tools > Network Manager**.

The TI-Nspire™ Network Manager opens.

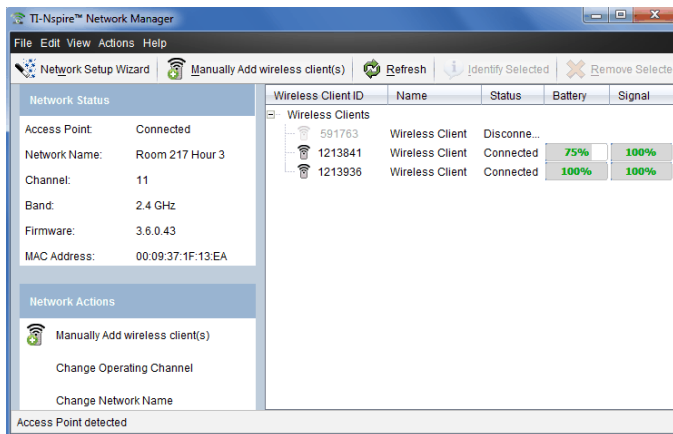

**Note:** Click  **Refresh** at any time to refresh the TI-Nspire™ Network Manager window.

### Opening the Network Setup Wizard

You can set up or edit a classroom network at any time using the Network Setup Wizard.

- ▶ In the TI-Nspire™ Network Manager window, click **Network Setup Wizard**.

The wizard guides you through the process of setting up a classroom network, including:

- Update all student and classroom handhelds to the latest operating system (OS) version. The OS on the handhelds must match the software version installed on your computer.
- Connect the access point and, if needed, update the access point firmware.
- Name the class network.
- If required, select a channel for the access point.
- Add wireless clients to your network.
- Create a backup copy of the class network configuration.

## Checking Network Status

The network status is shown in the side bar of TI-Nspire™ Network Manager window.

**Note:** If the sidebar is hidden, click **View > Sidebar**. Click **Refresh** to update the status if the Network Manager is already open.

Network Status	
Access Point:	Connected
Network Name:	Room 217 Hour 3
Channel:	11
Band:	2.4 GHz
Firmware:	3.6.0.43
MAC Address:	00:09:37:1F:13:EA

The network status shows the following information:

- **Access Point.** Shows whether the AP is connected or disconnected.
- **Network Name.** The name you gave the network when you set it up.
- **Channel.** The access point operating channel for the current network.
- **Band.** The selected communication link.
- **Firmware.** The version of the access point.
- **MAC Address.** The Media Access Control address that identifies the access point.

After you have set up the network, all of the adapters you added appear in the TI-Nspire™ Network Manager window. If the wireless adapter is charged and attached to a TI-Nspire™ handheld that is powered on, TI-Nspire™ Network Manager shows the status as connected. It may take up to 30 seconds to recognize the wireless client and

show its status as connected. The status window also displays the battery status and signal strength.

Wireless Client ID	Name	Status	Battery	Signal
Wireless Clients				
591763	Wireless Client	Disconnect..		
1213841	Wireless Client	Connected	75%	100%
1213936	Wireless Client	Connected	100%	100%

If the adapter is not connected to a TI-Nspire™ handheld that is powered on, TI-Nspire™ Network Manager displays the status as disconnected. TI-Nspire™ Network Manager remembers the adapter IDs you added, and the next time you turn on a handheld that is connected to the adapter, TI-Nspire™ Network Manager recognizes it.

### Manually Adding Wireless Clients

You can manually add wireless adapters at any time.

When you add a wireless adapter manually, it immediately appears in the TI-Nspire™ Network Manager window.

1. In the TI-Nspire™ Network Manager window, click **Manually Add Wireless Client(s)**.

The Add Wireless Clients by ID Number dialog box opens.

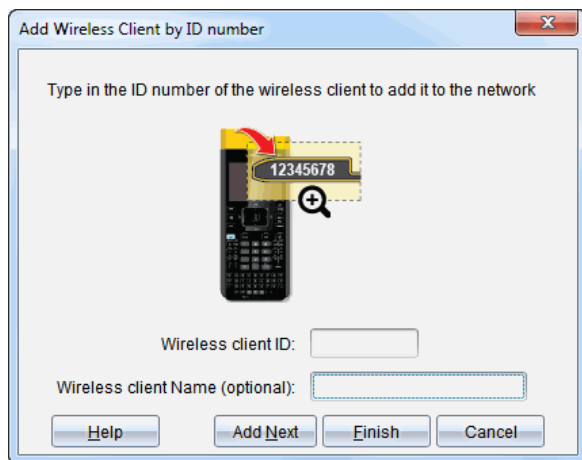

2. For each wireless adapter you are adding, find the ID number on the back of the adapter, and type it in the **Wireless Client ID** box. The ID is the last six digits of the eight-digit number (ignore the first two zeros).

3. Enter a nickname in the **Wireless Client Nickname** box (optional).

Nicknames can consist of letters, spaces, and numbers. A nickname must contain a minimum of 1 character and can contain a maximum of 64 characters.

4. Click **Add Next** to add another adapter if you have more than one wireless client to add.
5. When you are finished adding all the adapters, click **Finish**.

After you manually add wireless clients, you need to associate them to the network using the handhelds.

6. Turn on each TI-Nspire™ handheld.
7. Attach the wireless adapter to each handheld. (See the instructions for connecting wireless adapters to a TI-Nspire™ handheld.)
8. From the Home screen of the TI-Nspire™ handheld, select **5:Settings > 6:Network**.

The handheld lists the available networks that are within range.

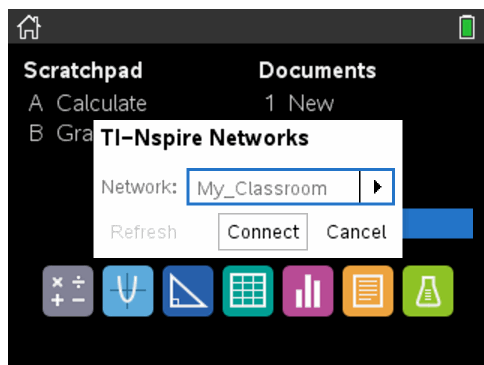

9. Select the network you added the wireless clients to, and click **Connect**.

The wireless clients are now associated with the access point.

### Changing the Operating Channel

1. In the TI-Nspire™ Network Manager window, click **Change Operating Channels**.

The Advanced Access Point Options dialog box opens.



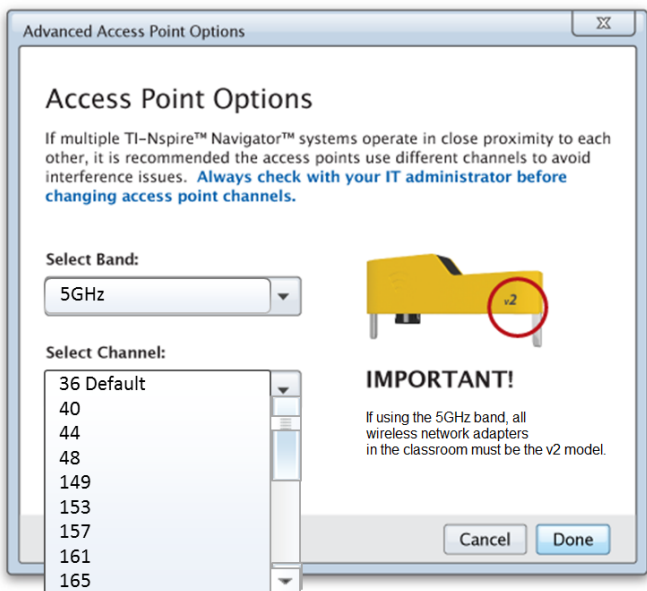

**Important!** If you are using the TI-Nspire™ CX Navigator™ network adapter – v2 adapters, you can select either the 2.4GHz or 5GHz band. If you have a mixture of wireless network adapters, you must select the 2.4GHz band.

2. Select a different channel from the drop-down box.
3. Click **Done**.

The Configuring the Access Point dialog box opens and the software configures the access point.

### Saving a Network Setup

Saving a network setup enables you to reload the configuration at a later time using the TI-Nspire™ Network Manager. The saved network information includes the list of wireless client IDs, the network name, and the channel and country selected on the access point. By default, the file is saved in the **My Documents/TI-Nspire/Navigator Network** folder.

1. In the TI-Nspire™ Network Manager window, click **Actions > Save Network Setup**.

The Save dialog box opens.

2. Name the network and then click **Save**. You can save the file to another location, if desired.

### Reusing a Saved Network

Reusing a saved network enables you to reload the configuration of a saved network. Reusing a network can save time because you do not have to set up the network again.

1. In the TI-Nspire™ Network Manager window, click **Actions > Apply Saved Network Setup**.

The Apply a Network dialog box opens.

2. Select the network and then click **Apply a Network**.
3. The access point is configured with the saved network configuration.

### Identifying Wireless Clients

To identify wireless clients that are not responding, complete the following steps.

1. From the list of hardware components in the TI-Nspire™ Network Manager window, click to select the wireless clients. To select more than one wireless client, press and hold the **Shift** or **Ctrl** key (Mac®: **⌘** key), and click the items you want to select.
2. Click **Actions > Identify Selected**.
3. Look around your classroom.
  - If you are using a docking station, both LEDs on the docking station will blink rapidly with a green color.

You can identify the wireless clients that are not working because their LEDs are **not** blinking.

Now that you know where the non-working wireless clients are, you can add them to the network again.

### Removing Wireless Clients

To remove adapters from the class network, complete the following steps.

1. In the TI-Nspire™ Network Manager window, select the wireless adapters that you want to remove from the network.
2. Click **Actions > Removed Selected**, or click .

3. When prompted, click **Remove**.

The selected wireless clients are removed from the list.

### **Resetting the Access Point to Factory Default Settings**

1. In the TI-Nspire™ Network Manager window, click **Actions > Set Default Factory Settings to Access Point**.

The access point is reconfigured to the default factory settings.

2. Click **OK** when the confirmation message is displayed.

### **Troubleshooting**

This section describes some problems you may encounter and gives suggestions on how to resolve the problem.

If you need more assistance, contact Customer Support.

#### **The software does not detect all of the handhelds that are connected.**

USB 3.0 technology limits the number of handhelds that can be detected by a computer.

To find out if you have a USB 3.0 port:

- On Windows®, go to Device Manager in the Control Panel.
- On Mac®, go to **Apple > About this Mac > More Info > System Report**, and then select **Hardware > USB** on the left panel.

You can connect and update one handheld at a time using a USB cable, or up to 10 handhelds at a time using a TI-Nspire™ CX Docking Station.

#### **During the software setup, the access point update failed.**

Disconnect and reconnect any cables connected to the access point. The software automatically starts the update process again.

#### **The updated operating system does not install on the handheld.**

Make sure the handheld is fully charged before you start an OS update.

#### **The software did not accept the class network name.**

The class network name can be up to 22 characters long. Names can consist of letters (A...Z, a...z), (0...9), and spaces; but cannot contain special characters such as ? " \$ \ ! [ ] +. Use a name that is unique, easy to remember, and easy for you to identify. For example: Ms. Smith Math Rm 65

### **The access point is experiencing connectivity problems.**

Make sure no other objects are near the access point when it is plugged in.

The access point operating channel or band may affect connectivity.

**Important!** Always check with your IT administrator before changing access point channels.

- If the TI-Nspire™ CX Navigator™ access point is connected, and you are using the TI-Nspire™ CX Wireless Network Adapter – v2 adapters, you can select either a 2.4GHz band or 5GHz band, and you can select a different operating channel.
- If you have a mixture of wireless network adapters, you must select the 2.4GHz band.

The default operating channel for 5GHz in the United States, Canada, and China is 36. The default operating channel for 5GHz in other countries is 149.

To select a different band or operating channel, go to **Tools > Network Manager** and then click **Change Operating Channel**.

### **The wireless network is not working.**

The OS on the handhelds must match the TI-Nspire™ software version on the computer in order to use the wireless network.

# Getting Started with TI-Nspire™ CX Premium Teacher Software

## Exploring the TI-Nspire™ CX Premium Teacher Software

If this is your first time using the software, the Content Workspace is open by default. Workspaces are explained in more detail below.

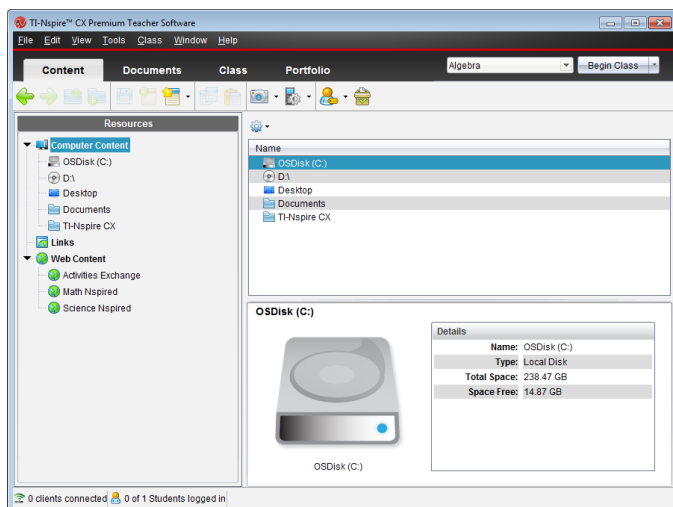

The tools described below are available in all workspaces of the TI-Nspire™ CX Premium Teacher Software. For more information on other areas of the software, see the chapter for each workspace.

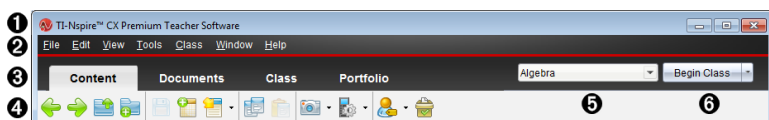

- 1 Title bar.** Shows the name of the current document and the name of the software. The minimize, maximize, and close buttons are located in the right corner.
- 2 Menu bar.** Contains tools for working with documents in the current workspace, and for modifying system settings.
- 3 Workspace Selector.** Use these tabs to switch between the Content, Class, Documents, Review, and Portfolio Workspaces.  
**Note:** Some tasks you perform may prevent you from immediately changing workspaces. If a dialog box awaits a response from you, type your response and then change workspaces.
- 4 Tools menu.** Shows tools frequently used when working in each workspace. Every

workspace has the Quick Poll, Screen Capture, and Student Name Format icons. Other tool menu options change depending on which workspace is open. Those tools are covered in their respective chapters.

- Student Name Format lets you choose how student names are displayed; either by Last Name, First Name, User Name, Display Name, Student ID, or hidden.
- The Screen Capture tool lets you take a picture of an active document on the computer, or capture the screen of one or all connected handhelds. You can take several pictures, and you can copy/paste and save the images.
- The Quick Poll tool lets you send a poll to students that they immediately receive on their handhelds, and receive student responses.

5 **Class list.** Lists classes that are currently available.

6 **Class Actions button.** Use this to begin, pause, resume, or end a class.

## Exploring Workspaces

The TI-Nspire™ CX Premium Teacher Software uses workspaces to help you easily access the tasks you most commonly perform. The software has five predefined workspaces. Each workspace is explained in additional detail in their respective chapters.

- **Content Workspace.** Find and manage content on your computer, links to websites, connected handhelds, or Texas Instruments web content.
- **Class Workspace.** Manage classes and students, use the class record panel, and exchange files with students. As with previous versions, v6.0.3 lets you mix TI-Nspire™ CX and TI-Nspire™ CX CAS handhelds in the same class. The teacher's software must be v6.0.3, and the handhelds must have v6.0.3 of the handheld operating system. Note that as of v4.0, the software does not support a mix of TI-Nspire™ and TI-Nspire™ CX handhelds.
- **Documents Workspace.** Author documents and demonstrate mathematical concepts.
- **Review Workspace.** Review a collected set of documents; mark, show, or hide student responses; switch data views; and organize data.
- **Portfolio Workspace.** Save, store, review, and manage class assignments from students.

**Note:** Only the Content and Document workspaces are displayed if Navigator has not been enabled. To enable Navigator, select **Window > Enable TI-Nspire CX Navigator**. Also, the Review workspace is displayed only when an item is open for review.

## Exploring the Status Bar

Some information in the status bar changes, depending on which workspace is open.

In all workspaces, the status bar gives you information about the network status and the student login status.

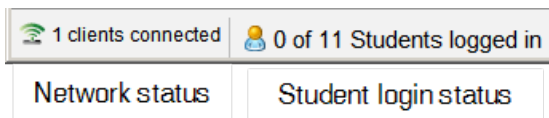

The network status shows how many TI-Nspire™ CX Wireless Network Adapters are currently connected to the system. You can click here to launch the Network Manager window.

The student login status shows how many students are currently logged into class, and how many students are assigned to the current class.

In the Documents Workspace, the status bar gives additional information.

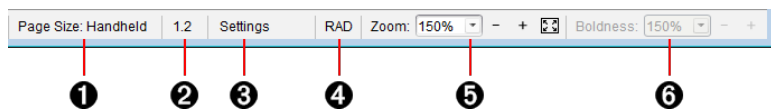

- 1 Page Size.** Shows the document's page size as Handheld or Computer. You can use the TI-Nspire™ File menu to convert a document from one page size to the other.
- 2 Problem/Page counter.** Labels the problem number and page number of the active page. For example, a label of 1.2 identifies Problem 1, Page 2.
- 3 Settings.** Double-click to view or change the Document Settings for the active document or to change the default Document Settings.
- 4 Angle Mode.** Shows an abbreviation of the angle mode (Degrees, Radians, or Gradians) in effect. Hover the pointer over the indicator to see the full name.
- 5 Zoom.** Enabled in Handheld preview only (click **Document Preview** on the toolbar and select **Handheld**). Click ▼ and select a magnification value, or click the zoom-to-fit button  to make the preview adapt automatically to window size.
- 6 Boldness.** Enabled in Computer preview only (click **Document Preview** on the toolbar and select **Computer**). Click ▼ and select a value to increase or decrease the boldness of text and other items.

In the Review Workspace, the status bar information changes, depending on the view in the Page Sorter.

- If you are in the document view, the status bar provides the same information as the Documents Workspace status bar.
- If you are in the student response view, the status bar has Data View icons. Use the icons to change between bar chart, table, and graph views.



- 1** Graph
- 2** Bar chart
- 3** Table

In the Class Workspace, the status bar has Student View icons. Use the icons to change between Seating Chart view and Student List view.

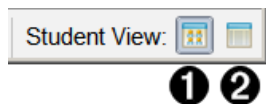

① Seating chart

② Student List

## Changing Language

Use this option to select a preferred language. You must restart the software for the language to take effect.

1. Click **File > Settings > Change Language**.

The Choose a Language dialog box opens.

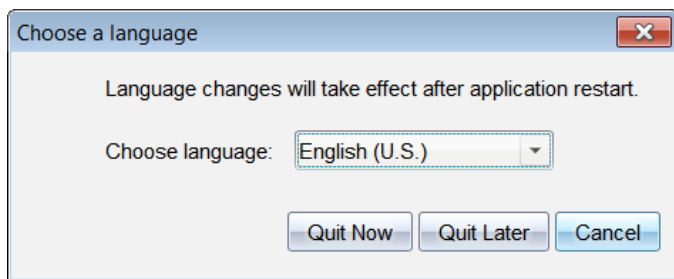

2. Click ▼ to open the Choose language drop-down list.
3. Select the desired language.
4. Click **Quit Now** to close the software immediately. You will be prompted to save any open documents. When you restart the software, the language change is effective.

—or—

Click **Quit Later** to continue your work. The language change is not applied until you close and restart the software at a later time.



# Tracking and Reporting System Use

Schools participating in research-based programs or schools receiving money from funding initiatives must track student use of the TI-Nspire™ Navigator™ systems and provide reports for auditing purposes.

To automatically track student usage of the TI-Nspire™ Navigator™ systems, a folder named "SessionLogs" is created within the appropriate TI-Nspire™ Navigator™ software folder on the teacher's computer when the software is installed. The software generates the files needed for tracking activity types, attendance, class session information, and activities that take place during a class session. The files are dependent on each other and must be kept together in the SessionLogs folder so that usage information is tracked and reported accurately.

The system automatically captures system usage data and appends the information for each new class session in the appropriate file. If the system does not find a SessionLogs folder, data is not tracked.

## *Managing Session Logs*

The system automatically generates the following comma-separated variable (csv) files and stores them in the SessionLogs folder. Each time you start the TI-Nspire™ software, logs are appended to the previous day's log to keep a complete record.

- **Activities.csv file.** Activities that take place during class sessions are recorded in this file.
- **ActivityTypes.csv file.** This file is the lookup table that the system references when generating a usage report.
- **Attendance.csv file.** Information for each student who logs into a session is recorded in this file.
- **ClassSession.csv file.** Information for all class sessions is recorded in this file.

## **Using the Activities File**

The system records information about the activities that took place during the class session in this file. Information includes:

- **ClassSessionID.** Class ID number unique to the funding program.
- **ClassName.** Name of the class as defined in the software.
- **ActivityTypeID.** Type of activity that took place during the class. The ID corresponds to the activity types defined in the Activity Type file.
- **ActivityDetail.** Additional data about the activity type if available.
- **ActivityStart.** Time the activity started.
- **ActivityEnd.** Time the activity ended.
- **NumStudent.** Number of students who participated in this activity.

## Using the ActivityTypes File

The ActivityTypes file is a look-up table that includes codes for identifying activity types and a short description of each activity.

Activity ID	Description
SC	Screen Capture
CF	Collect File
DF	Delete File
SF	Send File
RD	Redistribute
SP	Save to Portfolio
CM	Collect Missing
SM	Send Missing
US	Unprompted Send
LP	Live Presenter
QP-MC	Quick Poll - Multiple Choice
QP-OR	Quick Poll - Open Response
QP-EQ	Quick Poll - Equations
QP-CE	Quick Poll - Chemical Expression
QP-EX	Quick Poll - Expressions
QP-IL	Quick Poll - Image with labels
QP-IP	Quick Poll - Image with point(s)
QP-CP	Quick Poll - Coordinate Points
QP-LS	Quick Poll - Lists & Spreadsheet

## Using the Attendance File

The system records information for each student who logged into a session in the Attendance file. Information includes:

- **Class ID.** The Class ID number unique to the funding program.

- **Class Name.** Name of the class as defined in the software.
- **Last Name.** Last name of the student.
- **First Name.** First name of the student.
- **Date and Time.** Date and time when student logged in. Used to identify students who logged in on time versus late.
- **Student ID.** The ID of the student.

### Using the Class Session File

The system records information for each class session by Class ID. Information includes:

- **ClassSessionID.** The Class ID number unique to the funding program.
- **ClassName.** Name of the class as defined in the software.
- **Start.** Time the class started as recorded when the teacher clicks Begin Class.
- **End.** Time the class ended as recorded when the teacher clicks End Class.
- **NumStudent.** Number of students who logged in during the class session.
- **ClassSectionName.** Name of the class section.
- **QuickPollTotalTime.** Amount of time student spend on Quick Polls.

### Managing Log Files

Session log files are managed automatically based upon their file size each time the TI-Nspire™ is turned off. If the size of any one of the files is greater than 1 MB during shutdown, a backup of each file is created in the SessionLogs folder with the following names:

- Activities-bak.csv
- ActivityTypes-bak.csv
- Attendance-bak.csv
- ClassSession-bak.csv

**Note:** If a backup file already exists, it will be overwritten with a newer version.

The next time the TI-Nspire™ is turned on, four new, empty log files will be created.

### ***Packaging and Sending Session Logs***

The district administrator must report usage to the funding source for auditing purposes at regular intervals. When files are requested, teachers can easily package the session files into a zip file and send the file to the administrator. The zip file preserves the format and dependencies of the activity files, and includes a default file name that identifies the zip file for the administrator.

Complete the following steps to package the files in the SessionLogs folder into a zip file and send the file to the administrator.

1. From the Content Workspace, click **File > Package Session Logs**.

**Note:** This menu item is only available if the SessionLogs folder was created.

The previous session log content is saved. Subsequent session data will append to the existing files in the same folder as the previous sessions.

The software packages the files into a zip file and assigns a default name (TI\_PKG\_SessionLogs\_MMDDYYYY). The Logs package dialog box opens.

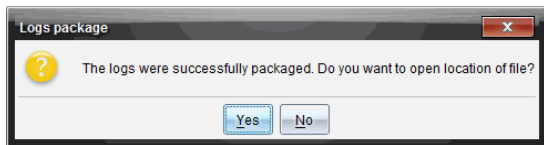

2. Click **Yes** to go to the location where the zip file was saved.

Windows® Explorer (or Finder) opens. The zip file is saved in the same location as the SessionLogs folder.

PC:

...\My Documents\My TI-Nspire CX CAS Premium Teacher Software\

Mac®:

.../Documents/My TI-Nspire CX CAS Premium Teacher Software/

3. Email the zip file to the administrator.

Data is appended to the existing file each time you start a new session. If you no longer need the information after the files are sent to the administrator, remove them from the SessionLogs folder and keep the zip file. The system will generate new files the next time you start a new session.

# Using the Content Workspace

The Content Workspace provides access and navigation to folders and files stored on your computer, network, and external drives, allowing you to open, copy, and transfer files to students.

## Exploring the Content Workspace

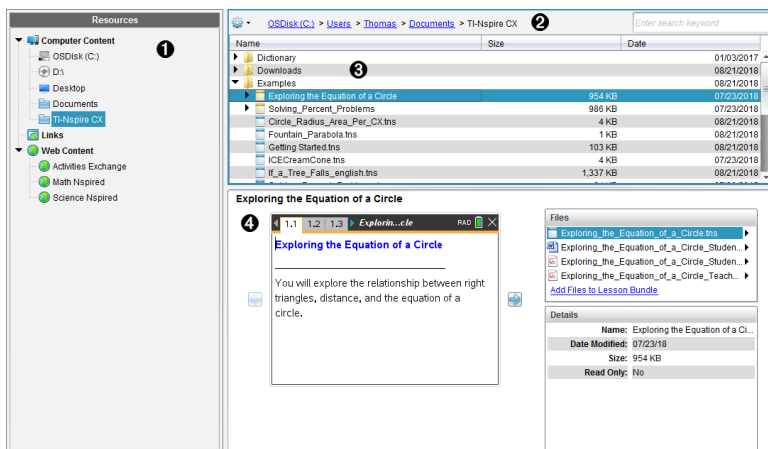

**1 Resources pane.** Select content here. You can select folders and shortcuts on your computer, network drives, external drives, or web content. If you are using software that supports TI-Nspire™ CX handhelds, the Connected Handhelds heading is visible when handhelds are connected.

**Note:** You can add new links to your favorite Web sites in the Links section. You can access these new links in the Content pane. New links may not be added to the Web content section.

**2 Navigation bar.** Navigate to any location on your computer by clicking an item in the breadcrumb trail. When you select a resource, the options shown are specific to that resource.

**3 Content pane.** By default, the folders on your desktop are displayed. Use this space to locate and view files on your computer. You can locate and access files on a connected handheld if using software that supports handhelds. Use the top half of the space as you would a file manager. The Content pane is able to display the contents of only one selected item at a time. Avoid selecting more than one item at a time.

**4 Preview pane.** Shows details about the selected file or folder.

## Exploring the Resources Pane

Use the Resources pane to locate documents on a computer, access web content, and communicate with connected handhelds if using TI-Nspire™ software that supports connected handhelds.

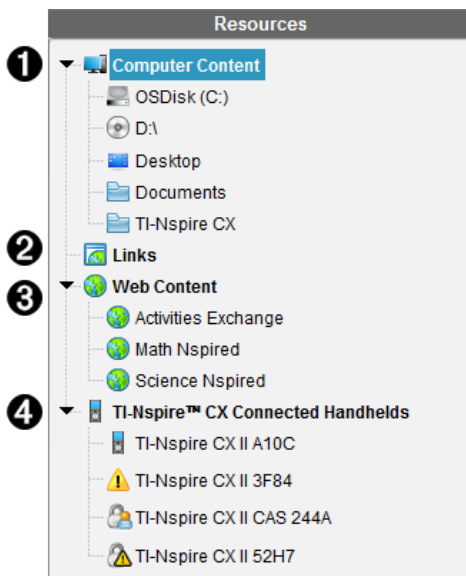

**1 Computer Content.** Enables navigation to all files on a computer, network drives, and external drives. Computer Content expands and collapses to provide access to the following default shortcuts:

- Local Disk
- External drives
- Network drives
- Desktop
- Documents or My Documents

When you select an item in Computer Content, the file structure appears in the Content pane. When you select a folder or supported file, the detail is displayed in the Preview pane.

**2 Links.** By default, links to Texas Instruments sites are listed. When you click Links, it shows a list of links in the Content pane. Then when you click a link there, it launches in your web browser. You can add your own links to this section. Links from the latest version of the TI-Nspire™ software are added when you upgrade.

Users located in the United States can search U.S. standards or textbooks by selecting the search option from Links.

**3 Web Content.** Lists links to Texas Instruments sites that contain TI-Nspire™-supported activities. Web Content is available if you are connected to the Internet. You can save material you find on these sites to your computer and share items through the Computer Content pane or Connected Handhelds if using software that supports handhelds. You cannot save links to websites in the Web Content section.

**Note:** The web content that is available varies depending on region. If there is no online content, this section is not visible in the Resources pane.

When you select an item in Web Content, the list of activities is displayed in the Content pane, and a preview of the selected activity is displayed in the Preview pane.

- 4 **TI-Nspire™ CX Connected Handhelds.** Lists information about the handhelds connected to your computer. To see folders and files on a specific handheld, click its name.

Each handheld name is shown with a status icon:

- A logged-in symbol (👤) indicates that a student is logged in to the handheld and the handheld is not in Press-to-Test mode.
- A padlock symbol (🔒) Shows that the handheld has been placed in Press-to-Test mode by the Prepare Handhelds command. If the padlock is combined with a warning symbol (⚠️), the handheld is in Press-to-Test mode but was not placed in that mode by the Prepare Handhelds command.
- A single warning symbol (⚠️) indicates that the version of the handheld OS does not match the teacher's software version.

To open a tooltip containing status details, hover the mouse pointer over the status icon.

**Note:** Connected Handhelds are not shown if there are no handhelds connected.

## Using the Preview Pane

### Lesson Bundle Example

- 1 A thumbnail preview of the selected folder, .tns file, file-type icon, or lesson bundle. Double-click a file-type icon to open the file in its associated application.

**Note:** If a lesson bundle is empty and this space is blank, you have the option to add files.

- 2 If a TI-Nspire™ document has multiple pages, use the forward arrow (➡️) to preview the next page. The backward arrow becomes active so you can move

backward through the pages. If working with a lesson bundle, you can choose to preview a TI-Nspire™ document within the bundle by this method.

- 3 If a lesson bundle is selected, the **Files** dialog box opens above the **Details** window listing the files in the lesson bundle. Double-click any file in a lesson bundle to open the file in its associated application.
- 4 If a folder is selected, the **Details** window shows the name of the folder, the path where the folder is located, and the date modified.  
For document files and lesson bundle files, the **Details** window shows the name, the date the file was modified, the file size, and whether or not the file is read only.

## Accessing Computer Content

Computer Content provides access to all information stored on your computer, network, and external drives.

### Using the Navigation bar

The Content pane Navigation bar provides tools needed to locate folders and files.

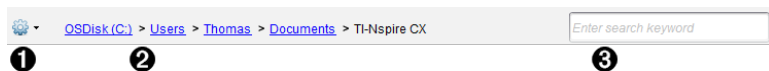

- 1  **Options:** Click ▼ to open the menu to access options for working with files and folders.
- 2 **Current path:** Contains a clickable breadcrumb trail of the current location. Click a breadcrumb to navigate to any section in the path.
- 3 **Search:** Enter a search keyword and press **Enter** to find all files within the selected folder containing that word.

### Filtering Computer Content

Use this filtering option for easy access and selection of your teaching content. You can select show TI-Nspire™ content only or to show all content.

1. Select a folder in Computer Content in the Resources pane.
2. From the Menu bar, select **View > Filter by**.
3. Choose one of the following options.
  - **Show TI-Nspire™ content only**
  - **Show all content**

### Mapping a Network Drive

Complete the following steps to map a network drive.

1. Select Computer Content from the Resources list.
2. Click  , and then click **Create Shortcut**.



The Add Shortcut location to Content dialog box opens.

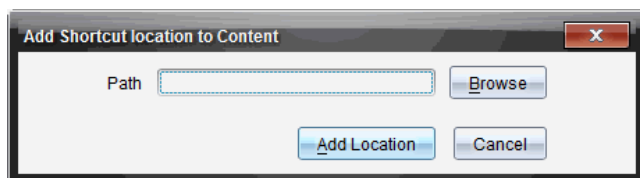

3. Click **Browse**.

**Note:** You can also type the full path name for the network drive.

The Select Shortcut Folder dialog box opens.

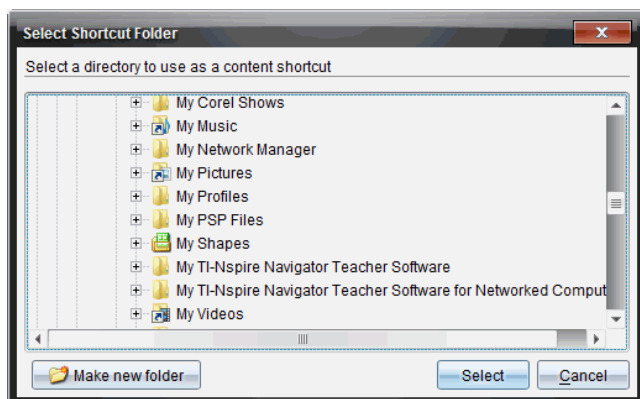

4. Navigate to the network drive.
5. Click **Select**.
6. Click **Add Location**.

The Please enter network drive credentials dialog box opens.

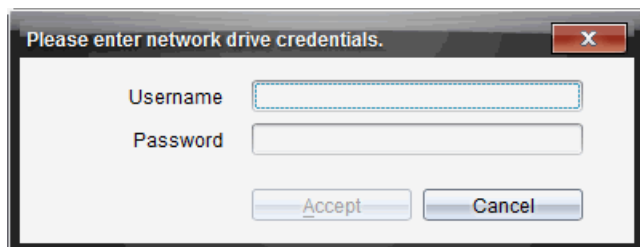

7. Type the username and password given to you by your system administrator.
8. Click **Accept**.

The network drive is added to the list of folders under the Computer Content heading in the Resources pane.

### Accessing a Secured Network Drive

If access to a network drive requires authentication, complete the following steps to access secured network.

1. Click the drive you want to access in the Resources pane.

The Please enter network drive credentials dialog box opens.

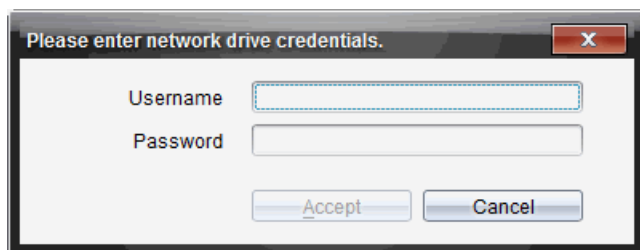

2. Type your username and password.
3. Click **Accept**.

### Using Shortcuts

Use this option to add folders or lesson bundles containing frequently used files to the Computer Content list.

#### Adding a Shortcut

To add a shortcut to a folder containing files you access often:

1. Navigate to the folder where the files are located.

2. Click  , and then click **Create Shortcut**.

The folder is added to the list of folders under Computer Content in the Resources pane.

#### Deleting a Shortcut

To delete a shortcut:

1. From the Computer Content list, select the folder to be deleted.
2. Right-click the selected folder, and then click **Remove Shortcut**.

The folder is removed from the list of shortcuts.

**Note:** You cannot remove default shortcuts.







## Working with Links

By default, the Links list contains a list of links to Texas Instruments websites. Click a link to launch your web browser and access the website.

### Using the Links Toolbar

When you select Links in the Resources pane, the tools on the navigation bar are specific to working with links. Use these tools to add, edit, or delete links from the list. You can also move a link up or down in the list.



	<b>Options.</b> Click ▼ to open the menu to access options for working with links.
	Click this icon to add a link to the list.
	Select an existing link, and then click this icon to edit the link's attributes. You cannot edit a default link.
	Click this icon to delete a link. You cannot delete a default link.
	Select a link and click this icon to move the link up in the list.
	Select a link and click this icon to move the link down in the list.

### Adding a Link

Complete the following steps to add a link to the list of Links in the Resource pane.

1. Click  .

The Add Link dialog box opens.

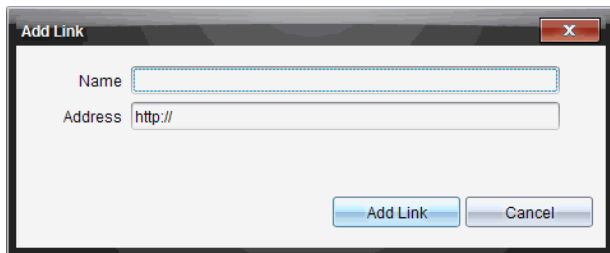

2. Type the name of the link.
3. Type the URL in the Address field.
4. Click **Add Link**.

The link is added to the bottom of the list of existing links.

### Editing an Existing Link

Complete the following steps to edit an existing link.

1. Select the link you want to change.



2. Click .

The Edit Link dialog box opens.

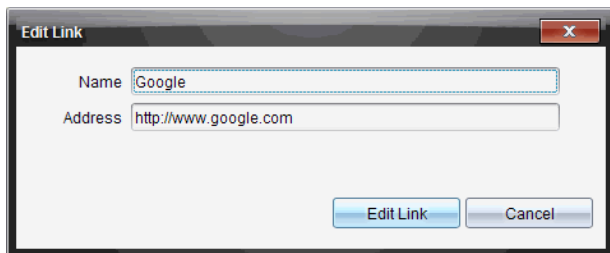

3. Make needed changes to the name of the link or to the URL.
4. Click **Edit Link**.

The changes are applied to the link.

### Removing a Link

Complete the following steps to delete a link.

1. Select the link you want to delete.



2. Click .

The confirmation dialog box opens.





### 3. Click **Remove**.

The link is removed from the list.

**Note:** You cannot delete a default link.

### Moving Links Up or Down in the List

You can change the order of the links in the list to suit your needs.

- ▶ Click  to move a selected link up one place in the list.
- ▶ Click  to move a selected link down one place in the link.
- ▶ Click , and then select **Move to Top of List** to relocate a selected link to the top of the list.
- ▶ Click , and then select **Move to Bottom of List** to relocate a selected link to the bottom of the list.

### Using Web Content

Web Content provides links to online materials on Texas Instruments websites. You can save material found on these websites to your computer and share them using the Computer Content pane and Connected Handhelds.

Information provided for each activity includes the name of the activity, the author, the date the activity was posted, the size of the file, and the source.

1  Subject: All Topic: All Category: All

Name	Author	Date Posted	Size	Source
Forensics with	Texas Instruments	4/1/13	934 KB	Activities Exchange
Forensics with	Texas Instruments	4/1/13	986 KB	Activities Exchange
Forensics with	Texas Instruments	4/1/13	834 KB	Activities Exchange
NASA - Diving Down	NASA and TI	3/26/13	1585 KB	Activities Exchange
Exploring Ellipses and	Texas Instruments	2/25/13	1477 KB	Activities Exchange
Exploring Hyperbolas	Texas Instruments	2/25/13	1367 KB	Activities Exchange
Exploring Parabolas	Texas Instruments	2/4/13	1065 KB	Activities Exchange
The Radian Sector	Texas Instruments	1/24/13	814 KB	Activities Exchange
Blood Pressure	Texas Instruments	1/9/13	820 KB	Activities Exchange
3D Parametric	Texas Instruments	1/8/13	1090 KB	Activities Exchange
Health and Nutrition -	Texas Instruments	12/4/12	8594 KB	Activities Exchange
Health and Nutrition -	Texas Instruments	12/4/12	363 KB	Activities Exchange
Stay Tuned Lab Sound	Lauren Jensen	9/1/12	168 KB	Activities Exchange

2

3

**Forensics with TI-Nspire™ - Case 2: Bouncing Back**

In this activity, students will be using the motion sensor as a sonar detector, through air to locate and identify a missing object in a box.

4 Save this Activity to Computer

Files

- Case\_2\_Bouncing\_Back.tns
- Case\_2\_Bouncing\_Back\_Student.pdf
- Case\_2\_Bouncing\_Back\_Teacher.pdf

5 Details

Name: Forensics with TI-Nspire™ -  
Author: Texas Instruments  
Date Posted: 4/1/13  
Size: 986 KB  
Source: Activities Exchange  
Activity Time: 45 Minutes  
Device: TI-Nspire™ Navigator™ TI-Ns-

- 1 Navigation toolbar.
- 2 Column headings.
- 3 List of available activities.
- 4 List of the files contained in the activity.
- 5 Details about the selected activity.

**Note:** An Internet connection is required to access Texas Instruments websites.

### Sorting the List of Activities

Use the column headings to sort the information in the list of activities. By default the list is displayed in alphabetical order by Name.

- Click the Name heading to list activities in reverse alphabetical order. Click the heading again to return to A to Z order.
- Click the Author heading to list the activities in alphabetical order by author name.
- Click the Date Posted heading to list the activities in order from newest to oldest or from oldest to newest.
- Click the Size heading to list the activities according to file size.
- Click the Source heading to list the activities in order by source.
- Right-click the column heading row to customize displayed column headings.

### Filtering the List of Activities

By default, all available activities are listed in the Content pane. Options on the Navigation bar enable you to filter the activities by subject, topic, and category. You can also search for an activity using a keyword search.

To find all activities related to a particular subject:

1. In the Subject field, click ▼ to open the drop-down list.
2. Select a subject.

All activities related to the selected subject are listed.

3. To narrow the search, click ▼ in the Topic field to view and select a topic related to the subject selected.
4. Use the Category field to narrow the search even further. Click ▼ to select a category related to the selected subject and topic.

## Using Keywords to Search for an Activity

Complete the following steps to search for an activity using a keyword or phrase.

1. Type a keyword or phrase in the Filter by Keyword field.
2. Press **Enter**.

All activities that contain the keyword or phrase are listed.

## Opening an Activity

1. Select the activity you want to open.

2. Click , and then select **Open**.

The Open Activity dialog box opens with a list of all documents related to the selected activity.

You can open a .tns file in the TI-Nspire™ software. Other files such as Microsoft® Word and Adobe® PDF files open in their respective applications.

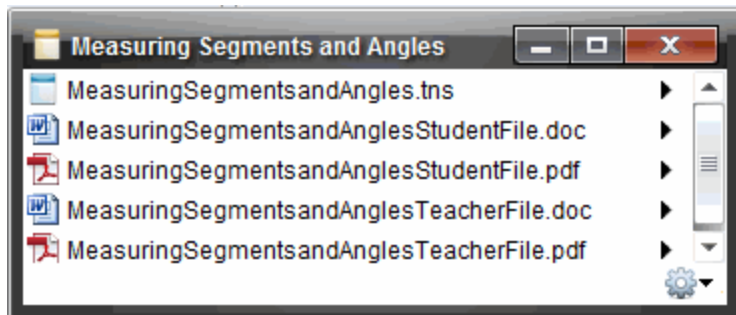

3. Select the file and click , and then select **Open**.
  - The .tns file opens in the Documents Workspace.
  - The .doc or .pdf file opens in its associated application.

## Saving an Activity to Your Computer

Complete the following steps to save an activity to your computer.

1. Select the activity you want to save. The file details are displayed in the bottom half of the window.

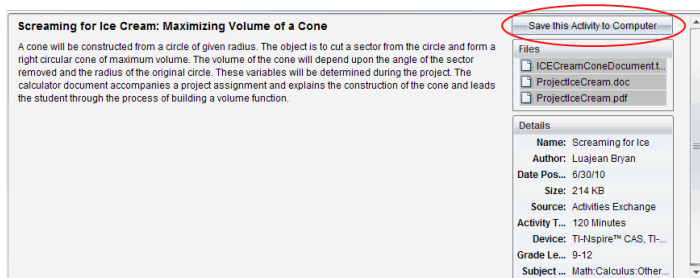

2. Click **Save this Activity to Computer** in Preview pane, above Files.

**Note:** You can also right-click on the selected activity and choose **Save to Computer**.



The Save Selected files dialog box opens.

3. Navigate to the folder where you want to save the file.
4. Click **Save**.

The activity is saved to your computer as a lesson bundle.

### Copying an Activity

Complete the following steps to copy an activity. Once the activity is copied to the Clipboard, you can paste the activity into a folder on your computer, and then drag the activity to your list of shortcuts in the Local Content pane.

1. Click the activity you want to copy to select it.
2. Use one of the following methods to copy the activity to the Clipboard:
  - Select the activity and drag it to a folder in the Local Content list.
  - Click , and then click **Copy**.
  - Right-click on a file in the Files list, and then click **Copy**.
  - Click  (Copy icon), which is located in the toolbar.

The activity is copied to the Clipboard.

3. Open a folder on your computer, and then click **Edit > Paste** to copy the activity to the selected folder.

### Sending Files to Class

You can send files and folders to your whole class, members of the class currently logged in, or to individual students. Class must be in session for you to send the files.



When you send a file to the whole class, all students currently logged in will receive the file immediately. Students not logged in will receive the file when they log in.

#### Notes:



- Only TI-Nspire™ (.tns) files open in the TI-Nspire™ software.
- Other file types (if supported) such as images, word processing, or spreadsheet files, open in the application the operating system has associated with the file type.

#### Sending Files from the Content or Documents Workspaces

1. Select the file you want to send to the class.
  - From the Content Workspace, click the file in the Content pane.
  - From the Documents Workspace, click the file in the Content Explorer.
2. Click **Send to Class** , or click **File > Send to > Send to Class**.

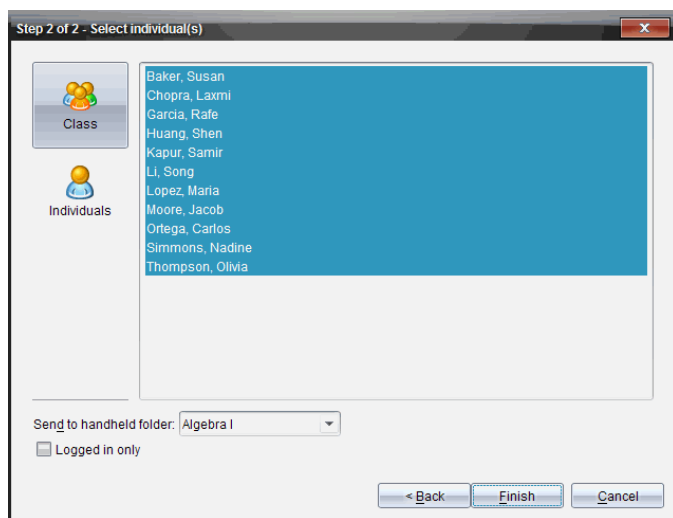
The Select individual(s) dialog box opens.



3. Select the student(s) to whom you want to send the file:
  - To send the file to the whole class, click **Class** . To send the file only to class members who are currently logged in, select the **Logged in only** check box.
  - To send the file to an individual student, click **Individuals**  and then click the student.

**Note:** If you had any students selected in the classroom area, the software already has them selected.

- Use the **Send to handheld folder** drop-down list to choose from the current class folder, the top level folder on the handheld, or the last 10 folders that files were sent to. (Available only on TI-Nspire™ software that supports handhelds.)

4. Click **Finish**.

The file transfer appears in the Class Record in the Class Workspace.

## Working with Connected Handhelds

The TI-Nspire™ software enables you to view content, manage files, and install operating system updates on handhelds connected to the computer.

To use the features described in this chapter, handhelds must be turned on and connected by one of these means:

- TI-Nspire™ Docking Station or TI-Nspire™ CX Docking Station
- TI-Nspire™ Navigator™ Cradle and access point
- TI-Nspire™ CX Wireless Network Adapter and access point
- TI-Nspire™ CX Wireless Network Adapter - v2 and access point
- A direct connection through a standard USB cable

For web-based connectivity using your TI-Nspire™ CX II with a Chromebook, Windows® computer, or Mac® computer, go to [TI-Nspire™ CX II Connect](#).

**Note:** The tasks in this section can only be performed using TI-Nspire™ handhelds. In order to enable wireless connectivity, the TI-Nspire™ Premium Teacher Software and the OS installed on the TI-Nspire™ CX II handhelds must be version 5.0 or later. For TI-Nspire™ CX handhelds, the OS must be version 4.0 or later.

### Viewing Content on Connected Handhelds

When you select a handheld in the Resources pane in the Content Workspace, all files and folders on the handheld appear in the Content pane. To preview the document contents, select [Click here to preview document](#) in the Preview pane.

The screenshot shows the TI-Nspire software interface. On the left is the 'Resources' pane with a tree view. A red circle '1' is next to 'TI-Nspire™ CX Connected Handhelds'. The main window has a 'Look in' dropdown set to 'Connected Handhelds'. A table lists connected handhelds with columns for Name, Battery (LI-Ion), Battery (AAA), Storage / Size, and OS version. A red circle '2' is above the table, and a red circle '3' is to the right of the first row. Below the table is a preview area for a 'TI-Nspire CX II A10C' handheld. A red circle '4' is next to the handheld image. To the right of the image is a 'Handheld Information' box with the following data:

Handheld Information	
Handheld Type:	TI-Nspire CX II
Product ID:	1D20008000000086646D87...
Boot ROM:	5.0.0.42
Boot Loader:	5.0.0.54
Operating System:	5.0.0.796
Available Space:	92.0/92.3 MB
Battery (LI-Ion):	75%
Battery (AAA):	--

- 1** **TI-Nspire™ CX Connected Handhelds** - Lists all handhelds that are connected and turned on.

**Note:** A warning symbol next to the handheld name indicates that the OS installed on

the handheld does not match the software version installed on the computer and that an OS update is needed.

- ② **Options** - Available options vary depending on the task you select under Resources.
- ③ **Content pane** - When Connected Handhelds is selected, the Content pane shows details about handhelds that are connected and turned on:
  - **Name**
  - **Battery (Li-ion)** - Li-ion (rechargeable) battery charge (Critical 2%, 25%, 50%, 75%, 100%, or "--" to indicate no battery is present).
  - **Battery (AAA)** - AAA battery charge (Critical 2%, 25%, 50%, 75%, 100%, or "--" to indicate no battery is present).
  - **Storage Size**
  - **OS Version**
- ④ **Preview pane** - Provides information on a handheld when you click Connected Handhelds in the Resources pane and then a handheld in the Content pane. If you select a TI-Nspire™ file in the Content pane, the Preview pane shows a preview available for that file.
  - **Handheld Type:** Names of handhelds.
  - **Product ID:** Handheld product identification.
  - **Boot ROM:** Internal bootstrap that performs lower level operation for booting up device.
  - **Boot Loader:** External bootstrap that performs lower level operation for booting up device.
  - **Operating System:** The operating system in use.
  - **Available Space:** The amount of space left and available on the handheld.
  - **Battery (Li-ion)** - Li-ion (rechargeable) battery charge (Critical 2%, 25%, 50%, 75%, 100%, or "--" to indicate no battery is present).
  - **Battery (AAA)** - AAA battery charge (Critical 2%, 25%, 50%, 75%, 100%, or "--" to indicate no battery is present).

When you select a handheld, all files and folders on the handheld appear in the Content pane. When a file or folder is selected, the details are displayed in the Preview pane. Click the icon to preview the document.

Name	Size
▶ 7th Period Geometry	
▶ Algebra I	
▶ Algebra II	
▶ Examples	
00 Getting Started.tns	103 KB
01 Percentage Explorer.tns	8 KB
02 Introducing Functions.tns	26 KB
03 Linear Equations Explorer.tns	16 KB
04 Systems of Equations Explorer.tns	26 KB
05 Introducing Geometry.tns	8 KB
NspireLogs.zip	

Details about the selected folder or file are shown in the Preview pane.

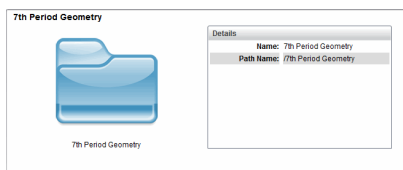

Details for selected folder

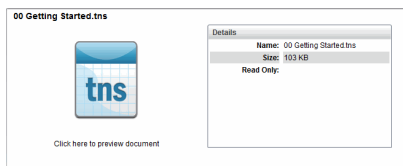

Details for selected file

- ▶ To view the files in a folder, double-click the folder name in the Content pane. The files in the folder are listed in the Content pane.
- ▶ To preview the contents of a .tns file, select **Click here to preview document** in the Preview pane.

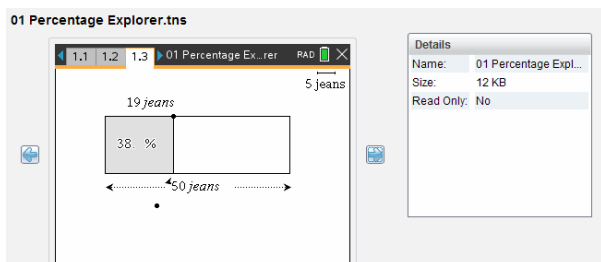

## Managing Files on a Connected Handheld

When working with files on connected handhelds in the Content Workspace, use the Options menu  or the context menu to manage files.

**Note:** If you select a file type that is not supported on the handheld, some selections in Options menu are not active.

Option	How it Works
Open	<p>Open a file on a connected handheld:</p> <ul style="list-style-type: none"> <li>• Click the file you want to open.</li> <li>• Click <b>Open</b>. The document opens in the Documents</li> </ul>

Option	How it Works
	Workspace.
Save to Computer	<p>Save a copy of the selected file on your computer:</p> <ul style="list-style-type: none"> <li>• Click the file you want to save.</li> <li>• Click <b>Save to Computer</b>. The Save Selected Files dialog box opens.</li> <li>• Navigate to the folder where you want to save the file.</li> <li>• Click <b>Save</b>.</li> </ul>
Copy/Paste	<p>Create a copy of a file:</p> <ul style="list-style-type: none"> <li>• Click the file you want to copy.</li> <li>• Click <b>Options &gt; Copy</b> to copy the file to the Clipboard.</li> <li>• To paste the file in another location, navigate to the new location, and then click <b>Options &gt; Paste</b>.</li> </ul> <p><b>Note:</b> If you don't select a new location, the copied file is pasted with a new name "Copy of ..."</p>
Delete	<p>Delete a file on a connected handheld:</p> <ul style="list-style-type: none"> <li>• Click the file you want to delete.</li> <li>• Click <b>Delete</b>.</li> <li>• Click <b>Yes</b> when the Warning dialog box opens. Click <b>No</b> to cancel.</li> </ul>
Refresh	To refresh the list of files, click <b>Options &gt; Refresh</b> .
Rename	<p>To rename a file on a connected handheld:</p> <ul style="list-style-type: none"> <li>• Click the file you want to rename.</li> <li>• Click <b>Options &gt; Rename</b>.</li> <li>• Type the new name and press <b>Enter</b>.</li> </ul>
Up a Level	Go up a level in the folder hierarchy. This option is available when you select a file inside a folder.
New Folder	<p>Create a new folder:</p> <ul style="list-style-type: none"> <li>• Click <b>New Folder</b>.</li> <li>• Type a name for the new folder.</li> <li>• Press <b>Enter</b>.</li> </ul>

### Opening Documents on a Connected Handheld

To open a document on a connected handheld in the TI-Nspire™ software:

1. Ensure the handheld is connected to your computer.

2. Click  to open Content Explorer.

The connected handheld name is listed in the Connected Handhelds pane.

3. Double-click the handheld name.

The folders and documents on the handheld are listed.

4. Navigate to the document you want to open, and then double-click the file name.

The document opens in the Documents Workspace.

### **Saving Files to a Connected Handheld**

When you save a file from your computer to a handheld, files are converted to TI-Nspire™ documents (.tns files). (See *Sending Files to Handhelds*)

To save a file on your computer to a connected handheld:

1. Ensure the handheld is connected to your computer.

2. Click  to open Content Explorer.

The folders and files on your computer are listed in the Computer pane.

3. Navigate to the folder or file you want to save to the handheld.

4. Click the file to select it.

5. Drag the file to a connected handheld listed in the Connected Handheld pane.

The file is saved to the connected handheld.

**Note:** To save the file in a folder on the handheld, double-click the handheld name to list the folders and files, and then drag the file to a folder on the handheld.

If the file already exists on the handheld, a dialog box opens asking if you want to replace the file. Click **Replace** to overwrite the existing file. Click **No** or **Cancel** to abandon the save.

### ***Sending Files to Handhelds***

You can transfer activities, folders, lesson bundles, and supported files from a computer to connected handhelds, from one connected handheld to another, or from one connected handheld to all connected handhelds.

Items you can transfer include:

- Folders
- Supported files

.tcc  
.tco  
.tcc2  
.tco2  
.tct2

.tilb  
.tns

## Sending an Activity to a Connected Handheld

In the Content Workspace, you can send an activity from the Web Content link to connected handhelds.

1. Use the Workspace selector to select the Content Workspace.
2. Click Web Content in the Resources pane.
3. Click the activity you want to send to connected handhelds.
4. Use one of the following options to send the file to the selected handhelds:
  - Drag the file to the Selected Handhelds label to transfer the file to all connected handhelds. To transfer the file to a specific handheld, drag the file to a specific handheld name.
  - To transfer the file using Transfer Tool:

**Note:** You cannot use the Transfer Tool to transfer files to handhelds while a class is in session.
5. From the toolbar, click , and then select **Send to Connected Handhelds**.

—or—

Click , and then select **Send to Connected Handhelds**.

The Transfer Tool opens.

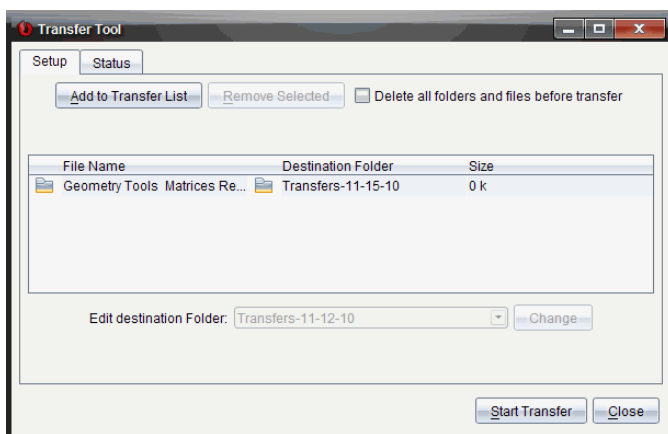



6. Select the file, and then click **Start Transfer**.

The selected files and folders are transferred to the selected handhelds.

7. When the transfer is complete, close the Transfer Tool.

### **Sending Files to all Connected Handhelds**

You can send a file to all connected handhelds when a class is not in session. To transfer files or folders from a connected handheld or from the computer to all connected handhelds, complete the following steps:

1. Use the Workspace selector to select the Content Workspace.
2. Select the files or folders you want to transfer from the Resources pane.

**Note:** You can choose files from Computer Content, Web Content, or Connected Handhelds.

3. Click , and then click **Send to Connected Handhelds**.

The Transfer Tool window opens.

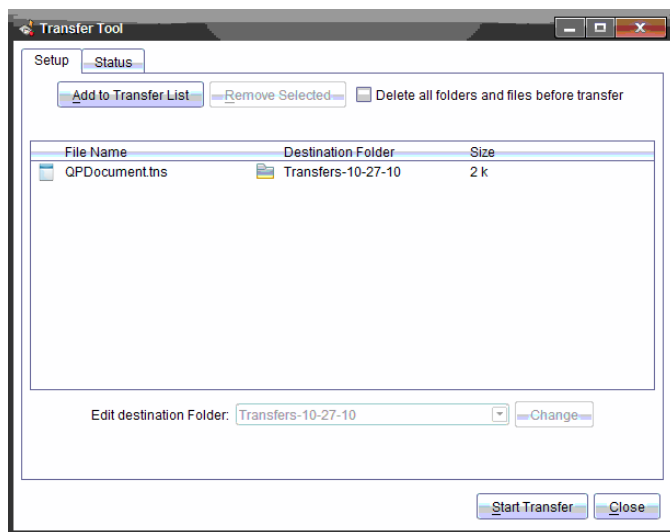

4. Click **Start Transfer**.

**Note:** To add additional files to the transfer list, click **Add to Transfer List**.

The selected files and folders are transferred to the connected handhelds. By default, the files are transferred to a folder on the handheld titled *Transfers-mm-dd-yy*.

## Transferring Files Between Handhelds

If multiple handhelds are connected, you can send a folder or file from one handheld to another handheld in the Connected Handhelds list in the Resources pane.

1. Use the Workspace selector to select the Content Workspace.
2. In the Resources pane, click the handheld that contains the files you want to transfer. The files on the handheld are listed in the Content pane.
3. Click the folder or file you want to send.
4. Drag the file to another handheld in the Connected Handhelds list.

**Note:** You can also copy and paste a file from one handheld to another.

## Preparing Handhelds Remotely

TI-Nspire™ Premium Teacher Software lets you change settings on connected handhelds from your computer. The handhelds can be connected through wired or wireless connections.

You don't need to start a class session or require students to log in. You can perform these operations while other transfer activities, such as Quick Poll or Live Presenter, are in progress.

## Clearing the Scratchpad

This removes all Scratchpad data from the connected handhelds, including the Scratchpad Calculator pages and Graphs & Geometry pages, the Scratchpad history and variables, and the contents of each handheld's clipboard. The handhelds can be in or out of Press-to-Test mode.

**WARNING:** This action clears the Scratchpad and Clipboard data from *all currently connected handhelds*. You cannot limit it to a selected set of handhelds.

1. From the **Tools** menu, select **Prepare Handhelds > Clear Scratchpad**.

A Clear Scratchpad confirmation message appears.

2. To proceed, click **Clear Scratchpad**.

A status log reports the progress. A notification message appears on each handheld.

## Configuring Document Settings

This lets you apply document settings, such as Angle unit and Calculation Mode, to the connected handhelds. It gives you a quick way to put all the handhelds into a known state. You can choose to save configurations for reuse. The handhelds can be in or out of Press-to-Test mode.

**Note:** The document settings are applied immediately to handheld Scratchpads and are saved as defaults for the Scratchpad and all new documents. Existing documents, whether open or closed, retain their prior settings.

1. From the **Tools** menu, select **Prepare Handhelds > Set Default Document Settings**.

The Document Settings dialog box opens, showing the setting that will be applied.

2. Click each option that you want to change, and select the desired setting.
  - To apply a previously saved configuration, click the **Saved Configuration** list, and select the configuration.
  - To restore factory default settings, click the **Saved Configuration** list, and select **TI Factory Default**.
3. (Optional) To save the current settings as a named configuration, click **Save**, type a **Name** into the Save Configuration dialog box, and click **Save**.
4. Click **Send**.

A notification message appears on each handheld, and a status log reports errors and warnings to the teacher. Click **Done** to close the log.

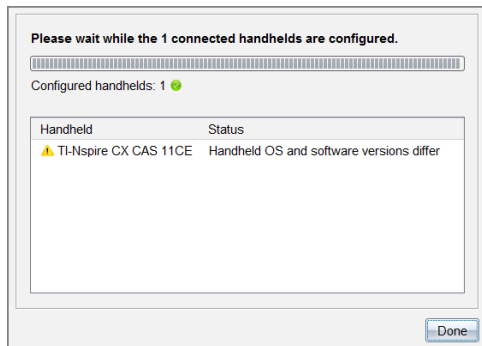

## Entering Press-to-Test Mode on the Handhelds

This lets you start a Press-to-Test session on the connected handhelds and apply the same set of restrictions to each by choosing them from a dialog and optionally saving the configurations for reuse. Or you can enter a Test Code that contains a pre-defined set of restrictions.

**WARNING:** *All currently connected handhelds will restart, including any handhelds that are already in a Press-to-Test session. You cannot limit this action to a selected set of handhelds.*

### Choosing Test Mode Restrictions

1. From the **Tools** menu select **Prepare Handhelds > Send Press-to-Test > Choose Test Mode Restrictions**.

The Press-to-Test Configuration dialog box opens, showing the restrictions that will be applied.

2. Click the check box for each restriction to select or deselect it.

In the Test Code section, the code will automatically update based on your selections.

3. (Optional) To save the current settings as a named configuration, click **Save**, type a **Name** into the Save Configuration dialog box, and click **Save**.
4. Click **Send Press-to-Test**.

A warning message lists the effects of entering a Press-to-Test session.

5. To proceed, click **Enter Press-to-Test**.

### Entering a Test Code

To enter a test code, you can use one provided to you, or one generated using the above method.

1. From the **Tools** menu select **Prepare Handhelds > Send Press-to-Test > Enter Test Code**.

The Press-to-Test Configuration dialog box opens showing the most recent test code, or blanks if it is your first-ever session.

2. Enter a test code in the numeric boxes.

The test code will be validated as you enter each of the eight numbers and will display a message accordingly. You will not be able to start Press-to-Test without a valid test code.

- (Optional) To save the current test code as a named configuration, click **Save**, type a **Name** into the Save Configuration dialog box, and click **Save**.
- Click **Next**.

The Press-to-Test Configuration dialog box opens showing the valid test code, the angle setting, CAS mode, and a list of the restrictions.

- Click **Send Press-to-Test**.

Each handheld preserves its current files and settings and then restarts in Press-to-Test mode. A status log reports errors and warnings to the teacher. Click **Done** to close the log.

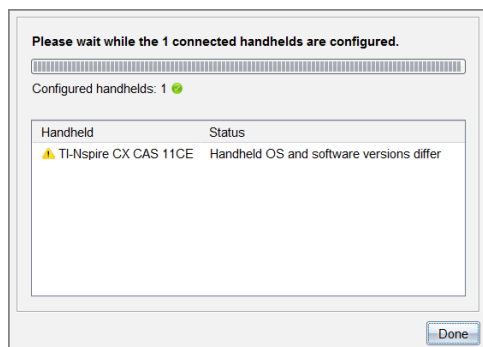

### Exiting Press-to-Test mode

This closes the Press-to-Test session on the connected handhelds and restarts them.

**WARNING:** *All currently connected handhelds will exit Press-to-Test and restart. All data and files created while in Press-to-Test will be deleted. You cannot limit this action to a selected set of handhelds.*

- Notify the students that you are about to close the Press-to-Test session on their handhelds.
- From the **Tools** menu, select **Prepare Handhelds > Exit Press-to-Test**.  
A warning message lists the effects of exiting a Press-to-Test session.
- To proceed, click **Exit Press-to-Test**.

A status log reports the progress. Each handheld restarts with its previous files and settings restored.

## Checking for an OS Update

When handhelds are connected, you can check for OS updates from the Content Workspace or from the Documents Workspace.

**Note:** Your computer must be connected to the Internet.

1. Show all connected handhelds.
  - In the Content Workspace, click **Connected Handhelds** in the Resources pane.
  - In the Documents Workspace, open the Content Explorer and click **Connected Handhelds**.
2. Click the handheld you want to check, and then right-click and select **Check for OS Update**.
  - If the operating system is current, the Check for Handheld OS Update dialog box opens indicating that the operating system on the handheld is current.

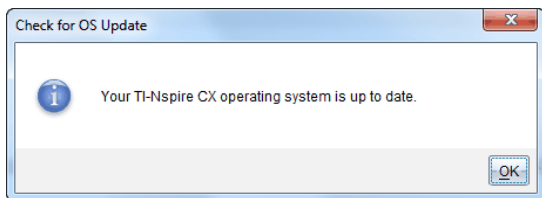

- If the operating system is not current, the TI-Nspire™ software prompts you to install the latest OS now, with the option to download the OS to your computer.

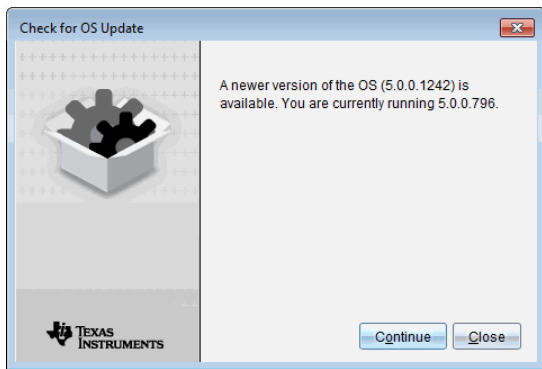

3. Click **Close** to close the dialog box, or click **Continue** and follow the prompts to install the OS on the handheld.

## Installing an OS Update

**Note:** To avoid losing unsaved data, close all documents on the handheld before updating its operating system (OS). Updating the OS does not replace or remove previously saved documents.

The OS on a new handheld comes bundled with the installer, which places the OS in a default location such as: C:\mydocuments\TI-Nspire\downloads.

Go to [education.ti.com/latest](http://education.ti.com/latest) to download the latest OS files.

**Note:** You can install OS updates on connected handhelds from the Content Workspace at any time.

### Updating the OS on a Single Handheld

1. Ensure that your computer is connected to the internet.
2. Show all connected handhelds by clicking the arrow next to **TI-Nspire™ Connected Handhelds** in the Resources pane.

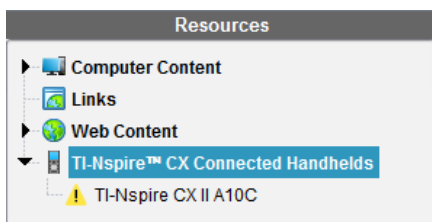

**Note:** An attention ⚠ symbol next to a handheld name means:

The handheld needs an OS update.

—or—

The handheld has a newer OS than the teacher's.

3. Hover your mouse over the TI-Nspire™ handheld you want to update, and then right-click.
4. Click **Check for OS Update**.

The Check for OS Update dialog box opens.

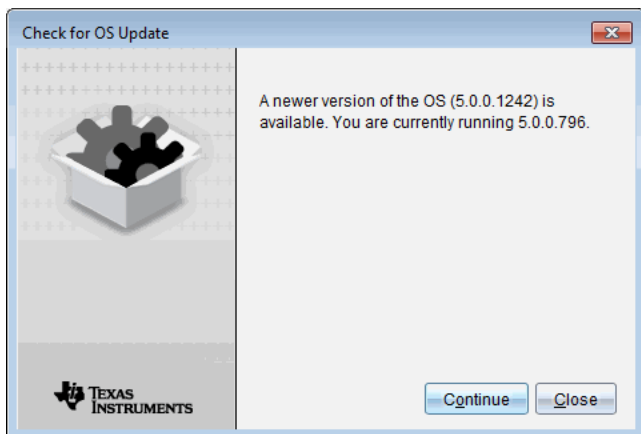

5. Click **Close** to cancel the installation, or click **Continue** and follow the prompts to install the OS on the handheld.

When the update is complete, the handheld restarts automatically.

### Updating the OS on Multiple Handhelds

**Note:** To avoid losing unsaved data, close all documents on the handheld before updating its operating system (OS). Updating the OS does not replace or remove previously saved documents.

1. Click **TI-Nspire™ Connected Handhelds** in the Resources pane.
2. Select all handhelds you want to update in the Content Pane.
3. Click **Tools > Install OS**.

The OS Installation dialog box opens.



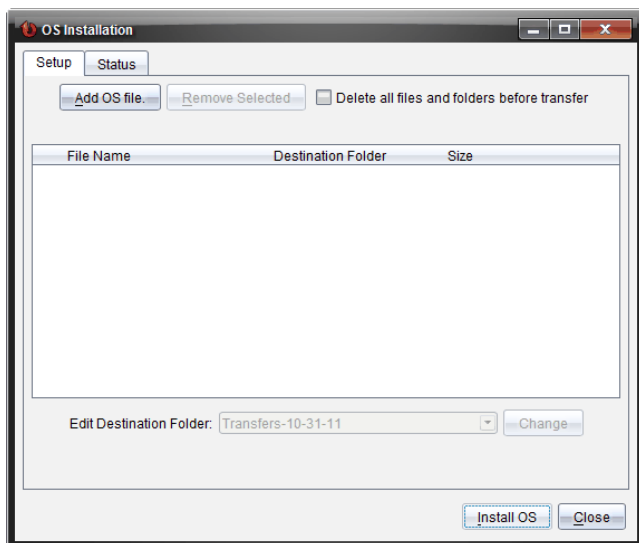

4. Click **Add OS file**.

The Add to Transfer List dialog box opens.

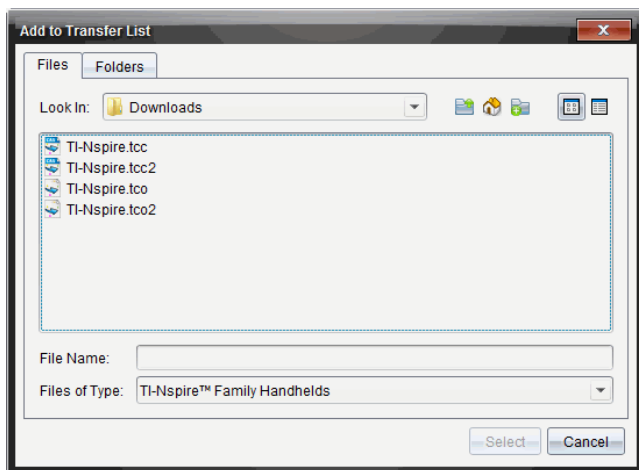

5. Select the applicable OS files.

- To upgrade a TI-Nspire™ CX handheld, select TI-Nspire.tco.
- To upgrade a TI-Nspire™ CX CAS handheld, select TI-Nspire.tcc.
- To upgrade a TI-Nspire™ CX II handheld, select TI-Nspire.tco2.

- To upgrade a TI-Nspire™ CX II CAS handheld, select TI-Nspire.tcc2.
- To upgrade a TI-Nspire™ CX II-T handheld, select TI-Nspire.tct2.

6. Click **Select**.

The OS Installation redisplay with your selected OS files.

7. Click **Install OS**.

The OS version information updates, and the Select OS Handheld File dialog redisplay for further selection.

## ***Renaming Handhelds***

You can rename the handhelds from the Content Workspace.

**Note:** Renaming a handheld does not affect student login information.

1. Right-click the handheld name in the Content pane.
2. Click **Rename**.
3. Type the new name.
4. Press **Enter** to go to the next name to change.

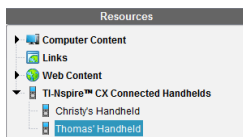

5. To exit the Edit mode, click an area of the screen outside the handheld names. You will also leave the Edit mode after you press **Enter** on the last name you edit.

## ***Using Identify Selected to Locate Handhelds***

If you are using the TI-Nspire™ Docking Station or the TI-Nspire™ CX Docking Station, use this feature to locate handhelds.

1. Be sure that the handhelds are turned on and that the docking station is connected to your computer.
2. Use the Workspace selector to select the Content Workspace.
3. Click **Tools > Identify Selected Handheld/Lab Cradle**.

**Note:** You can also right-click the handheld name in the Content pane, and then select **Identify Selected Handheld/Lab Cradle**.

Both LED lights on the docking station under the slot where the handheld is located will blink for 30 seconds.

## Using the Transfer Tool

When a class is not in session, you can transfer files or folders containing files from your computer to connected TI-Nspire™ handhelds using the Transfer Tool. With the Transfer Tool, you can transfer one or more files or documents to one or more handhelds without requiring students to log in.

Files	File Extensions
Operating systems (OS)	.tcc (TI-Nspire™ CX CAS handhelds) .tco (TI-Nspire™ CX handhelds) .tcc2 (TI-Nspire™ CX II CAS handhelds) .tco2 (TI-Nspire™ CX II handhelds) .tct2 (TI-Nspire™ CX II-T handhelds)
Documents	.tilb (TI-Nspire™ Lesson Bundle) .tns (TI-Nspire™ document)

### Notes:

- You can transfer more than one operating system file at a time; however, you can only transfer one operating system file with the same file extension at a time. For example, you can transfer a .tcc and a .tco file at the same time, but only one .tcc file at that time.

### Transfer Tool Interface

The Transfer Tool dialog box contains a Setup tab and a Status tab.

#### Setup Tab

The Setup tab allows you to select files to transfer and a destination folder.

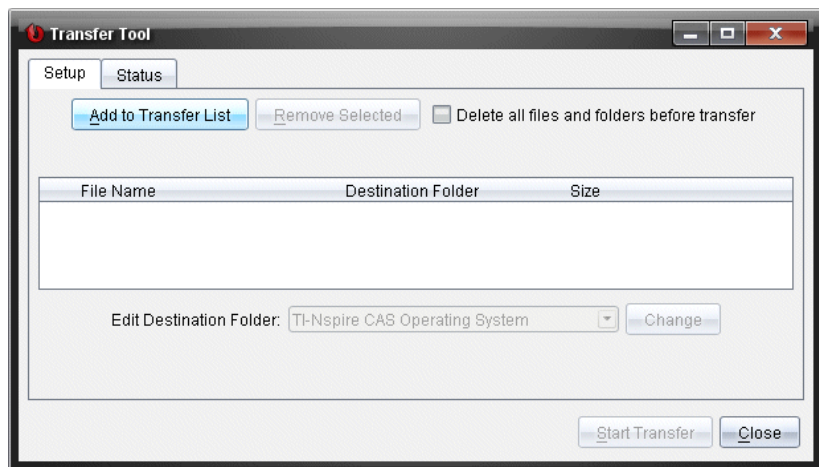

The Setup tab includes the following features:

Feature	Description
Add to Transfer List	Click to add files or folders with files to the Transfer List. The Transfer List displays the File Name (or folder name), the Destination Folder, and the Size (in KB) of the file or folder you want to transfer.
Remove Selected	Click to remove selected files and folders from the Transfer List. This option becomes active when you add files to the Transfer List.
Delete all files and folders before transfer	Select to clear all files and folders on a handheld before a file transfer.
Edit Destination Folder	Select to change the destination folder for the files you want to transfer.

### Status Tab

The Status tab is only active when a transfer is in progress.

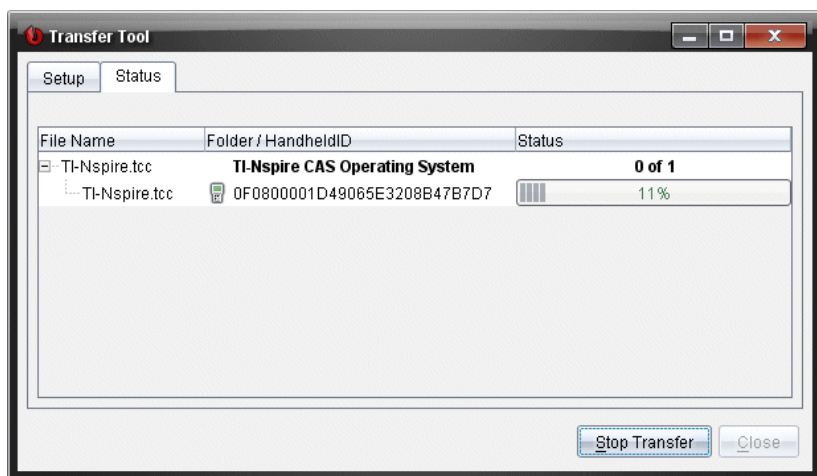

When you start a transfer, the Transfer Tool automatically switches to the Status tab. The Status tab allows you to view the progress and status of files as they transfer and provides the following information:

Information	Description
File Name	Indicates the file name and extension.
Folder/Handheld ID	Indicates the destination folder and the handheld ID.
Status	Indicates the completion status, the progress bar, or any error message. Error messages include: <ul style="list-style-type: none"> <li>• Low battery</li> <li>• Wrong handheld type</li> <li>• Memory full</li> <li>• Lost connectivity</li> </ul>

#### Notes:

- If no transfers are active, the following message is displayed: *“No transfers are active. Use the Setup tab to configure and start the transfer.”*
- During a transfer, no options are available on the Setup tab.

### ***Opening the Transfer Tool***

Before you can use the Transfer Tool, you must end any running class sessions.

To open the Transfer Tool, use one of these methods:

- ▶ Click **Tools > Transfer Tool**.
- ▶ Click , and then select **Send to Connected Handhelds**.

The Transfer Tool opens the Setup tab.

### ***Adding Files or Folders to the Transfer List***

You must add files or folders to the Transfer List before you can start a transfer.

**Note:** You can only add a folder that contains files to the Transfer List.

To add files or folders to the Transfer List:

1. In the Transfer Tool dialog box, click **Add to Transfer List**.

The Add to Transfer List dialog box opens.

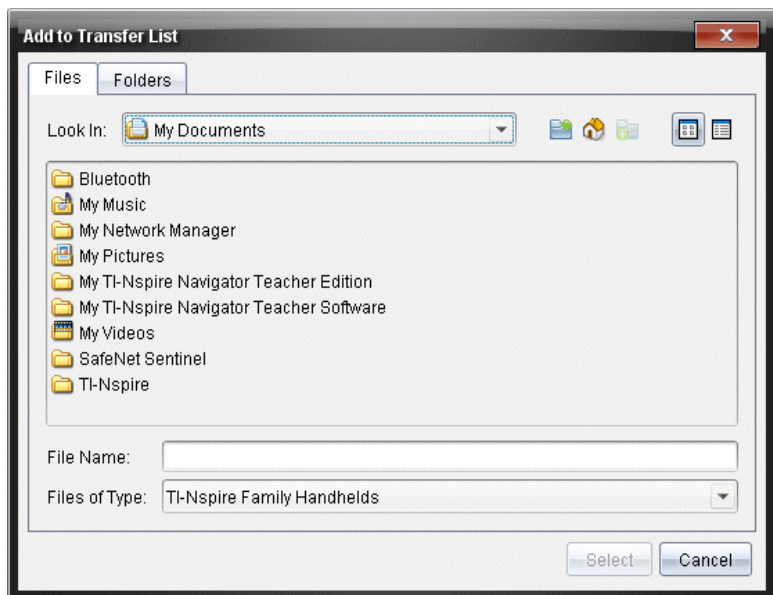

2. To add files to the Transfer List, navigate to the folder or folders that contain the files you want to transfer.
3. Click **Select** to add highlighted files to the Transfer list.
  - On the Files tab, you can see both files and folders, but you cannot select folders. You must drill down and select a file.
  - To select multiple files within a folder, press and hold the **Ctrl** key (Mac<sup>®</sup>: **⌘**) while selecting files.
4. To add folders containing files, click the Folders tab and navigate to the folder you want to select.
5. Click **Select** to add the highlighted folders.

**Note:** To select multiple folders, press and hold the **Ctrl** key (Mac<sup>®</sup>: **⌘**) while selecting folders.

Selected files and folders are displayed in the Transfer Tool dialog box.

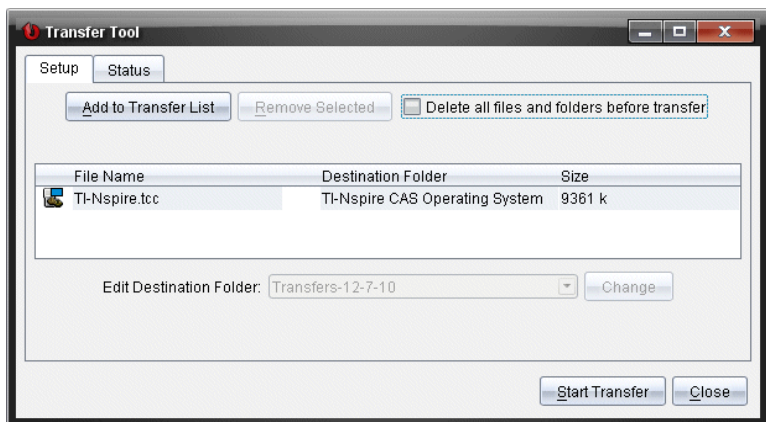

**Note:** You can only add one operating system file type to the Transfer List. If you attempt to add more than one operating system file type, the following error message is displayed.

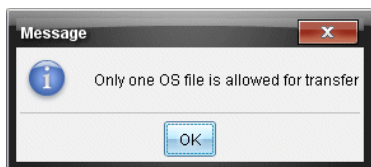

## ***Removing Files or Folders from the Transfer List***

You can remove files or folders that you no longer want to transfer.

To remove files or folders from the Transfer List, complete the following steps:

1. In the Transfer Tool dialog box, select files or folders you want to remove.

**Note:** To select multiple files or folders, press and hold the **Ctrl** key (Mac®: **⌘**) while selecting each file or folder.

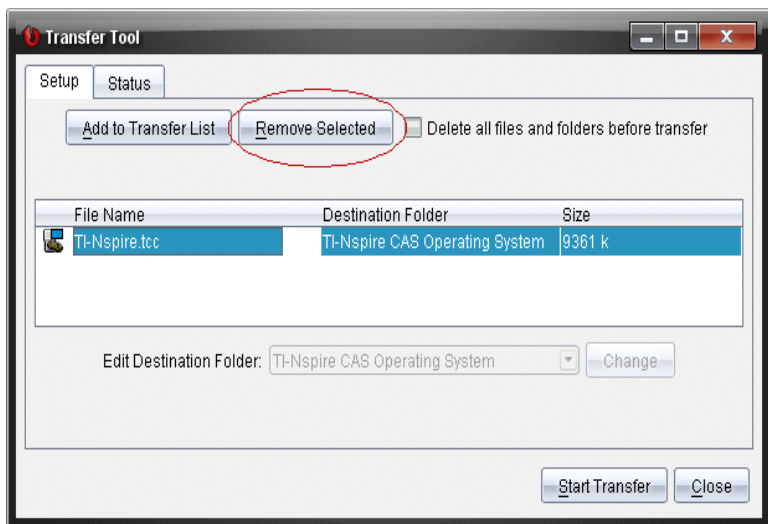

2. Click **Remove Selected**.

The files or folders are removed from the Transfer List.

### ***Editing the Destination Folder***

Except for an operating system file, you can change the destination folder for any file or folder in the Transfer List.

By default, the Transfer Tool creates the destination folder “*Transfer-date*.” The date format is based on the user’s preferred language setting and location. For example, the default date format for the United States is *mm-dd-yy*. If you change your preferred language setting, this default date format changes.

To change the destination folder:

1. Click a file or folder.
2. Complete one of the following actions:
  - From the **Edit Destination Folder** drop-down list, select the top level folder for any available handheld or any available folder.
  - In the **Edit Destination Folder** drop-down list, type a new destination folder name.



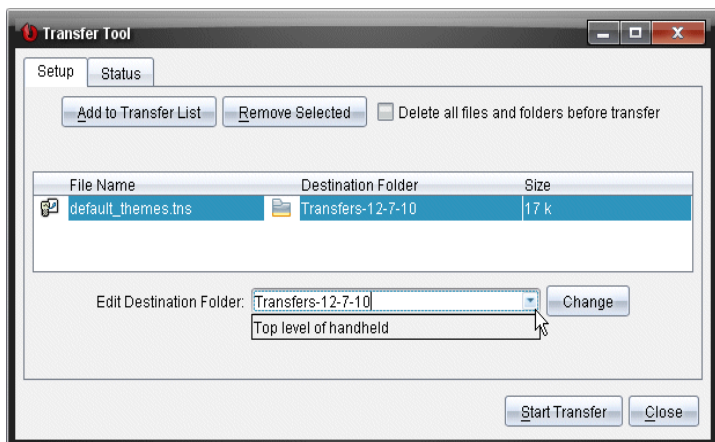

**Note:** Folder names can contain alphanumeric characters and can include slashes (/ and \). You cannot use double slashes (// and \\) and these special characters (? | : \* " " < > |).

3. Click **Change**.

The destination folder in the Transfer List changes for the files or folders you selected.

### ***Deleting All Handheld Files and Folders***

You can use the Transfer Tool to delete all files and folders on a connected handheld. Use this feature to delete existing files and folders to ensure that only the files you want students to work with are on the handhelds.

By default, the Transfer Tool disables this setting. If selected, the new setting becomes the default the next time you open Transfer Tool.

To delete all files and folders from a connected handheld:

1. In the Transfer Tool dialog box, select **Delete all files and folders before transfer**.

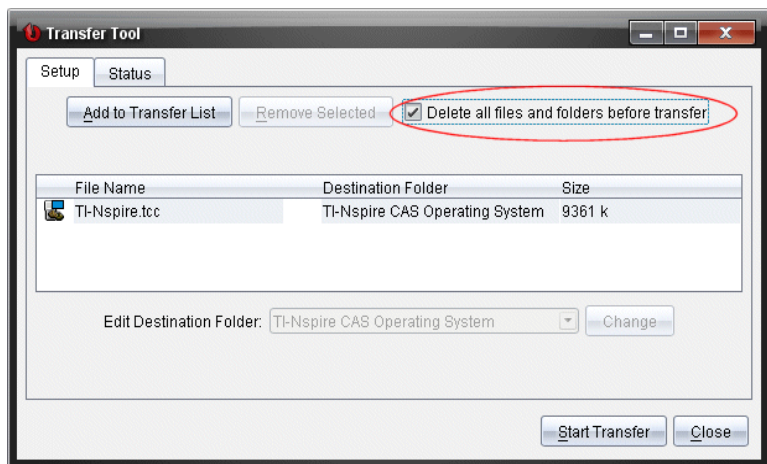

2. Click **Start Transfer**.

The Confirm dialog box opens.

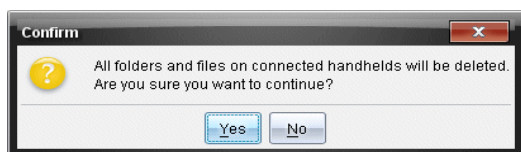

3. Click **Yes**.

The Transfer Tools displays the **Status** tab. This tab displays the status and progress as files are deleted.

## Starting a Transfer

After you have added all files and folders to the Transfer List and selected other options as necessary, you can start the transfer. You can transfer operating system files and documents at the same time.

To start a transfer:

1. Connect one or more TI-Nspire™ handhelds.

If handhelds are not connected, the **Status** tab indicates “*No Active Connected Handhelds*” when you start a transfer.

2. From the Resources pane, complete one of the following actions:
  - To transfer files to one or more TI-Nspire™ handhelds, select the individual handhelds.
  - To transfer files to all connected TI-Nspire™ handhelds, select Connected Handhelds (top level).

3. In the Transfer Tool dialog box, click **Start Transfer**.

The Transfer Tool dialog box switches to the **Status** tab and displays the transfer information.

- The progress bar disappears when a transfer is complete.
- During a transfer, the Transfer Tool indicates which handhelds are connected and successfully received files.
- If a handheld disconnects and then reconnects during a transfer, the Transfer Tool indicates the status of completed transfers, and resumes transferring other files as necessary.

## ***Stopping File Transfers***

You can stop a file transfer at any time.

To stop a file transfer:

1. In the Transfer Tool, click **Stop Transfer**.

The Confirm dialog box opens.

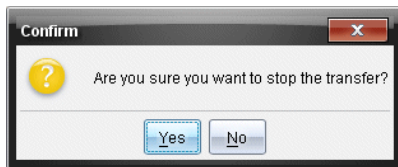

2. Click **Yes**.

The Transfer Tool stops transferring and displays the **Setup** tab.

- If a connected handheld has already received files, those files remain on the handhelds.
- Files remain in the **Setup** tab until you close the Transfer Tool, or until you delete them.

## ***Closing the Transfer Tool***

When you have completed transferring files and folders, close the Transfer Tool.

- ▶ To close the Transfer Tool, click **Close**.
  - You cannot close the Transfer Tool if a transfer is active.
  - When closed, the Transfer Tool clears files and folders you added to the Transfer List.
  - When closed, the Transfer Tool keeps the last **Delete all files and folders before transfer** setting.

# Using the Documents Workspace

Use this workspace to create, modify, and view TI-Nspire™ documents, and to demonstrate mathematical concepts.

## Exploring the Documents Workspace

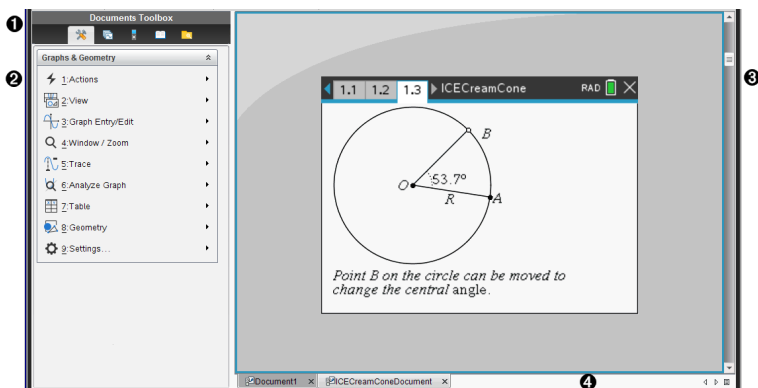

- 1 Documents Toolbox.** Contains tools such as the Document Tools menu, Page Sorter, TI-SmartView™ emulator, Utilities, and Content Explorer. Click each icon to access the available tools. When you are working in a TI-Nspire™ document, the tools available are specific to that document.
- 2 Toolbox pane.** Options for the selected tool are displayed in this area. For example, click the Document Tools icon to access tools needed to work with the active application.  
**Note:** In the TI-Nspire™ CX Premium Teacher Software, the tool for configuring questions opens in this space when you insert a question. For more information, see *Using Question in the Teacher Software*.
- 3 Work area.** Shows the current document and enables you to perform calculations, add applications, and add pages and problems. Only one document at a time is active (selected). Multiple documents appear as tabs.
- 4 Document information.** Shows the names of all open documents. When there too many open documents to list, click the forward and backward arrows to scroll through the open documents.

## Using the Documents Toolbox

The Documents Toolbox, located on the left side of the workspace, contains tools needed for working with TI-Nspire™ documents. When you click a toolbox icon, the associated tools appear in the Toolbox pane.

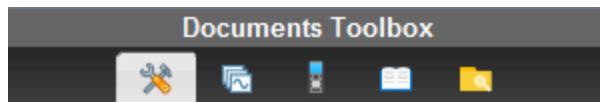

## Exploring Document Tools

In the following example, the Document Tools menu is open showing the options for the Calculator application. In TI-Nspire™ documents, the Document Tools menu contains tools available for working with an application. The tools are specific to the active application.

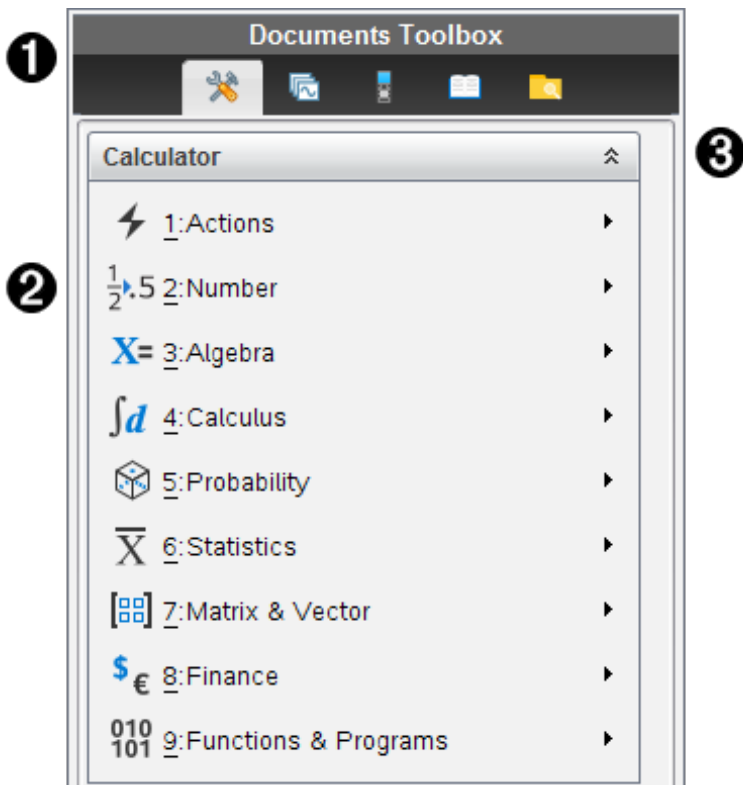

- 1 The Documents Toolbox menu.
- 2 Tools available for the Calculator application. Click ▶ to open the submenu for each option.
- 3 Click ⤴ to close and click ⤵ to open Document Tools.

## Exploring the Page Sorter

The following example shows the Documents Toolbox with the Page Sorter open. Use the Page Sorter to:

- See the number of problems in your document and where you are.

- Move from one page to another by clicking the page you want.
- Add, cut, copy, and paste pages and problems within the same document or between documents.

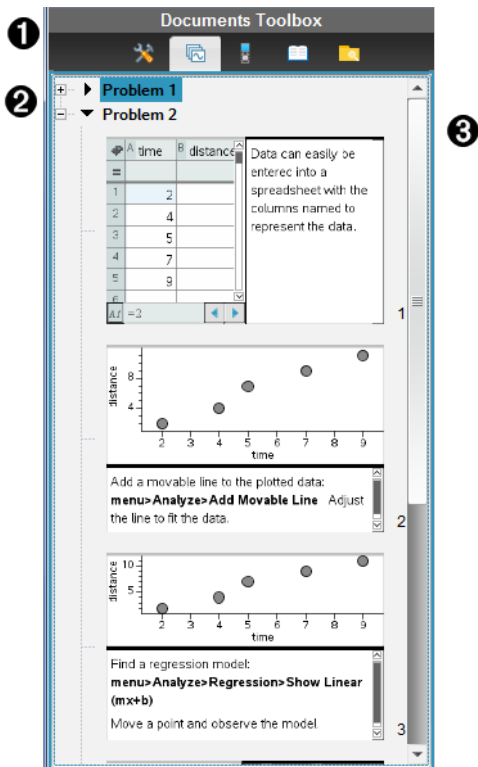

- 1 The Documents Toolbox menu.
- 2 Click the minus sign to collapse the view. Click the + sign to open the view and show pages in the document.
- 3 Scroll bar. The scroll bar is only active when there are too many pages to show in the pane.

## Exploring the TI-SmartView™ Feature

The TI-SmartView™ feature emulates how a handheld works. In the teacher software, the emulated handheld facilitates classroom presentations. In the student software, the emulated keypad gives students the ability to drive the software as if using a handheld.

**Note:** Content is displayed on the TI-SmartView™ small screen only when the document is in Handheld view.

**Note:** The following illustration shows the TI-SmartView™ panel in the teacher software. In the Student Software, only the keypad is shown. For more information, see Using the TI-SmartView™ Emulator.

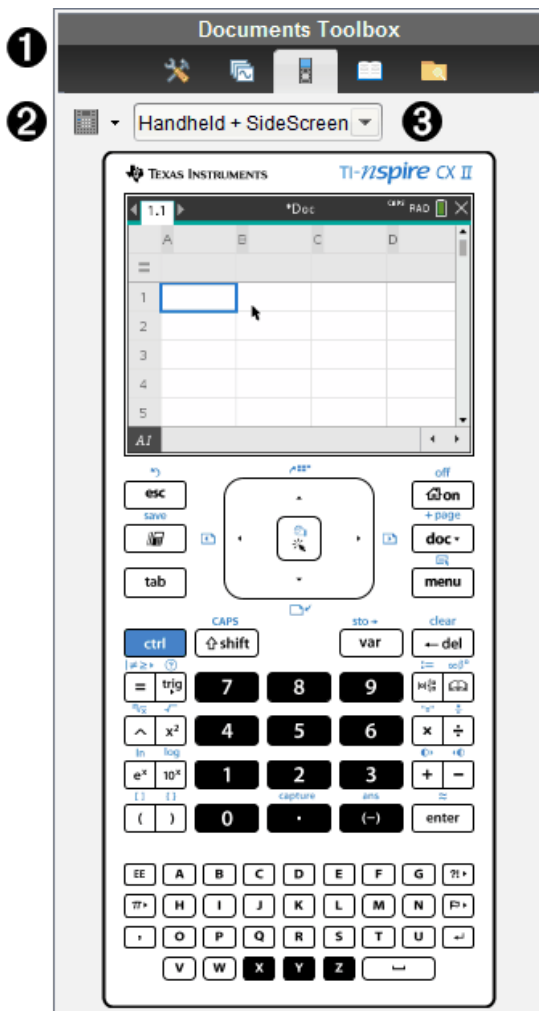

- 1 The Documents Toolbox menu.
- 2 Keypad Options. Click ▼ to select how to show the handheld:
  - Dark
  - Light
  - Outline

③ View selector. In the teacher software, click ▼ to select the handheld view:

- Handheld Only
- Keypad + SideScreen
- Handheld + SideScreen

**Note:** You can also change these options in the TI-SmartView™ Options window. Click **File > Settings > TI-Smartview™ Options** to open the window.

**Note:** The view selector is not available in the student software.

When the Handheld Only display is active, select **Always in Front** to keep the display in front of all other open applications. (Teacher software only.)

## ***Exploring Content Explorer***

Use Content Explorer to:

- See a list of files on your computer.
- Create and manage lesson bundles.
- If using software that supports connected handhelds, you can:
  - See a list of files on any connected handheld.
  - Update the OS on connected handhelds.
  - Transfer files between a computer and connected handhelds.

**Note:** If you are using TI-Nspire™ software that does not support connected handhelds, the Connected Handheld heading is not shown in the Content Explorer pane.



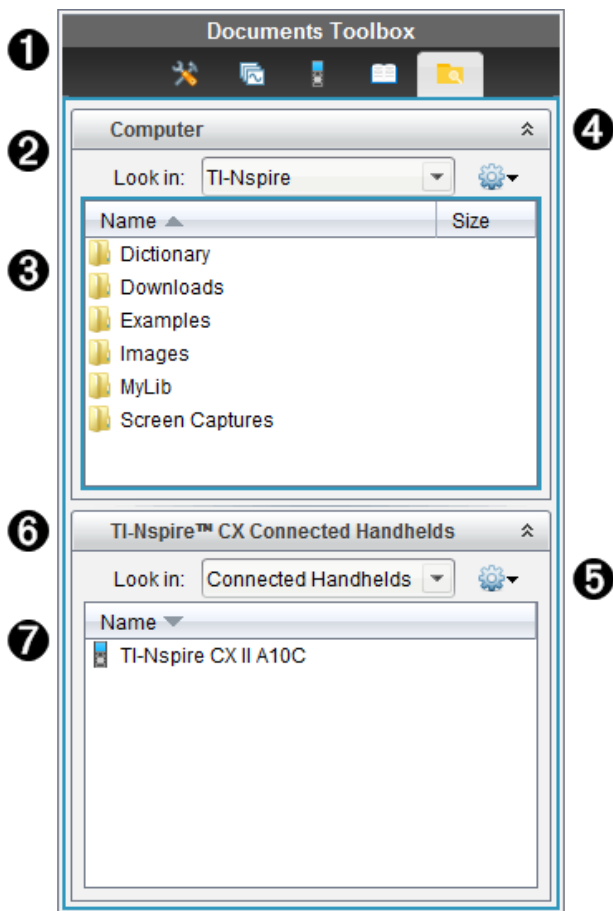

- 1 The Documents Toolbox menu.
- 2 Shows files on your computer and the name of the folder where the files are located. Click ▼ to navigate to another folder on the computer.
- 3 The list of folders and files within the folder named in the **Look In:** field. Right-click on a highlighted file or folder to open the context menu listing available actions for that file or folder.
- 4 Click ▲ to close the list of files. Click ▼ to open the list of files.
- 5  Options menu. Click ▼ to open the menu of actions you can perform on a selected file:
  - Open an existing file or folder.
  - Move (navigate) up one level in the folder hierarchy.

- Create a new folder.
  - Create a new lesson bundle.
  - Rename a file or folder.
  - Copy selected file or folder.
  - Paste file or folder copied to Clipboard.
  - Delete selected file or folder.
  - Select all files in a folder.
  - Package lesson bundles.
  - Refresh the view.
  - Install OS.
- 6 Connected handhelds. Lists the connected handhelds. Multiple handhelds are listed if more than one handheld is connected to the computer or when using the TI-Nspire™ Docking Stations.
- 7 The name of the connected handheld. To show the folders and files on a handheld, double-click the name.
- Click ▼ to navigate to another folder on the handheld.

## ***Exploring Utilities***

Utilities provides access to the math templates and operators, special symbols, catalog items, and libraries that you need when working with documents. In the following example, the Math templates tab is open.

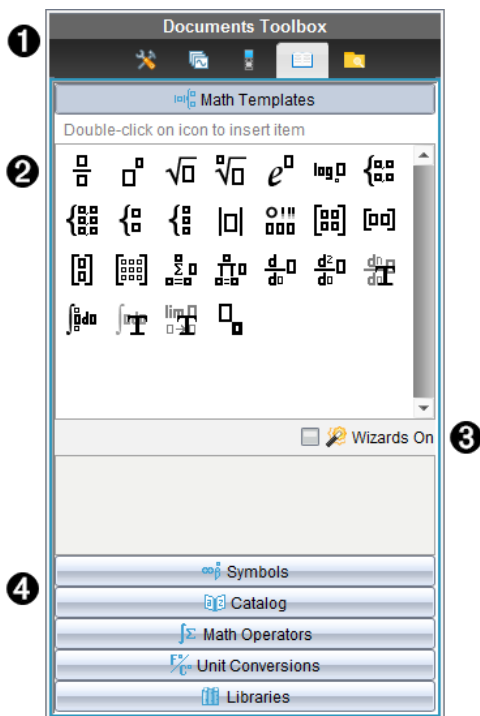

- 1 The Documents Toolbox menu.
- 2 Math Templates are open. Double-click a template to add it to a document. Click the Math Template tab to close the template view.  
To open the Symbols, Catalog, Math Operators, and Libraries, click the tab.
- 3 Wizards On check box. Select this option to use a wizard to enter function arguments.
- 4 Tabs for opening views where you can select and add symbols, catalog items, math operators, and library items to a document. Click the tab to open the view.

## Using the Work Area

The space on the right side of the workspace provides an area for creating and working with TI-Nspire™ documents. This work area provides a view of the document so that you can add pages, add applications, and perform all work. Only one document at a time is active.

When you create a document, you specify its page size as Handheld or Computer. This is how the page is displayed in the work area.

- **Handheld** page size is optimized for the smaller screen of a handheld. This page size can be viewed on handhelds, computer screens, and tablets. The content is scaled when viewed on a larger screen.

- **Computer** page size takes advantage of the larger space of a computer screen. These documents can show details with less scrolling required. The content is not scaled when viewed on a handheld.

You can change the page preview to see how the document will look in a different page size.

- ▶ To change the page preview, click **Document Preview** on the toolbar, and then click **Handheld** or **Computer**.



For more information on page size and document preview, see *Working with TI-Nspire™ Documents*.

## Changing Document Settings

Document settings control how all numbers, including elements or matrices and lists, are displayed in TI-Nspire™ documents. You can change the default settings at anytime and you can specify settings for a specific document.

### Changing Document Settings

1. Create a new document or open an existing document.
2. From the TI-Nspire™ **File** menu, select **Settings > Document Settings**.

The Document Settings dialog box opens.

When you open Document Settings the first time, the default settings are displayed.

3. Press **Tab** or use your mouse to move through the list of settings. Click ▼ to open the drop-down list to view the available values for each setting.

Field	Values
Display Digits	<ul style="list-style-type: none"> <li>• Float</li> <li>• Float1 - Float12</li> <li>• Fix0 - Fix12</li> </ul>
Angle	<ul style="list-style-type: none"> <li>• Radian</li> <li>• Degree</li> <li>• Gradian</li> </ul>
Exponential Format	<ul style="list-style-type: none"> <li>• Normal</li> <li>• Scientific</li> <li>• Engineering</li> </ul>
Real or	<ul style="list-style-type: none"> <li>• Real</li> </ul>

Field	Values
Complex	<ul style="list-style-type: none"> <li>• Rectangular</li> <li>• Polar</li> </ul>
Calculation Mode	<ul style="list-style-type: none"> <li>• Auto</li> <li>• Exact</li> <li>• Approximate</li> </ul> <p><b>Note:</b> Auto mode shows an answer that is not a whole number as a fraction except when a decimal is used in the problem. Exact mode (CAS only) shows an answer that is not a whole number as a fraction or in symbolic form, except when a decimal is used in the problem.</p>
Exact Arithmetic	<ul style="list-style-type: none"> <li>• On</li> <li>• Off</li> </ul> <p><b>Note:</b> This option is only available on Exact Arithmetic handhelds.</p>
CAS Mode	<ul style="list-style-type: none"> <li>• On</li> <li>• Exact Arithmetic</li> <li>• Off</li> </ul> <p><b>Note:</b> This option is only available on CAS handhelds and software.</p>
Vector Format	<ul style="list-style-type: none"> <li>• Rectangular</li> <li>• Cylindrical</li> <li>• Spherical</li> </ul>
Base	<ul style="list-style-type: none"> <li>• Decimal</li> <li>• Hex</li> <li>• Binary</li> </ul>
Unit System	<ul style="list-style-type: none"> <li>• SI</li> <li>• Eng/US</li> </ul> <p><b>Note:</b> This option is only available on CAS handhelds and software.</p>

4. Click the desired setting.

5. Choose one of the following options:

- To apply the settings to the open document and to Scratchpad, and to make default for new applications, click **OK**.
- Click **Cancel** to close the dialog box without making changes.

## Changing Graphs & Geometry Settings

Graphs & Geometry settings control how information is displayed in open problems and in subsequent new problems. When you change the Graphs & Geometry settings, the selections become the default settings for all work in these applications.

Complete the following steps to customize the application settings for graphs and geometry.

1. Create a new graphs and geometry document or open an existing document.
2. In the Documents Toolbox, click  to open the Graphs & Geometry application menu.
3. Click **Settings > Settings**.

The Graphs & Geometry Settings dialog box opens.

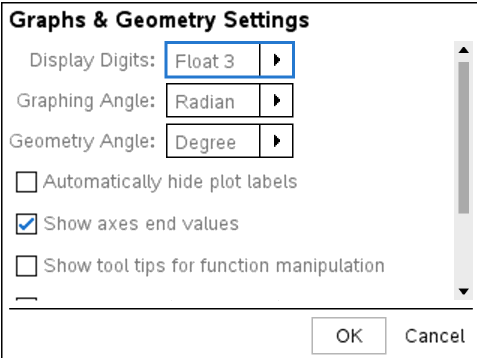

**Graphs & Geometry Settings**

Display Digits:

Graphing Angle:

Geometry Angle:

Automatically hide plot labels

Show axes end values

Show tool tips for function manipulation

OK Cancel

4. Press **Tab** or use your mouse to move through the list of settings. Click **▶** to open the drop-down list to view the available values for each setting.

Field	Values
Display Digits	<ul style="list-style-type: none"><li>• Auto</li><li>• Float</li><li>• Float1 - Float12</li><li>• Fix0 - Fix12</li></ul>
Graphing Angle	<ul style="list-style-type: none"><li>• Auto</li><li>• Radian</li><li>• Degree</li><li>• Gradian</li></ul>
Geometry Angle	<ul style="list-style-type: none"><li>• Auto</li><li>• Radian</li><li>• Degree</li><li>• Gradian</li></ul>

5. Select the desired setting.
6. Select a check box to enable an option or clear a check box to disable an option.

Check box	Operation when selected
Automatically hide plot labels	Plot labels are displayed only when selected, grabbed, or hovered.
Show axis end values	A numeric label is displayed at the least and greatest values visible on an axis
Show tool tips for function manipulation	Shows helpful information as you manipulate function graphs
Automatically find a point of interest	Shows zeros, minima, and maxima for graphed functions and objects while tracing function graphs.

7. Choose one of the following options:
  - To apply the settings to the open document and to Scratchpad, and to make default for new Graphs and Geometry applications, click **OK**.
  - Click **Cancel** to close the dialog box without making changes.

# Working with TI-Nspire™ Documents

All work that you create and save using TI-Nspire™ applications is stored as a document (.tns file), which you can share with others using TI-Nspire™ software and with those using handhelds.

## TI-Nspire™ Documents

A TI-Nspire™ document consists of one or more problems. Each problem can contain one or more pages. A single page is displayed in the work area. All work occurs in the applications within pages.

Because the TI-Nspire™ software and handhelds share the same functionality, you can transfer TI-Nspire™ documents between computers and handhelds. When you create a document, you select one of two page sizes.

- **Handheld.** Size: 320 × 217 pixels. This size allows documents to be viewed on all platforms. The content will be scaled when viewed on a tablet or larger screen.
- **Computer.** Size: 640 × 434 pixels. The content will not be scaled when viewed on smaller platforms. Some content may not be visible on a handheld device.

You can convert a document from one page size to the other anytime.

## Creating a New TI-Nspire™ Document

When you open the software, the Documents Workspace opens with a blank document containing one problem. You can add applications and content to this problem to create a document.

**Note:** The Welcome Screen is displayed when you open the software if the "always show this at startup" option is selected. Click an application icon to add a problem with an active application to a new document.

To create a new document, complete the following steps:

1. On the TI-Nspire™ **File** menu,
  - Select **New TI-Nspire™ Document - Handheld Page Size**.
  - or—
  - Select **New TI-Nspire™ Document - Computer Page Size**.

The new document opens in the Documents Workspace, and you are prompted to select an application.



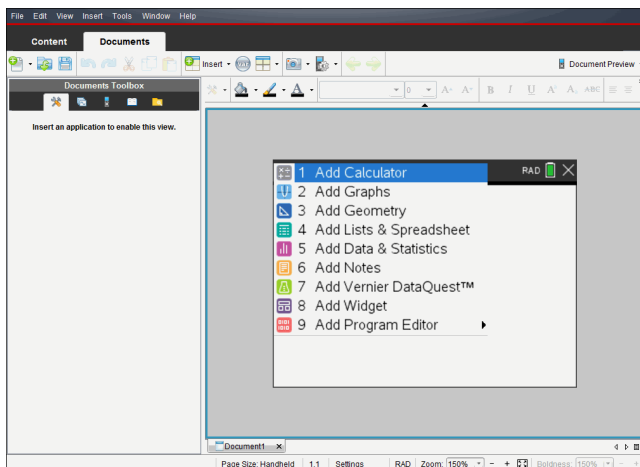

2. Select an application to add a problem to the document.

The problem is added to the document.

## ***Opening an Existing Document***

To open an existing document:

1. Click **File > Open Document**.

—or—



Click

The Open dialog box opens.

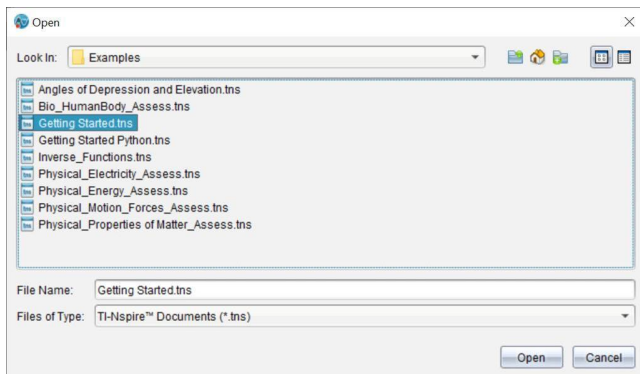

2. Use the file browser to locate the file you want to open and click the file to select it.
3. Click **Open**.

The document opens in the work area.

**Note:** To select from your 10 most recent documents, click **File > Recent Documents** and select a document from the drop-down list.

## ***Saving TI-Nspire™ Documents***

To save a new document:

1. Click **File > Save Document** or click .

The Save TI-Nspire™ Document dialog box opens.

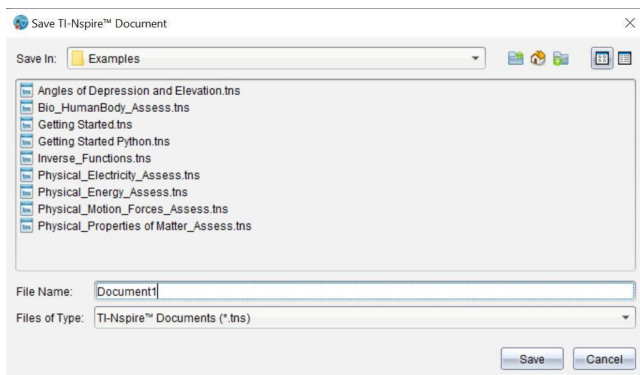

2. Navigate to the folder where you want to save the document or create a folder in which to store the document.
3. Type a name for the new document.
4. Click **Save** to save the document.

The document closes and is saved with the extension .tns.

**Note:** When you save a file, the software looks in the same folder the next time you open a file.

### **Saving a Document with a New Name**

To save a previously saved document in a new folder and/or with a new name:

1. Click **File > Save As**.

The Save TI-Nspire™ Document dialog box opens.

2. Navigate to the folder where you want to save the document or create a folder in which to store the document.
3. Type a new name for the document.
4. Click **Save** to save the document with a new name.

## Deleting Documents

File deletions on your computer are sent to the Recycle bin and can be retrieved if the Recycle bin has not been emptied.

**Note:** File deletions on the handheld are permanent and cannot be undone, so be sure that you want to delete the file that you select.

1. Select the document you want to delete.
2. Click **Edit > Delete** or press **Delete**.

The Warning dialog box opens.

3. Click **Yes** to confirm the delete.

The document is deleted.

## Closing Documents

- ▶ To close a document, click **File > Close** or click the **Close** icon on the document tab at the bottom of the document.











- ▶ If working in tiled view, click the **Close** icon in the upper right corner of the document window.

## Formatting Text in Documents

Use the text formatting tools to format text in TI-Nspire™ applications that allow formatted text. By default, the text formatting toolbar opens in the area above an active document. Options on the toolbar are enabled or disabled depending on the active application.

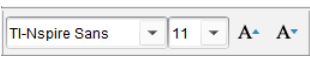

Option	Function
	Click ▼ to open the menu for the active application. This tool enables you to open an application menu regardless of the option selected in the Documents Toolbox.
	Click ▼ to select a background color for highlighting text or choose a fill color for a selected cell.

Option	Function
	Click ▼ to select the line color for an object. For example, in Graphs & Geometry, you can choose a color for a selected shape.
	Click ▼ to select a color for selected text.
	Use these tools to choose a font and set the size of the font. <ul style="list-style-type: none"> <li>Click ▼ to select a different font from the drop-down box.</li> <li>To select a specific font size, click ▼ to select a size from the drop-down box.</li> <li>Click  to increase the font size or click  to decrease the font size incrementally.</li> </ul>
	Click the appropriate tool to apply bolding, italics, or underlining; apply superscript or subscript; or strike out text.

### Hiding and Showing the Formatting Toolbar

- ▶ When the formatting toolbar is visible, click ▲ (located under the toolbar) to hide the toolbar.
- ▶ Click ▼ to show the toolbar when the formatting toolbar is hidden.

### Using Colors in Documents

In the TI-Nspire™ applications that allow formatting, you can use color in filled areas of an object, or in lines or text, depending on the application you are using and how you have selected the item. If the icon or menu item that you want to use is not available (dimmed) after you have selected an item, color is not an option for the selected item.

Colors appear in documents opened on your computer and on the TI-Nspire™ CX handheld. If a document containing color is opened on a TI-Nspire™ handheld, colors are displayed in shades of gray.

**Note:** For more information about using color in a TI-Nspire™ application, see the chapter for that application.

### Adding Color from a List

To add color to a fill area, line, or text, complete the following steps:

1. Select the item.

2. Click **Edit > Color** or select where you want to add color (fill, line, or text).
3. Select the color from the list.

### **Adding Color from a Palette**

To add color using the palette, complete the following steps:

1. Select the object.
2. Click the appropriate toolbar icon.
3. Select the color from the palette.

### **Setting Page Size and Document Preview**

When you create a document, you specify its page size as Handheld or Computer, depending on how you expect the document to be used. Documents of both page sizes can be opened on either platform, and you can convert the page size anytime.

- **Handheld.** Size:  $320 \times 217$  pixels, fixed. Handheld documents can be viewed on all platforms. You can magnify (zoom) the content when viewing it on a tablet or larger screen.
- **Computer.** Size:  $640 \times 434$  pixels, minimum. Computer documents scale up automatically to take advantage of higher resolution screens. The minimum size is  $640 \times 434$ , so some content may be clipped on handheld devices.

**Note:** You can view documents of either page size using Handheld or Computer preview.

#### **Converting the Current Document's Page Size**

- ▶ On the main TI-Nspire™ **File** menu, select **Convert to**, and then select the page size.  
The software saves the current document and creates a copy that uses the requested page size.

#### **Viewing the Document in Handheld Preview**

1. On the application toolbar, click **Document Preview**, and select **Handheld**.  
The preview changes. This does not change the document's underlying page size.
2. (Optional) Adjust the viewing magnification:
  - Click the **Zoom** tool beneath the work area, and select a magnification value.  
—or—
  - Click the **Zoom to Fit** button  to make the handheld preview adjust automatically to the window size.

## Viewing the Document in Computer Preview

1. On the application toolbar, click **Document Preview**, and select **Computer**.

The preview changes. This does not change the document's underlying page size.

2. (Optional) Click the **Boldness** tool beneath the work area, and select a value to increase or decrease the boldness of text and other items.

## Setting the Default Page Size for New Documents

1. On the main TI-Nspire™ **File** menu, select **Settings > Page Size Settings**.
2. Select a default page size, either Handheld or Computer.

The new size applies to documents that you create (Windows®: **Ctrl+C**, Mac®: **Cmd+C**) after setting the default, including the blank document created automatically each time you open the software. Changing the default setting does not convert any currently open documents or other existing documents.

## Setting a Default Preview

By default, when you open a document, it is automatically displayed using the preview that matches its page size. You can override this rule and specify a preview that you prefer.

1. On the main TI-Nspire™ **File** menu, select **Settings > Preview Settings**.
2. Select the preview that you want documents to use when you open them.

## Working with Multiple Documents

When multiple documents are open, document names are listed in tabs at the bottom of the work area. Only one document is active at a time, and only the active document is affected by commands from menus or tools.

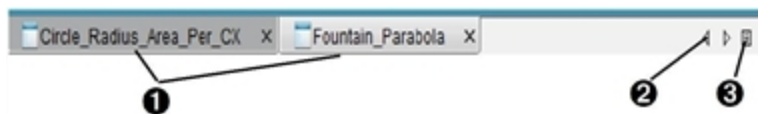

To switch between documents:

1. Click the tab to show a document in the work area. This document becomes the active document. If the Show Documents in Tiles view is open, these tabs are not shown.
2. Use the right and left arrows to scroll through the list of documents. These arrows are active only when there are too many documents to fit in the window.

- 3 Click the Show List icon to list all open documents. This is useful when you have a large number of documents open and documents names on the tabs may be truncated.

### Working with Multiple Documents in Tiled View

When multiple documents are open, you can view thumbnails of the documents in the work area. To change the view:

- Click **Window > Show Documents in Tiles**.

Open documents are shown as thumbnails in the work area, and the scroll bar becomes active.

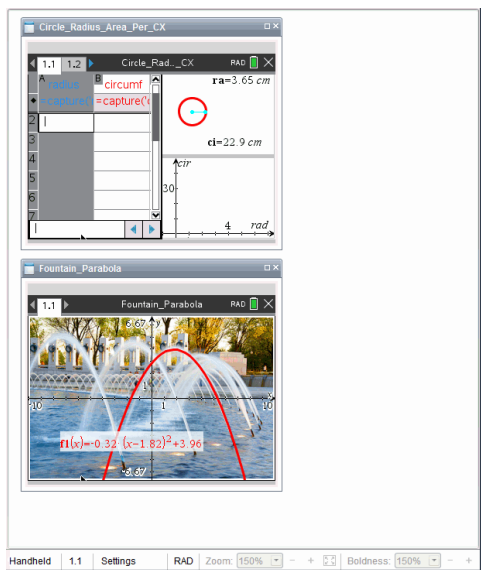



The status bar remains available; however, document names now appear in the thumbnail view. Click **Select Window > Show Documents in Tabs** to view one document at a time in the work area.

### Working with Applications

When you first open a new document or add a new problem to a document, you select an application from a menu.

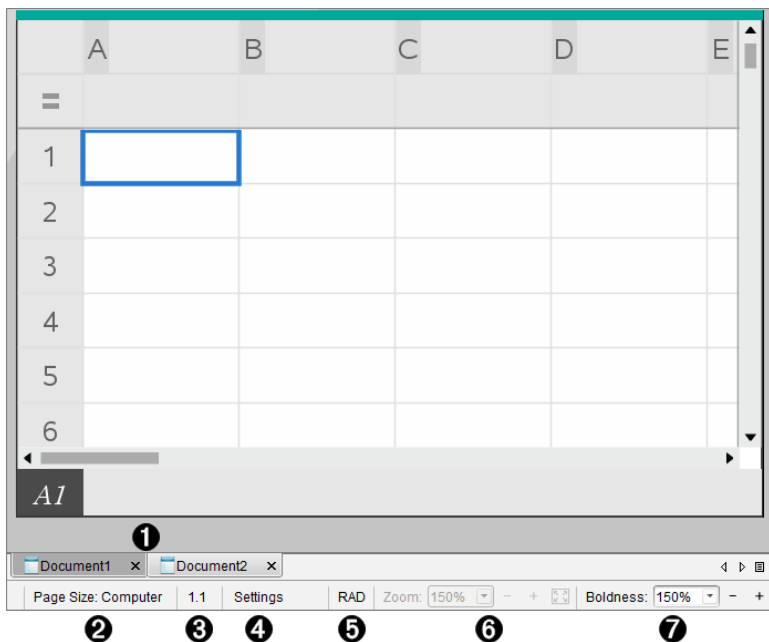
The following illustration shows how a document containing the Lists & Spreadsheet application appears in the work area.



- ❶ **Document name.** Tabs show the names of open documents. Click a name to make it the active document.
- ❷ **Page Size.** Shows the document's page size as Handheld or Computer. You can use the TI-Nspire™ **File** menu to convert a document from one page size to the other.
- ❸ **Problem/Page counter.** Labels the problem number and page number of the active page. For example, a label of **1.2** identifies Problem 1, Page 2.
- ❹ **Settings.** Double-click to view or change the Document Settings for the active document or to change the default Document Settings.
- ❺ **Angle Mode.** Shows an abbreviation of the angle mode (Degrees, Radians, or Gradians) in effect. Hover the pointer over the indicator to see the full name.
- ❻ **Zoom.** Enabled in Handheld preview only (click **Document Preview** on the toolbar and select **Handheld**). Click ▼ and select a magnification value, or click the zoom-to-fit button  to make the preview adapt automatically to window size.
- ❼ **Boldness.** Enabled in Computer preview only (click **Document Preview** on the toolbar and select **Computer**). Click ▼ and select a value to increase or decrease the boldness of text and other items.

### Working with Multiple Applications on a Page

You can add up to four applications to a page. When you have multiple applications on a page, the menu for the active application is displayed in the Documents Toolbox. Using multiple applications involves two steps:

- Changing the page layout to accommodate multiple applications.



- Adding the applications.

You can add multiple applications to a page even if an application is already active.

### Adding Multiple Applications to a Page

By default, each page contains space to add one application. To add additional applications to the page, complete the following steps.

1. Click **Edit > Page Layout > Select Layout**.

—or—

Click  .

The page layout menu opens.



There are eight page layout options available. If an option is already selected, it is dimmed.

2. Highlight the layout you want to add to the problem or page, and then click to select it.

The new layout is displayed with the first application active.

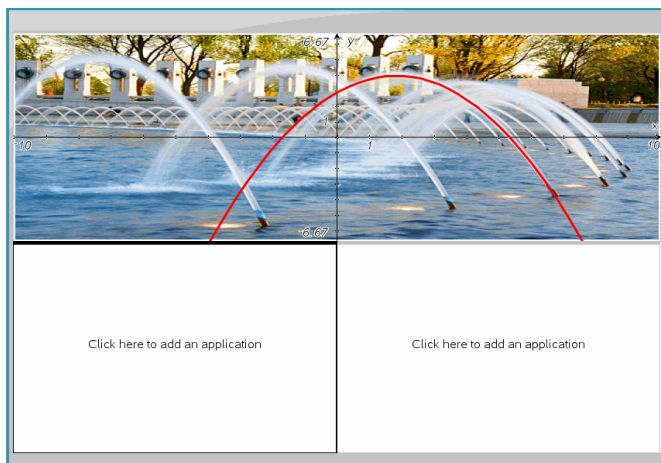

3. In Handheld preview, click **Press menu** to select an application for each new section in the problem or page. In Computer view, select **Click here to add an application**.

### Swapping Applications

To change the position of applications on a page with multiple applications, “swap” the positions of two applications.

1. Click **Edit > Page Layout > Swap Application**.

**Note:** The last active application you worked on is automatically selected as the first application to be swapped.

2. Click the second application to swap.

This action performs the swap.

**Note:** When there are only two work areas, the selected application automatically swaps position with the other application in the work area.

To cancel a swap, press **Esc**.

### Selecting and Moving Pages

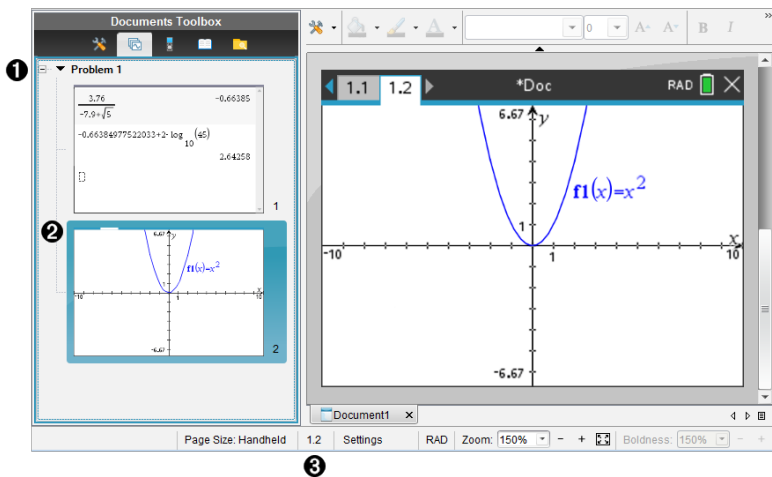

As you add problems and pages to a document, you can take advantage of features for managing the parts.



- ❶ **Page Sorter.** Lists the problems you have inserted in your document and shows thumbnail images of the pages in each problem. The Page Sorter lets you rearrange, copy, and move both problems and pages. It also lets you rename problems.
- ❷ **Active page.** Indicates the current page by highlighting its thumbnail image. Thumbnails let you easily scan the pages in a document and select a specific page to work with.
- ❸ **Problem/Page counter.** Displays the problem number and page number of the currently selected page.

## Selecting Pages

Use any of these methods to move from page to page.

- ▶ On the **View** menu, select **Previous Page** or **Next Page**.
- ▶ On the keyboard, press **Ctrl+PgUp** or **Ctrl+PgDn**.  
(Mac®: Press **Fn+Up Arrow** or **Fn+Down Arrow**).
- ▶ Click the Previous Page  or Next Page  button on the main toolbar.
- ▶ Click the Page Sorter tool  in the Documents Toolbox, and then click the thumbnail of the page you want to work with.

**Tip:** To expand or collapse the list of thumbnails for a problem, double-click the name of the problem.

## Rearranging Pages with the Page Sorter

The Page Sorter makes it easy to reorder pages within a problem.

1. If necessary, click the Page Sorter tool  in the Documents Toolbox.
2. In the Page Sorter, drag the thumbnail image of the page to the desired position.

### **Copying a Page**

You can copy a page within the same problem or copy it to a different problem or document.

1. If necessary, click the Page Sorter tool  in the Documents Toolbox.
2. Select the thumbnail of the page to be copied.
3. On the **Edit** menu, click **Copy**.
4. Click the location at which you want to insert the copy.
5. On the **Edit** menu, click **Paste**.

### **Moving a Page**

You can move a page within the same problem or move it to a different problem or document.

1. If necessary, click the Page Sorter tool  in the Documents Toolbox.
2. Select the thumbnail of the page to be moved.
3. On the **Edit** menu, click **Cut**.
4. Click the new location of the page.
5. On the **Edit** menu, click **Paste**.

### **Deleting a Page**

1. Select the page in the work area or in the Page Sorter.
2. Click **Edit > Delete**.

### **Grouping Applications on a Page**

You can combine as many as four consecutive application pages into a single page.

1. Select the first page in the series.
2. Click **Edit > Page Layout > Group**.

The next page is grouped with the first page. The page layout automatically adjusts to display all the pages in the group.

## Ungrouping Applications into Separate Pages

1. Select the grouped page.
2. Click **Edit > Page Layout > Ungroup**.

The applications are divided into individual pages.

## Deleting an Application from a Page

1. Click the application to be deleted.
2. Click **Edit > Page Layout > Delete Application**.

**Tip:** To undo the delete, press **Ctrl + Z** (Mac®: **⌘ + Z**).

## Working with Problems and Pages

When you create a new document, it consists of a single problem with a single page. You can insert new problems and add pages to each problem.

### Adding a Problem to a Document

A document can contain up to 30 problems. Each problem's variables are unaffected by the variables in other problems.

- ▶ On the **Insert** menu, select **Problem**.

—or—

Click the Insert tool  on the main toolbar, and select **Problem**.

A new problem with an empty page is added to your document.

### Adding a Page to the Current Problem

Each problem can contain up to 50 pages. Each page has a work area, where you can perform calculations, create graphs, collect and plot data, or add notes and instructions.

1. Click **Insert > Page**.

—or—

Click the Insert tool  on the main toolbar, and select **Page**.

An empty page is added to the current problem, and you are prompted to choose an application for the page.

2. Select an application to add to the page.

## Renaming a Problem

New problems are named automatically as Problem 1, Problem 2, and so on. To rename a problem:

1. If necessary, click the Page Sorter tool  in the Documents Toolbox.
2. Click the problem name to select it.
3. On the **Edit** menu, click **Rename**.
4. Type the new name.

## Rearranging Problems with the Page Sorter

The Page Sorter lets you reorder problems within a document. If you move a problem that you have not renamed, the numeric part of the default name changes to reflect the new position.

1. If necessary, click the Page Sorter tool  in the Documents Toolbox.
2. In the Page Sorter, arrange the problems by dragging each problem name to its new position.

**Tip:** To collapse a problem's list of page thumbnails, double-click the name of the problem.

## Copying a Problem

You can copy a problem within the same document or copy it to a different document.

1. If necessary, click the Page Sorter tool  in the Documents Toolbox.
2. Click the problem name to select it.
3. On the **Edit** menu, click **Copy**.
4. Click the location at which you want to insert the copy.
5. On the **Edit** menu, click **Paste**.

## Moving a Problem

You can move a problem within the same document or move it to a different document.

1. If necessary, click the Page Sorter tool  in the Documents Toolbox.
2. Click the problem name to select it.
3. On the **Edit** menu, click **Cut**.

4. Click the new location of the problem.
5. On the **Edit** menu, click **Paste**.

### **Deleting a Problem**

To delete a problem and its pages from the document:

1. If necessary, click the Page Sorter tool  in the Documents Toolbox.
2. Click the problem name to select it.
3. On the **Edit** menu, click **Delete**.

### **Printing Documents**

1. Click **File > Print**.

The Print dialog box opens.

2. Set options for the print job.
  - **Printer** — Select from your list of available printers
  - **Print What:**
    - **Print All** — prints each page on a separate sheet
    - **Viewable Screen** — prints selected pages with additional layout options (see **Layout**, below)
  - **Print Range** — Click **All Pages**, or click **Page range** and set the starting and ending pages.
  - **Layout:**
    - **Orientation** (portrait or landscape)
    - The number of TI-Nspire™ pages (1, 2, 4, or 8) to be printed on each sheet (available in **Viewable Screen** option only). The default is 2 pages per sheet.
    - Whether to allow space below each printed TI-Nspire™ page for comments (available in **Viewable Screen** option only)
    - **Margins** (from .25 inches to 2 inches). The default margin is .5 inches on all edges.
  - **Documentation information to include:**
    - **Problem name**, including the option to group the pages physically by problem
    - **Page label** (such as 1.1 or 1.2) under each page
    - **Page header** (up to two lines)
    - **Document name** in the footer
3. Click **Print**, or click **Save As PDF**.

**Note:** To restore the Print defaults, click **Reset**.

## Using Print Preview

- Click the **Preview** check box to toggle the preview pane.
- Click the arrows at the bottom of the preview pane to page through the preview.

## Viewing Document Properties and Copyright Information

**Note:** Most of these instructions apply only to the Teacher Software.

### Checking Page Size

1. In the Teacher Software, go to the TI-Nspire™ **File** menu and select **Document Properties**.
2. Click the **Page Size** tab.
3. A checkmark indicates the document's current page size.

### Viewing Copyright Information

The Teacher Software and Student Software let you view copyright information that has been added to a document.

1. On the TI-Nspire™ **File** menu, select **View Copyright Information**.

The Copyright Information dialog box opens.

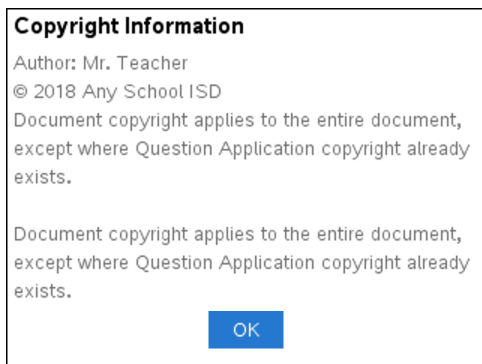

2. Click **OK** to close the dialog box.

### Adding Copyright Information to a Document

Using the Teacher Software, you can add copyright information to individual documents that you create, or you can apply the same copyright information to all new documents.

1. Open the document.



2. On the TI-Nspire™ **File** menu, select **Document Properties**.
3. Click the **Copyright** tab.
4. Edit the following fields to define the copyright details:
  - Author
  - Copyright (select Public Domain or Copyright).
  - Year (disabled if you selected Public Domain)
  - Owner (disabled if you selected Public Domain)
  - Comments
5. To add the supplied information to all new documents from this point forward, select **Apply this copyright to all new documents**.
6. Click **OK** to apply the copyright information to the document.

### **Protecting a Document (making a document read-only)**

Teachers can protect documents to create a document for distribution to your students or for other use. A student who receives a read-only document and makes changes to it will be prompted to save the document as a new file.

1. Open the document.
2. On the TI-Nspire™ **File** menu, select **Document Properties**.
3. Click the **Protection** tab.
4. Select the **Make this document Read Only** check box.
5. Click **OK**.

## Working with Lesson Bundles

Many lessons or activities contain multiple files. For example, teachers usually have a teacher version of a file, a student version, assessments, and sometimes supporting files. A lesson bundle is a container that enables teachers to group all files needed for a lesson together. Lesson bundles are used to:



- Add any type of file (.tns, .doc, .pdf, .ppt) to a lesson bundle.
- Send lesson bundles to connected handhelds or laptops; however, only the .tns files are sent to the handheld.
- View all the files in a lesson bundle using the TI-Nspire™ software.
- Group all files associated with one lesson in one place.
- Email one lesson bundle file to teachers or students instead of looking for and attaching multiple files.

### ***Creating a New Lesson Bundle***

Teachers and students can create new lesson bundles in the Documents Workspace. Teachers can also create new lesson bundles in the Content Workspace.

#### **Creating a Lesson Bundle in the Documents Workspace**

Complete the following steps to create a new lesson bundle. By default, the new lesson bundle does not contain files.

1. Click  in the Documents Toolbox to open the Content Explorer.
2. Navigate to the folder where you want to save the lesson bundle file.
3. Click  to open the menu, and then click **New Lesson Bundle**.

The new lesson bundle file is created with a default name and placed in your list of files.

4. Type a name for your lesson bundle.
5. Press **Enter** to save the file.

#### **Creating Lesson Bundles in the Content Workspace**

In the Content Workspace, teachers have two options for creating lesson bundles:

- When files needed for a lesson bundle are located in different folders, create an empty lesson bundle, and then add files to the lesson bundle.
- If all needed files are located in the same folder, create a lesson bundle with selected files.

## Creating an Empty Lesson Bundle

Complete the following steps to create a lesson bundle that does not contain files.

1. Navigate to the folder on your computer where you want to save the lesson bundle.

**Note:** If you are using the software for the first time, you may need to create a folder on your computer before creating a lesson bundle.

2. Click  or click **File > New Lesson Bundle**.

The new lesson bundle file is created with a default name and placed in the list of files.

3. Type a name for the lesson bundle and press **Enter**.

The lesson bundle is saved with the new name and details are shown in the Preview pane.

## Creating a Lesson Bundle Containing Files

You can select multiple files within a folder, and then create the lesson bundle. You cannot add a folder to a lesson bundle.

1. Navigate to the folder that contains the files you want to bundle.
2. Select the files. To select multiple files, select the first file then hold down **Shift** and click the last file in the list. To select random files, select the first file, and then hold down **Ctrl** and click the other files to select them.
3. Click , and then click **Lesson Bundles > Create New Lesson Bundle from selected**.

A new lesson bundle is created and placed in the open folder. The lesson bundle contains copies of the selected files.

4. Type a name for the lesson bundle and press **Enter**.

The lesson bundle is saved in the open folder and the details are shown in the Preview pane.

## Adding Files to a Lesson Bundle

Use any of the following methods to add files to a lesson bundle:

- Drag any file into a selected lesson bundle. This method moves the file to the lesson bundle. If you delete the lesson bundle, the file is deleted from your computer. You can recover the file from the Recycle Bin.

- Copy and paste any file into a selected lesson bundle.
- Use the "Add files to lesson bundle" option. This method copies the selected files into the lesson bundle. The file is not moved from its original location.

### Using the Add Files to Lesson Bundle Option

Use this option to add files to an empty lesson bundle or add more files to an existing lesson bundle.

1. Use one of the following options to select the lesson bundle file.
  - When working in the Documents Workspace, open the Content Explorer, and then double-click the lesson bundle file name.
  - When working in the Content Workspace, double-click the lesson bundle name.

**Note:** In the Content Workspace, you can also click the lesson bundle name to open the Files dialog box in the Preview pane. The Add Files to Lesson Bundle option is available from the Files dialog box. If the lesson bundle already contains files, the first file in bundle is shown in the Files dialog box.

The lesson bundle dialog box opens. The name reflects the name of the lesson bundle.

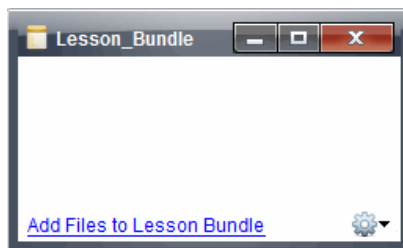

2. Click **Add Files to Lesson Bundle**.

The Add dialog box opens.

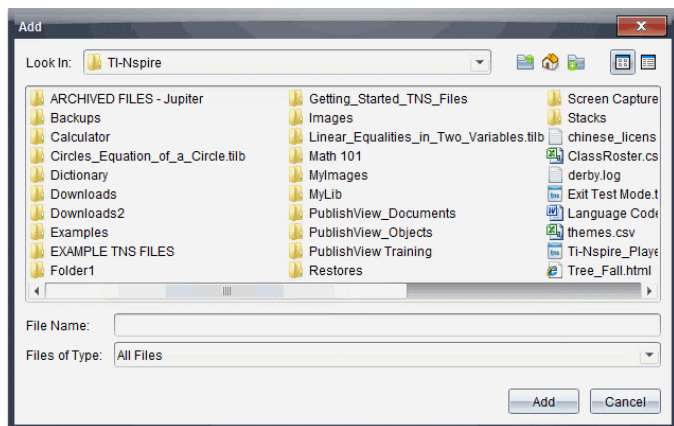

3. Navigate to and select the file you want to add to the lesson bundle.
  - You can select multiple files at one time if they are located in the same folder.
  - If files are located in different folders, you can add them one at a time.
  - You cannot create a folder within a lesson bundle or add a folder to a lesson bundle.
4. Click **Add** to add the file to the bundle.

The file is added to the bundle and is now listed in the lesson bundle dialog box.
5. Repeat this process until all needed files are added to the lesson bundle.

## ***Opening a Lesson Bundle***

To view and work with files within a lesson bundle, complete one of the following steps to open the lesson bundle file.

- ▶ Double-click the lesson bundle name.
- ▶ Select the lesson bundle, and then right-click and click **Open**.
- ▶ Select the lesson bundle, click , and then click **Open**.
- ▶ Select the lesson bundle, and then press Ctrl + O. (Mac®: ⌘ + O).

When you open a lesson bundle, the files in the bundle are displayed in a separate dialog box.

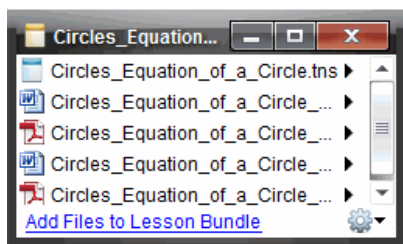

**Note:** You cannot open a lesson bundle outside of the TI-Nspire™ software. For example, if you open the folder using the file manager on your computer and double-click the lesson bundle name, it does not automatically launch the TI-Nspire™ software.

### Opening Files Within a Lesson Bundle

You can open any file within a lesson bundle on your computer if you have the program associated with the file type.

- When you open a .tns file, the file opens in the Documents Workspace in the TI-Nspire™ software.
- When you open another file type, it launches the application or program associated with that file. For example, if you open a .doc file, it opens in Microsoft® Word.

Use one of the following options to open a file within a lesson bundle:

- ▶ Double-click the lesson bundle, and then double-click a file within the lesson bundle.
- ▶ Within a lesson bundle, select the file, and then click ▶ or right-click the file name and select **Open**.

### Managing Files in a Lesson Bundle

You can open, copy/paste, delete, and rename files in an existing lesson bundle. To locate and work with files in an existing lesson bundle:

1. Choose one of the following options to locate an existing lesson bundle.
  - When working in the Documents Workspace, open the Content Explorer (click  in the Documents Toolbox), and then navigate to the folder where the lesson bundle is located.
  - When working in the Content Workspace, navigate to the folder where the lesson bundle is located in Content pane.

**Note:** When you click a lesson bundle name in the Content pane, the Files dialog box opens in the Preview pane. Select a file and right-click to open the context menu.

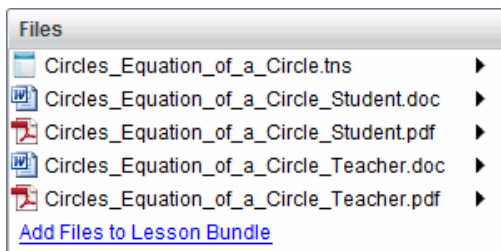

2. Double-click the lesson bundle name to open the Lesson Bundle dialog box.

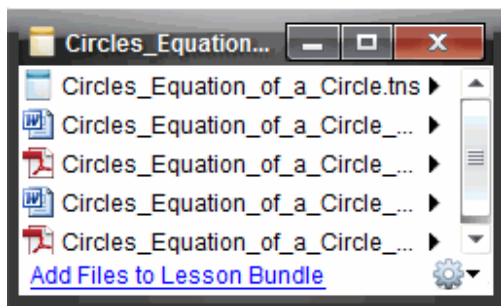

3. Select the file you want to work with and click ► to open the context menu.

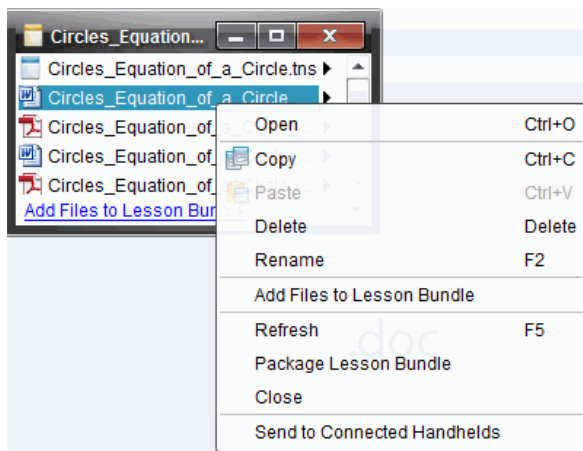

4. Click the action you want to perform:
  - Click **Open**. TI-Nspire™ documents open in the Documents Workspace. When you open another file type, it launches the application or program associated with that file.
  - Click **Copy** to place the file in the Clipboard.

- Navigate to a folder on your computer or select a connected handheld or laptop, and then right-click and click **Paste** to place the copied file in a new location.
- Click **Delete** to delete a file from the lesson bundle. Use caution when deleting a file from a lesson bundle. You should ensure files contained in the bundle are backed up if you need the files for future use.
- Click **Rename** to give the file a new name. To cancel this action, press **Esc**.
- Click **Add Files to Lesson Bundle** to select and add files to the bundle.
- Click **Refresh** to update the list of files in the bundle.
- Click **Package Lesson Bundle** to create a .tilb file
- Click **Send to Connected Handhelds** to open the Transfer Tool and send the selected file to connected handhelds. You can send .tns files and OS files.

5. When finished, click **Close** to close the dialog box.

## Managing Lesson Bundles

Use the options menu or the context menu to copy, delete, rename, or send a lesson bundle to connected handhelds or laptops. You cannot add a folder to a lesson bundle.

### Managing Lesson Bundles in the Documents Workspace

1. Open the Content Explorer, and then right-click the lesson bundle name or click  to open the context menu.

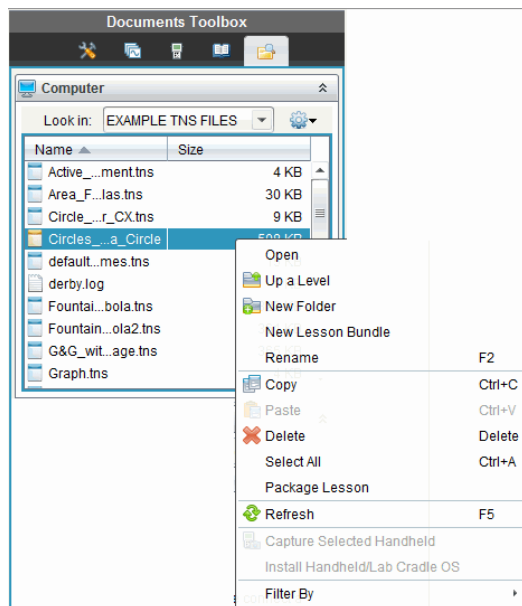



2. Click the action you want to perform. If an action is not available, it is dimmed.
  - Click **Open** to open the lesson bundle.
  - Click **Up One Level** to navigate up a level in the folder hierarchy.
  - You cannot add a folder to a lesson bundle. If you click **New Folder**, a new folder is added to the folder where the lesson bundle is stored.
  - Click **New Lesson Bundle** to create a new lesson bundle. The new lesson bundle is not added to the existing lesson bundle—it is created in the same folder as the existing lesson bundle.
  - Click **Rename** to change the name of the lesson bundle. Press **Esc** to cancel this action.
  - Click **Copy** to copy the lesson bundle to the Clipboard.
  - Navigate to another folder, and then click **Paste** to copy the lesson bundle in another location.
  - Click **Delete** to delete the lesson bundle. Use caution when deleting a lesson bundle. You should ensure files contained in the bundle are backed up if you need the files for future use.
  - **Select All** highlights all files in the open folder. This action does not apply to lesson bundles.
  - Click **Package Lesson** to create a .tilb file.
  - Click **Refresh** to update the list of files in the open folder.

### **Managing Lesson Bundles in the Content Workspace**

1. Click **Computer Content** in the Resources pane.
2. In the Content pane, navigate to the lesson bundle you want to work with, and then right-click to open the context menu or click  to open the menu of options.

Open	Ctrl+O
Copy	Ctrl+C
Paste	Ctrl+V
Delete	Delete
Refresh	Ctrl+R
Rename	F2
Up a Level	Alt+Up
New Folder	Ctrl+Shift+N
Create Shortcut...	
Lesson Bundles	▶
Send to Connected Handhelds	
Filter by	▶

3. Select the action you want to perform:

- Click **Open** to open the lesson bundle.
- Click **Copy** to place the lesson bundle file in the Clipboard.
- Navigate to a folder on your computer or select a connected handheld, and then right-click and click **Paste** to place the copied file in a new location.
- Click **Delete** to delete the lesson bundle. Use caution when deleting a lesson bundle. You should ensure files contained in the bundle are backed up if you need the files for future use.
- Click **Refresh** to update the list of files in the bundle.
- Click **Rename** to give the lesson bundle a new name. To cancel this action, press **Esc**.
- To move up a level in the folder hierarchy, click **Up a Level**.
- To add the lesson bundle to the list of shortcuts in Local Content, click **Create Shortcut**.
- To add more files to the lesson bundle, click **Lesson Bundles > Add Files to Lesson Bundle**.
- Click **Lesson Bundles > Package Lesson Bundle** to create a .tilb file.
- Click **Send to Connected Handhelds** to open the Transfer Tool and send the lesson bundle to connected handhelds.

## Packaging Lesson Bundles

Packaging lesson bundles creates a "package" folder with a .tilb file. This file contains all files contained in the lesson bundle. You must package the lesson before you can email the lesson bundle (.tilb file) to colleagues or students. By default, the lesson bundle is

saved in the following folder:  
...\\TI-Nspire\\New Lesson Bundle1.tilb\\package\\...

### Packaging a Lesson in the Documents Workspace

1. Open the Content Explorer.
2. Navigate to the folder where the lesson bundle is saved.
3. Select the lesson bundle you want to package.
4. Right-click to open the context menu, and then click **Package Lesson**.

The Lesson Bundle dialog box opens confirming that the .tilb file was created and the lesson bundle was successfully packaged.

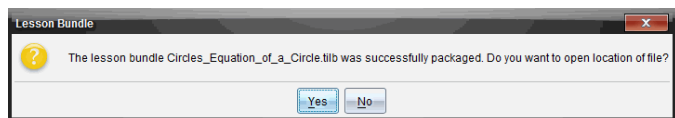

5. Click **Yes** to open the folder where the lesson package is stored. Click **No** to close the dialog box.

### Packaging a Lesson in the Contents Workspace

1. In **ComputerContent**, navigate to the folder that contains the lesson bundle you want to package.
2. Click the lesson bundle in the Content pane. The Lesson Bundle details are displayed in the Preview pane.
3. Use one of the following methods to create the package:
  - From the Preview pane, click ► in the Files dialog box, and then click **Package Lesson Bundle**.
  - From the Content pane, right-click the lesson bundle name, and then click **Lesson Bundles > Package Lesson Bundle**.

The Lesson Bundle dialog box opens confirming that the lesson bundle was created.

4. Click **Yes** to open the folder where the lesson package is stored. Click **No** to close the dialog box.

### Emailing a Lesson Bundle

After a lesson bundle is packaged, you can email the .tilb file to other teachers or students. To attach the lesson bundle to an email:

1. In your email client, select the option needed to attach a file, and then navigate to the .tilb folder.
2. Make sure you open the folder and select the .tilb file to attach to the email. You cannot email the .tilb folder.

### ***Sending Lesson Bundles to Connected Handhelds***

1. Complete one of the following actions to select a lesson bundle:
  - In the Documents Workspace, open the Content Explorer, and then select the lesson bundle you want to send.
  - In the Content Workspace, navigate to the lesson you want to send in the Content pane.
2. Drag the lesson bundle file to a connected handheld. You can also copy the lesson bundle, and then paste it to a connected handheld.

The lesson bundle is transferred to the handheld as a folder with the same name. Only .tns files are transferred to the handheld.

# Capturing Screens

Screen Capture enables you to:

- **Capture Class**
  - View and monitor all student screens at one time, which allows you to ensure all students are on track with an assignment.
  - Capture one or several student screens for discussion in the classroom. You can hide student names to focus the discussion on the lesson or concept, and not on individuals.
  - Select and display an individual student screen and view work as a live presentation.
  - Capture screen stacks that enable you to check student progress or collect student assignments for later review.
  - Save captured images as .jpg, .gif, or .png files, which can be inserted into TI-Nspire™ applications that allow images.
- **Capture Page**
  - Capture the active page in a TI-Nspire™ document from the software or from the TI-SmartView™ emulator as an image.
  - Save captured images as .jpg, .gif, .png, or .tif files, which can be inserted into TI-Nspire™ applications that allow images.
  - Copy and paste images into another application such as Microsoft® Word.
- **Capture Selected Handheld**
  - Capture the current screen on a connected handheld as an image.
  - Save captured images as .jpg, .gif, .png, or .tif files, which can be inserted into TI-Nspire™ applications that allow images.
  - Copy and paste images into another application such as Microsoft® Word.
- **Capture Images in Handheld Mode**
  - In the Documents Workspace, use the DragScreen feature to capture the emulator screen or side screen when the TI-SmartView™ Emulator is active.
  - Teachers can use this feature to drag and paste an image to presentation tools such as SMART® Notebook, Promethean's Flipchart, and Microsoft® Office applications including Word and PowerPoint®.

For web-based connectivity using your TI-Nspire™ CX II with a Chromebook, Windows® computer, or Mac® computer, go to [TI-Nspire™ CX II Connect](#).

## Accessing Screen Capture

The Screen Capture tool is available from all workspaces. To access Screen Capture:

- ▶ From the menu bar, click **Tools > Screen Capture**.
- ▶ From the toolbar, click .

## Using Capture Class

In the classroom, use the Screen Capture tool to view and capture student screens. You can capture the screen of one selected student, of multiple selected students, or of all the students in the class.



**Note:** To view and capture student screens, they must be logged into class.

### Capturing Student Screens

1. If you have not already done so, begin the class session and ask your students to log in.
2. From the **Tools** menu, select **Screen Capture > Capture Class**.  
–or–  
From the toolbar, click , and then click **Capture Class**.

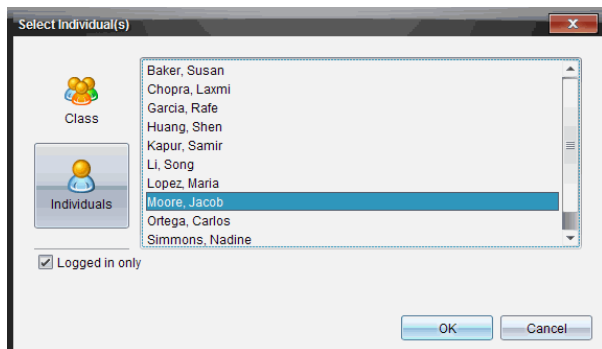
The Select Individual(s) dialog box opens. If you selected specific students in Class Workspace, only those names are highlighted. If no students were selected, all student names in the class are selected.



3. To change the selected student or add more students:
  - Click  to display the screens of all students in the class. If a student is not logged in, the handheld display indicates "Not Logged In." As students log in, click refresh to update your screen.
  - Click , and then click the name of each student to display the screens of individual students. To select multiple students, hold down the **Shift** key. To select students in random order, hold down the **Ctrl** key (Mac<sup>®</sup>: **⌘**) and click each student name.
  - Select the **Logged in only** check box under the left pane to display screens from only those students currently logged in. When you refresh your screen, any students who log in after the initial screen capture will be listed at the end of the Class Screen Capture window.
4. Click **OK**.

The screens of the selected students are displayed in the Class Screen Capture window.

**Note:** The following example shows the screens from two selected students who are logged in. The default view is Tiled, which shows all screens captured in the window.

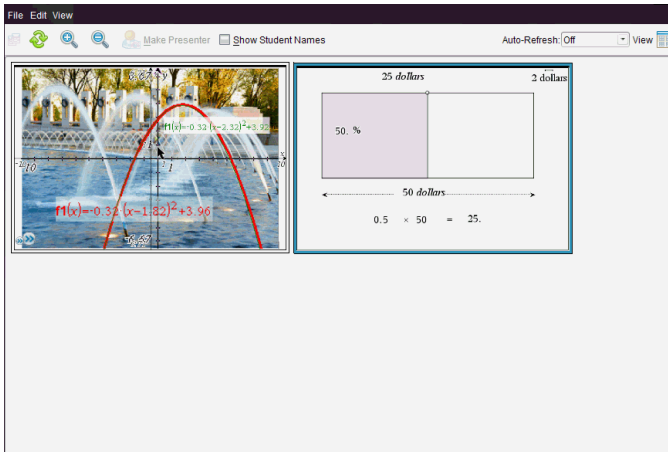

5. Decide if you want to display or hide the student names. To hide or show student names, select the check box on the toolbar to toggle between hide and show or click **View > Show Student Names**.

**Note:** Your selection to show or hide student names remains in effect until you change it. For example, if you select to hide student names, the student names will remain hidden when you close the Class Screen Capture window and return to the Class Workspace. If you select to hide student names in the Class Workspace, they will be hidden when the Class Screen Capture window opens.

### ***Setting Teacher Preferences for Capture Class***

Use the Teacher Preferences option to set preferences for using the randomize screen option and for displaying the teacher handheld. Creating a user name and password enables teachers to log in to an active class.

1. From the Class Workspace, click **File > Settings > Teacher Preferences**.

The Teacher Preferences dialog box opens.

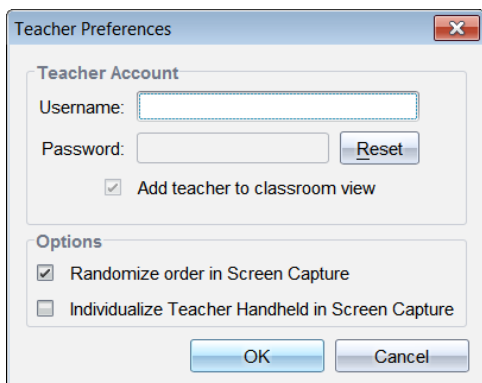

2. If you haven't already done so, create a Username and Password.
3. Select "Add teacher to classroom view" to show your handheld in the Class Screen Capture window.
4. To randomize the order in which screens are captured, select "Randomize order in Screen Capture."
5. Select the "Individualize Teacher Handheld in Screen Capture" option so that a captured screen from the teacher handheld appears differently in the Class Screen Capture window than screens captured from student handhelds.
6. Click **OK** to save the settings.

### **Setting View Options in Capture Class**

You have several options for optimizing the view of captured class screens, including:

- Toggling between a tiled view and a gallery view.
- Comparing selected screens in a side-by-side view.
- Refreshing the view as needed or setting the auto-refresh feature to automatically refresh the view at timed intervals.
- Zooming in or out to increase or decrease the size of the captured screens in the window. You can also select the percentage at which the size of the screen will be increased or decreased.
- Showing or hiding student names.
- Accessing Live Presenter options. For more information, see *Using Live Presenter*.

### **Toggling Between Tiled and Gallery Views**

When you capture student screens, the default view for the Class Screen Capture window is Tiled. Switch to Gallery view to show an enlarged view of a selected screen. Thumbnail views of all the captured screens are shown in the left pane, enabling you to find and select screens.



To toggle between Tiled and Gallery views:

- ▶ Click **View** , and then click **Gallery** or **Tiled**.

—or—

- ▶ From the **View** menu, select **Gallery** or **Tiled**.

—or—

- ▶ For Gallery view, press **Ctrl + G**. (Mac®: **⌘ + G**). For Tiled view, press **Ctrl + T** (Mac®: **⌘ + T**).

In Gallery view, thumbnail images of captured screens are displayed in a column in the left pane of this view. An enlarged view of a selected screen is displayed in the right pane.

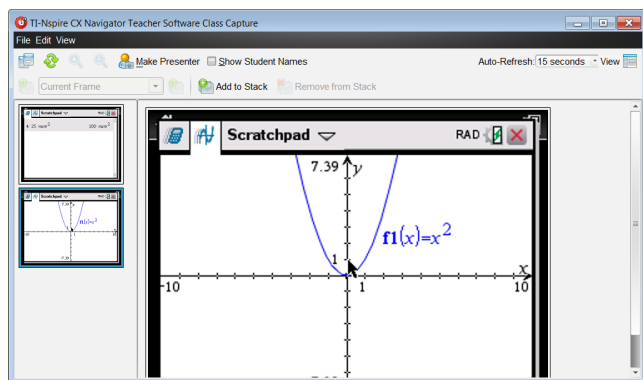

- If you select multiple thumbnails to view in the left pane, they are displayed in the right pane.
- If you select more than four thumbnails, view the additional screens by scrolling down the right pane.
- If you selected to show student names, names are centered under each student's captured screen.
- Zoom functions are disabled in Gallery View.
- You can change the order of the screens in the Gallery View.
- The width of the thumbnail pane cannot be changed.

## Rearranging Captured Screens

Changing the order of captured screens in one view (Tiled or Gallery) automatically changes it in the other view.

- ▶ In Tiled view, drag the screen to its new position.
- ▶ In Gallery view, drag the screen's thumbnail up or down to its new position.

As you drag, a vertical bar shows the point at which the screen will be inserted.

**Note:** To cancel the move before releasing the mouse button, press **Esc**.

## Refreshing Captured Screens

As students log in to class and work on their screens, you might want to update the captured screens.

### *Refreshing Screens Manually*

- ▶ Click **Refresh** .

**Note:** If a student has lost connection and a screen cannot be refreshed, it is outlined in yellow.

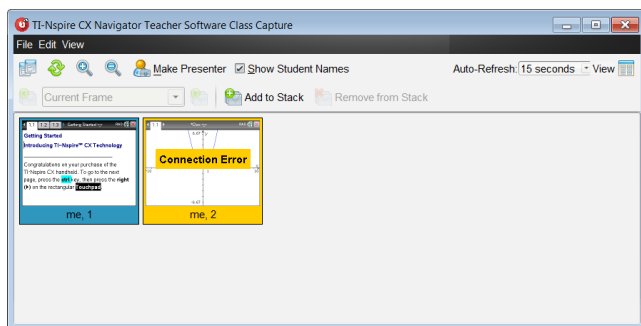

### *Refreshing Screens Automatically*

The auto-refresh feature recaptures class screens at timed intervals. The default setting for the auto-refresh feature is Off. To enable auto-refresh:

- ▶ On the **View** menu, click **Auto Refresh**, and select a time interval.

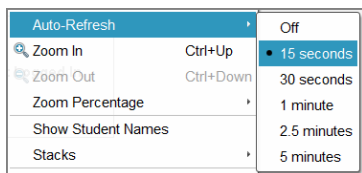

## Zooming in and Zooming out

In the Tiled view only, you can magnify or shrink the views of the captured screens.

- ▶ To zoom to levels between 50% and 400% in 50% increments:

Click Zoom In or Zoom Out on the toolbar.

–or–

Click **View > Zoom In** or **View > Zoom Out** from the menu.

- ▶ To zoom to a selected level, click **View > Zoom Percentage**, and select the level.

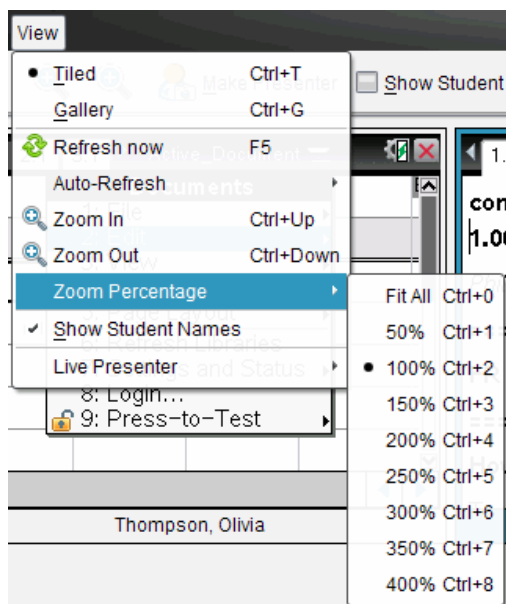

## Creating Stacks of Student Screens

This feature enables you to collect a history of one or more students' screens captured in the Capture Class option. These collections are called stacks, and you can add or remove screens from each student's stack, as well as navigate within and through student stacks. Using stacks is a convenient way to check progress in a lesson, collect

student presentations or assignments to review and grade later, or to show performance and progress in parent/teacher meetings.

You add, remove, navigate, and save stacks from the Class Capture window, which becomes available when you use the Capture Class option.

- ▶ To open the Class Capture window, click **Window > Class Capture Window**.

### Adding Screens to a Stack

- ▶ In the Class Capture window, click **View > Stacks > Add to Stack**, or click .
- ▶ To add another set of screens, first click **Refresh** and then add the stack.

When the first set of screens is added to a new stack, it is labeled Frame1. Each subsequent addition increases the number by one; for example, Frame2, Frame3, and so forth.



### Removing Frames from a Stack

1. Select the frame you want to remove.
2. Click **View > Stacks > Remove from Stack**, or click .

As frames are removed from a stack, their names are adjusted to remain sequential and reflect the deletion. For example, if Frame6 is deleted, Frame7 is renamed to Frame6 and all subsequent frame numbers are adjusted downward by one digit.

### Navigating Through Stacks

You can navigate a stack of frames from either the tiled or gallery view.

- ▶ To view different frames in a stack, use one of these options:
  - Click the drop-down arrow, and then click the desired frame from the list.
  - **View > Stacks > Next Frame**, or click .
  - **View > Stacks > Previous Frame**, or click .

**Note:** These options are available only if there is a next or previous frame to view.

### Saving Stacks

When you close the Class Capture window, the software asks if you want to save the stacks.

1. Click **Yes** to save the stacks.

The Select or Create Folder to Save Stacks dialog box opens.

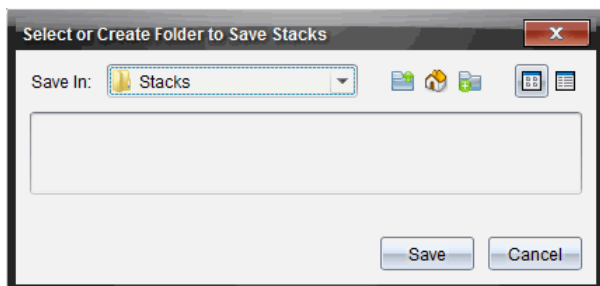

2. Click **Save** to save the stacks in the default folder, or create or navigate to another folder and then click **Save**.

The stacks are saved as individual screen captures with the student's name, image number, date, and time. For example:

Laxmi Chopra\_image1\_10-21-2011\_11-50

Laxmi Chopra\_image2\_10-21-2011\_11-57

Use the Content Workspace or your computer's file management system to locate and open the saved screens.

The screens open in the default photo viewer on your computer.

### ***Comparing Selected Screens***

This feature enables you to compare student screens side-by-side.

1. Select the student screens you want to compare. To select multiple consecutive screens, hold down the **Shift** key. To select screens in random order, hold down the **Ctrl** key (Mac®: **⌘**) and click each image you want to save. When you select each screen, the border changes color.

**Note:** If you select more than four screens, scroll down the viewing pane to see them.

2. Click **Edit > Compare Selected**.

If you are in Tiled view, the view switches to Gallery view and the selected screens are listed in the order selected.

**Note:** This option is disabled when in Gallery view.

3. To exit comparison mode, click outside the screen in the left pane of the Gallery view.

## Using Make Presenter

Select a captured screen from the Class Screen Capture window, and then click the **Make Presenter** option on the toolbar to launch Live Presenter and present a student screen to the class. You can only choose one student at a time to be the Live Presenter. For more information, see *Using Live Presenter*.

## Saving Screens When Using Capture Class

You can save captured screens for use in other TI-Nspire™ documents that allow images or for use in another application such as Microsoft® Word. You can save images in the following formats: .jpg, .png, or .gif. You can save one image at a time, select multiple images to save, or save all captured images.

### Saving Screen Images

To save screen images captured when using Capture Class, complete the following steps.

1. In the Class Screen Capture window, select the screen or screens you want to save as image files.
  - To select multiple consecutive screens, click the first image, and then hold down the **Shift** key and click the additional images. To select screens in random order, hold down the **Ctrl** key (Mac®: **⌘**) and click each image you want to save.
  - To select all captured screens, click **Edit > Select All**.
2. Click **File > Save Selected Screen(s)** or press **Ctrl + S** (Mac®: **⌘ + S**).

The Save dialog box opens.

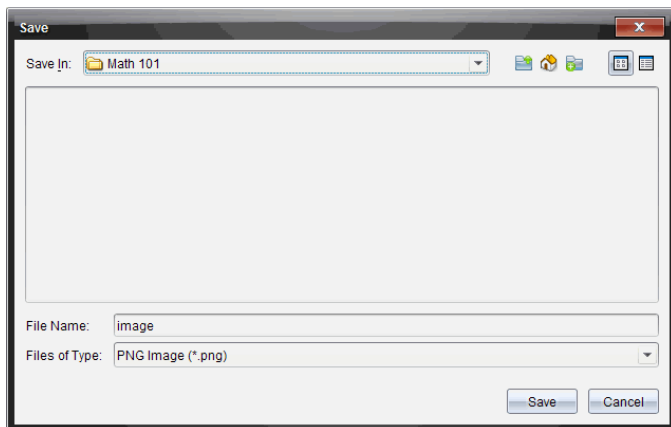

3. Navigate to the folder on your computer where you want to save the file(s).
4. Type a name for the file or files in the **File Name** field.

The default file name is *Image*.

- In the **Files of Type** field, click ▼, and then select the file type: .png, .jpg, or .gif. The default file type is .jpg.
- Click **Save**.

The file or files are saved in the designated folder.

- If you saved one image, the file is saved with the name as specified in the **File Name** field.
- If you saved multiple images, the files are saved with the name specified in the **File Name** field with a number appended to the file name to make each file name unique. For example, *Image1*, *Image 2*, and so on.

## Printing Captured Screens

You can print screens captured using the Capture Class option. You can print one, multiple, or all captured screens. For each printed page, the class name is printed in the page header, and the date and page number are printed in the page footer.

**Note:** The print option is not available when using the Capture Page or Capture Selected Handheld options.

To print a captured screen:

- Select the screen you want to print.
- Click **File > Print**.

The Print dialog box opens.

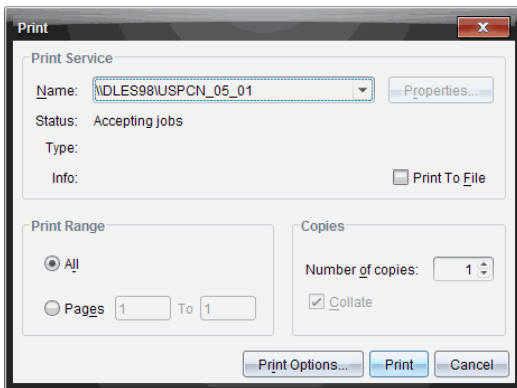

- If you selected more than one screen, click **Print Options** to select the number of screen captures that you want per page.

The Print Options dialog box opens.

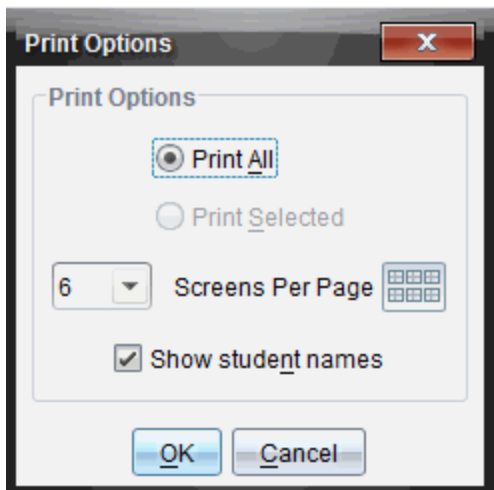

4. Select options as needed. You can select to print one screen per page, six screens per page, or all screens on the page. You can also select whether to print student names.
5. Click **OK** to return to the Print dialog box.
6. Select the individual printer options for your printer.
7. Select the number of copies you want to print.
8. Click **Print** to send the print job to the selected printer.

## Using Capture Page

Use the Capture Page option to capture an image of an active page in a TI-Nspire™ document. You can save images in the following file formats: .jpg, .gif, .png, and .tif. Saved images can be inserted into TI-Nspire™ applications that allow images. The image is also copied to the Clipboard and can be pasted into other applications such as Microsoft® Word or PowerPoint®.

### Capturing a Page

Complete the following steps to capture an image of an active page.

1. In the Documents Workspace, open a document and navigate to the page you want to capture to make it active.
2. Click , and then click **Capture Page**.

The image of the active page is copied to the Clipboard and to the Screen Capture

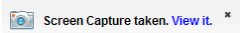
window. The  dialog box opens in the lower right corner of your desktop when the screen capture is complete.

3. Click **View it**.



The Screen Capture window opens.

You can also click **Window > Screen Capture Window** to open the Screen Capture window.

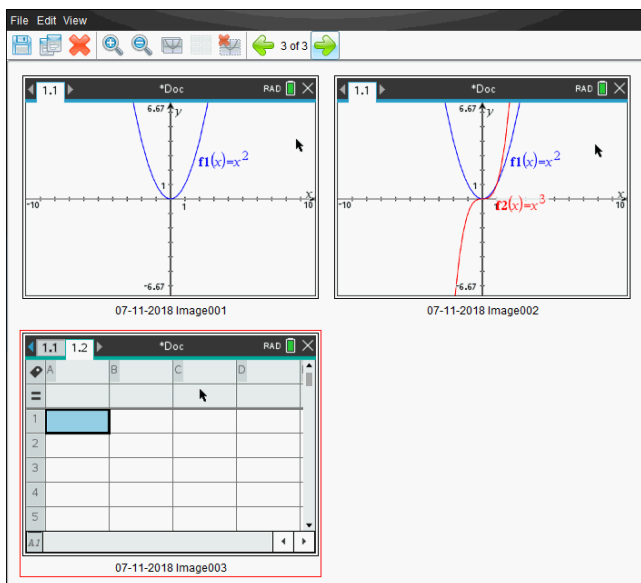

4. To capture additional pages, move to another page in the current document or open a new document to select a page.

As you capture additional pages, the images are copied to the Screen Capture window, which holds multiple images. The last page captured replaces the contents of the Clipboard.

## Using Capture Selected Handheld

Use the Capture Selected Handheld option to capture the active screen on a connected handheld.

1. On a connected handheld, navigate to the menu or to a page in a document you want to capture.
2. In the software, select the connected handheld:
  - In the Content Workspace, select the handheld from the list of Connected Handhelds in the Resources pane.
  - In the Documents Workspace, open Content Explorer from the Documents Toolbox, and then select the handheld from the list of Connected Handhelds.
  - In the Class Workspace, select a logged in student.
3. Click , and then click **Capture Selected Handheld**.

—or—

Click , and then click **Capture Selected Handheld**.

The screen is copied to the Clipboard and to the TI-Nspire™ Screen Capture

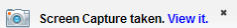
window. The  dialog box opens in the lower right corner of your desktop when the screen capture is complete.

#### 4. Click **View it**.

The Screen Capture window opens.

You can capture additional screens from an open document on a connected handheld or open another document on a connected handheld to capture screens from that document.

As you capture additional screens, the images are copied to the Screen Capture window, which holds multiple images. The last screen captured replaces the contents of the Clipboard.

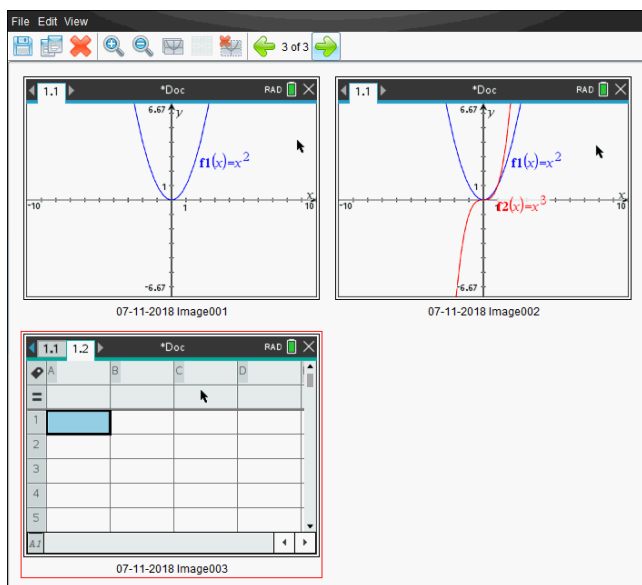

## Viewing Captured Screens

When you capture a page or screen, it is copied to the Screen Capture window.



## Zooming the View of Captured Screens

In the Screen Capture window, use the zoom in and zoom out options to increase or decrease the size of the captured screens.

- ▶ From the toolbar, click  to increase the size of the screens in the view. You can also click **View > Zoom In** from the menu.
- ▶ From the toolbar, click  to decrease the size of the screens in the view. You can also click **View > Zoom Out** from the menu.

## Saving Captured Pages and Screens

You can save captured pages and screens captured as images for use in other TI-Nspire™ documents that allow images or for use in other applications such as Microsoft® Word. You can save one image at a time, select multiple images to save, or save all captured images.

### Saving Selected Screens

1. In the Screen Capture window, select the screen image you want to save.
2. Click **File > Save Selected Screen(s)**.

**Note:** From the Screen Capture window, you can also click .

The Save as dialog box opens.

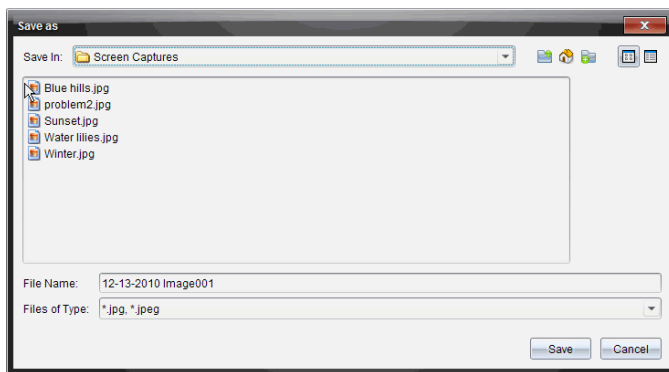

3. Navigate to the folder on your computer where you want to save the file.
4. Type a name for the file.  
**Note:** The default file name is *MM-DD-YYYY Image ###*.
5. Select the file type for the image file. The default format is .jpg. Click ▼ to select another format: .gif, .tif, or .png.
6. Click **Save**.

The file is saved in the designated folder.

## Saving Multiple Screens

1. In the Screen Capture window, select the screens you want to save.

To select multiple consecutive screens, click the first image, and then hold down the **Shift** key and click the additional images. To select screens in random order, press **Ctrl** (Mac®: **⌘**) and click each image you want to save.

2. Click  or select **File > Save Selected Screen(s)**. To save all captured screens, select **File > Save All Screens**.

**Note:** The "Save All Screens" option is not available when using Capture Class.

The Save as dialog box opens.

3. In the Save In field, navigate to the folder where you want to save the images.
4. In the File Name field, type a new folder name. The default folder name is *MM-DD-YYYY Image*, where *MM-DD-YYYY* is the current date.
5. Select the file type for the image files. The default format is .jpg. Click ▼ to select another format: .gif, .tif, or .png.
6. Click **Save**.

The images are saved in the specified folder with system-assigned names reflecting the current date and a sequence number. For example, *MM-DD-YYYY Image 001.jpg*, *MM-DD-YYYY Image 002.jpg* and so on.

## Copying and Pasting a Screen

You can select a captured screen and copy it to the Clipboard for inclusion into other documents or applications. You can also print copied screens. Copied screens are captured at 100% zoom level, and they are copied in the order of selection.

### Copying a Screen

1. Select the screen to copy.
2. Click  or **Edit > Copy**.

The selected screen is copied to the Clipboard.

### Pasting a Screen

Depending on the application you are pasting to, click **Edit > Paste**.

**Note:** You can also drag a screen capture to another application. This functions as a copy and paste.

## Working with Images

Images can be used in TI-Nspire™ applications for reference, assessment, and instructional purposes. You can add images to the following TI-Nspire™ applications:

- Graphs & Geometry
- Data & Statistics
- Notes
- Question, including Quick Poll

In the Graphs & Geometry and Data & Statistics applications, images are set in the background behind the axis and other objects. In the Notes and Question applications, the image is set at the cursor location inline with the text (in the foreground).

You can insert the following image file types: .jpg, .png, or .bmp.

**Note:** The transparency feature of a .png file type is not supported. Transparent backgrounds are displayed as white.

### *Working with Images in the Software*

When working in the TI-Nspire™ software, you can insert, copy, move, and delete images.

#### **Inserting Images**

In the Notes and Question applications, and in Quick Poll, you can insert more than one image on a page. You can only insert one image on a page in the Graphs & Geometry and Data & Statistics applications.

1. Open the document where you want to add an image.
2. Click **Insert > Image**.

The Insert Image dialog box opens.

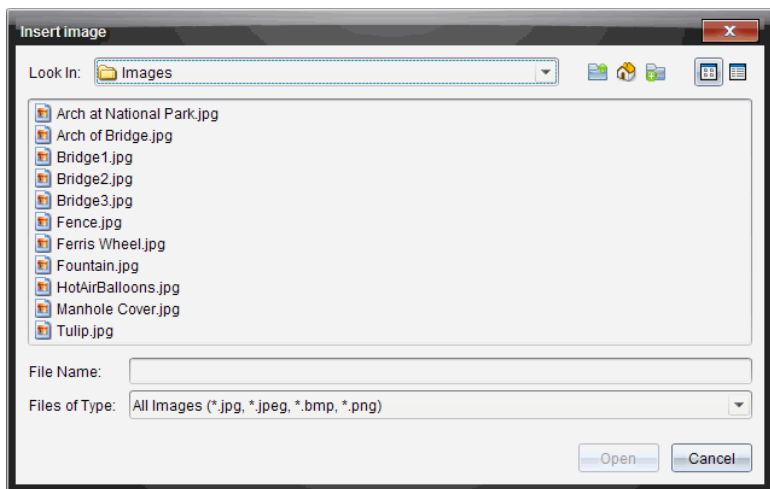



3. Navigate to the folder where the image is located and select the image.
4. Click **Open**.
  - In the Graphs & Geometry and Data & Statistics applications, the image is inserted in the background behind the axis.
  - In Notes, Question, and Quick Poll, the image is inserted at the cursor location. You can type text above or below the image, and you can move the image up or down on the page.

**Note:** You can also insert images by copying an image to the Clipboard and pasting it into the application.

### Moving Images

In applications such as Notes and Question where the image is set at the cursor location, you can reposition the image by moving the image to a new line or blank space, or by placing the image within a line of text. In the Graphs & Geometry and Data & Statistics applications, images can be moved to any position on the page.

1. Select the image.
  - In the Notes and Question applications, click the image to select it.
  - In the Graphs & Geometry and Data & Statistics applications, right-click the image, and then click **Select > Image**.
2. Click the selected image and hold the mouse button.

- If an image is in the foreground, the cursor changes to .
  - If an image is in the background, the cursor changes to .
3. Drag the image to the new location and release the mouse button to place the image.

If an image is in the foreground, the cursor changes to  when you hover your mouse pointer over a location where there is a new line or space. Images in the background can be moved and placed anywhere on the page.

### Resizing Images

To retain the aspect ratio of an image, resize by grabbing the image at one of the four corners.

1. Select the image.
  - In the Notes and Question applications, click the image to select it.
  - In the Graphs & Geometry and Data & Statistics applications, right-click the image, and then click **Select > Image**.
2. Move the cursor to one of the corners of the image.

The cursor changes to  (a four-sided directional arrow).

**Note:** If you drag the cursor to an edge of the image, the cursor changes to  (a two-sided directional arrow). If you drag an image from one of its edges to resize it, the image becomes distorted.

3. Click the corner or edge of the image.

The  tool is enabled.

4. Drag in to make the image smaller or drag out to make the image larger.
5. Release the mouse when the image size is correct.

### Deleting Images

To delete an image from an open document, complete the following steps.

1. Select the image.
  - If an image is in the foreground, click the image to select it.
  - If an image is in the background, right-click the image, and then click **Select > Image**.

2. Press **Delete**.

The image is removed.



# Using the Class Workspace

Use this workspace to add and manage classes and students, and to exchange files with students.

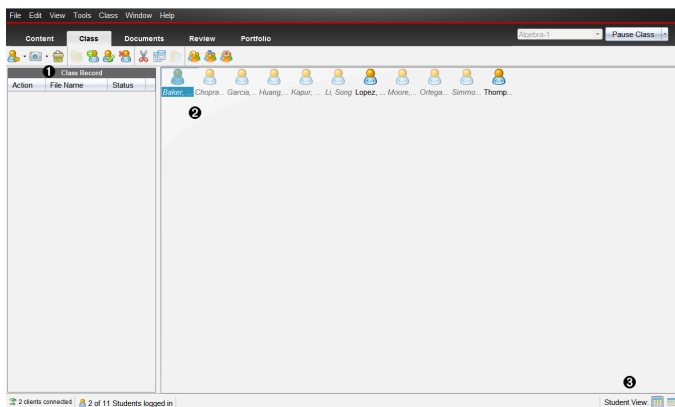

- 1 Class Record.** Document actions are shown here. You can open a document in the Review Workspace; save a document to the Portfolio Workspace; collect files from the Class Record Workspace; send and delete files using the toolbar, and view document properties in Record Item Properties.
- 2 Classroom area.** Shows the students in your class, which ones are logged in, and the status of file transfers for selected files in the Class Record. You can view the students by Seating Chart or by Student List.
- 3 Student View.** Lets you show the students in the classroom area in Seating Chart view or Student List view.

## Adding Classes

When you start using the TI-Nspire™ software, one of the first things you should do is create your classes. Make sure you create a class for each of the class periods you plan to teach.

If this is your first time using the TI-Nspire™ software, the classroom area may be empty. You can complete the following steps at any time.

The Add Classes Wizard guides you through the process of setting up classes. The software prompts you to add a class, and to add students to the class. You can choose to add classes manually or using a CSV file.

### Adding Classes Manually

1. Use the Workspace selector to select the Class Workspace.

2. Click **Class > Add Classes** or click  .

The Add Classes dialog box opens.

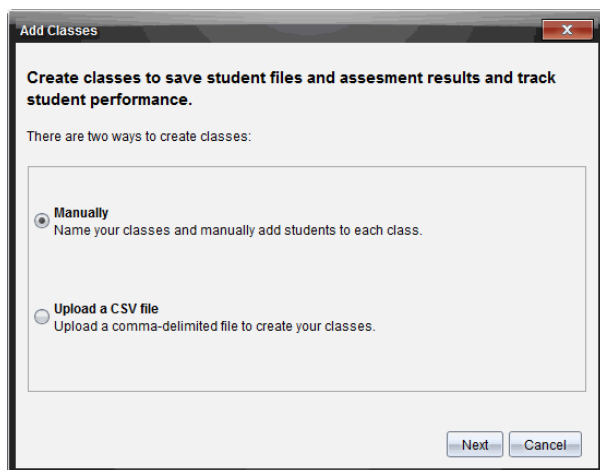

3. Select **Manually** from the Add Classes dialog box.
4. Click **Next**.

The Add Classes Manually dialog box opens.

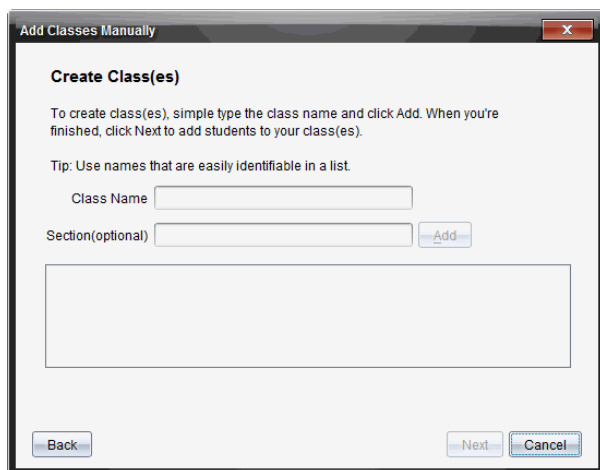

5. Type a Class Name. If needed, you can also provide a Section.

A class name must be between 3 and 32 alphanumeric characters. The class name cannot contain the special characters / \ : " | \* ? < > , and cannot contain these words:

lpt1, lpt2, lpt3, lpt4, lpt5, lpt6, lpt7, lpt8, lpt9, com1, com2, com3, com4, com5, com6, com7, com8, com9, aux, con, prn, nul.

6. Click **Add**.

The Add Classes Manually dialog box shows the class listed.

7. Continue adding classes, and click **Next** when you are done.

A dialog box displays showing successful class creation and asking if you want to add students.

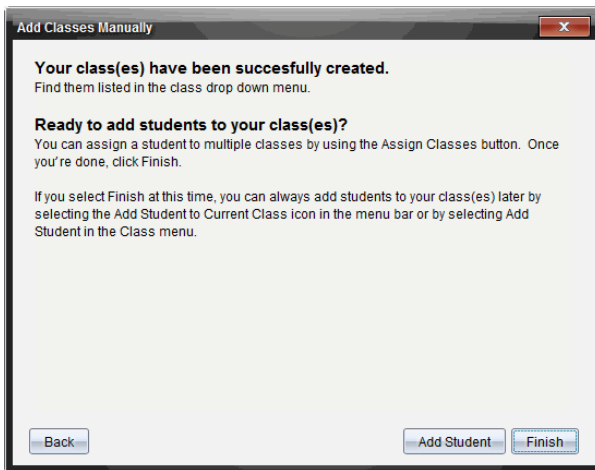

8. Click **Add Student**.

**Note:** Click **Finish** to Add Students later.

### Adding Classes with a CSV Upload

You can add classes with a CSV upload, and import a list of students into the class. Use the CSV upload option to import student information from a comma-separated values (CSV) file or a text (.txt) file.

The CSV or .txt file should have this information:

Class Name  
Section Name (optional)  
Student First Name  
Student Last Name  
Student User Name  
Student ID (optional)  
Password (optional)

1. Use the Workspace selector to select the Class Workspace.
2. Click **Class > Add Classes** or click .

The Add Classes dialog box opens.

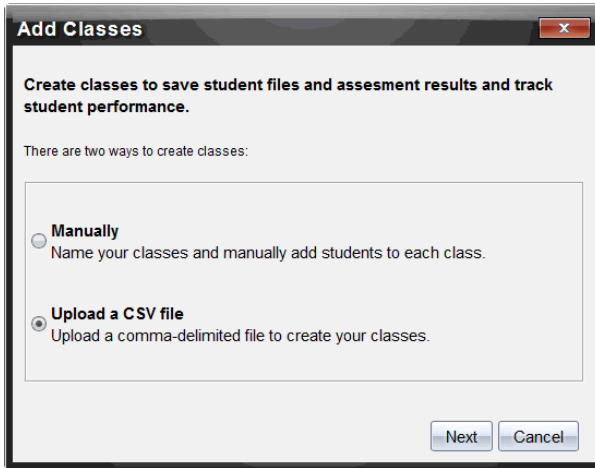

3. Select **Upload a CSV file** from the Add Classes dialog box.
4. Click **Next**.

The Add Classes by Uploading a CSV File dialog box opens.

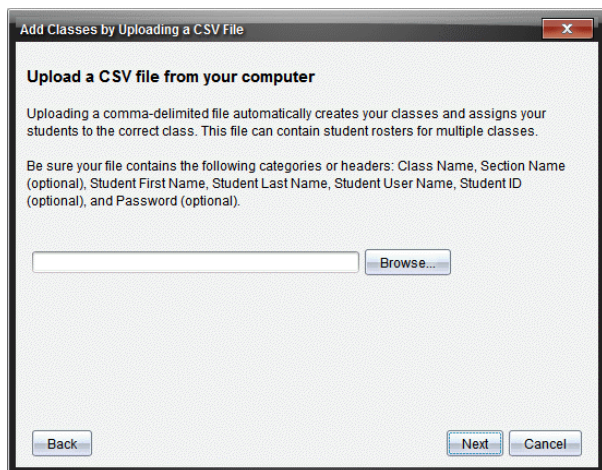

5. Click **Browse** to navigate to the file on your computer.
6. Select the file that contains the students you want to import.
7. Click **Open**.

The Add Classes by Uploading a CSV File dialog box shows the file.

8. Click **Next**.

The Mapping fields dialog box opens.

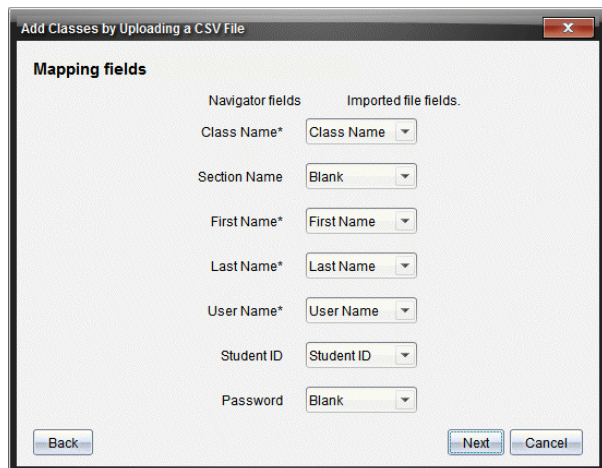

- Click ▼ and select a field from the drop-down lists to map the headings in your comma-delimited file.
- Click **Next**.

A dialog box opens showing completion status.

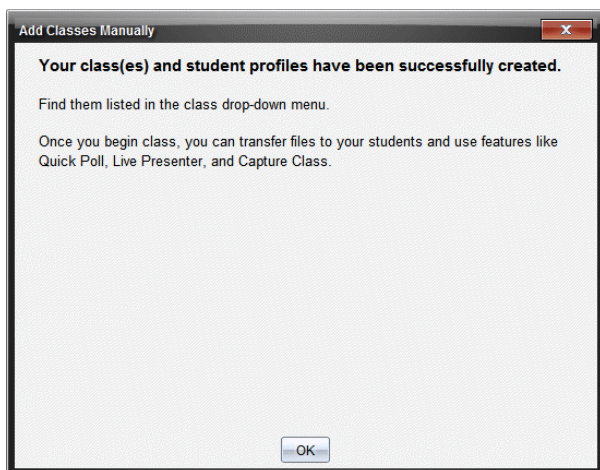

- Click **OK** to close

**Note:** If some students did not import successfully, click **View Details** to determine the problem.

## ***Adding Students to Classes***

After you create classes, you need to add students to the classes. You can add students to an active class session, or you can add students to any class at any time.

**Note:** These instructions explain how to add students after you create a class.

- Select the class to which you want to add students.
  - If class is in session, the student will be added to the current class. You have the option of adding the student to other classes.
  - If class is not in session, use the Class Session controls to select the class to which you want to add the student.

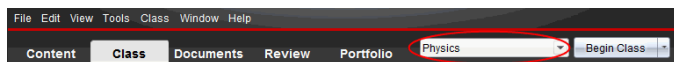

- Click **Class > Add Student** or click .

The Add Student dialog box opens.

The screenshot shows a dialog box titled "Add Student". It contains the following fields and controls:

- First Name: [Text Input Field]
- Last Name: [Text Input Field]
- User Name: [Text Input Field]
- Password:  Student Chooses  [Text Input Field]
- Display Name: [Text Input Field]
- Student ID: [Text Input Field]
- Classes: Algebra I [Assign Classes Button]
- [Add Next Student Button] [Finish Button] [Cancel Button]

3. Type the student's first name and last name.
4. Type a user name.

**Note:** The user name you choose must be unique. It cannot exist in the current class or any other class.

5. If you want your student to create their own password, select **Student Chooses**.  
—or—

If you want to create a password for your student, select the blank password entry box and type a new password.

6. (Optional) Type a display name.

**Note:** If you leave the display name blank, the software uses the student's first name as the display name.

7. (Optional) Type a student ID.
8. (Optional) Assign the student to other classes:
  - Click **Assign Classes**.

The Assign Classes dialog box opens.

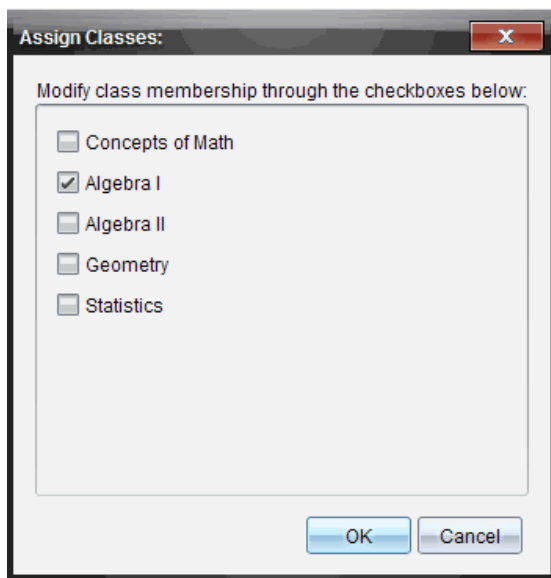

- Select the check boxes of the student's classes.
- Clear the check boxes of the classes to which the student does not belong.
- Click **OK**.

The Add Student dialog box opens.

9. If you need to add another student, click **Add Next Student** and repeat steps 3 – 8.
10. When all students are added, click **Finish**.

### ***Removing Students from Classes***

As necessary, you can remove students from your classes. When you remove students, the TI-Nspire™ software only removes them from the selected class. If the students are in other classes, they remain in those classes until you remove them.

#### **Notes:**

- You cannot remove students who are logged in to the TI-Nspire™ Navigator™ network.
- You cannot undo the removal of students.
- You can access many of the student account items by right-clicking the student icon in the classroom area and choosing an action from the menu.

To remove a student from a class:

1. Click the student you want to remove.
2. Click **Class > Remove Student**, or click .



The software asks if you are sure you want to remove the student.

3. Click **Yes**.

The software removes the student.

## **Updating Class Rosters**

You can update a single roster or multiple class rosters with new student information by importing a CSV file with updates.

**Note:** You cannot change existing student information or remove students already in the TI-Nspire™ Navigator™ database.

You can import a comma-separated value (CSV) file or a \*.txt file. The CSV or .txt file should have this information:

Class Name  
Section Name (optional)  
Student First Name  
Student Last Name  
Student User Name  
Student ID (optional)  
Password (optional)

1. Use the Workspace selector to select the Class Workspace.
2. Select the class for which you want to update the roster.

**Note:** Class cannot be started.

3. Click **Class > Update Class Roster**.

The Update Class Roster dialog box opens.

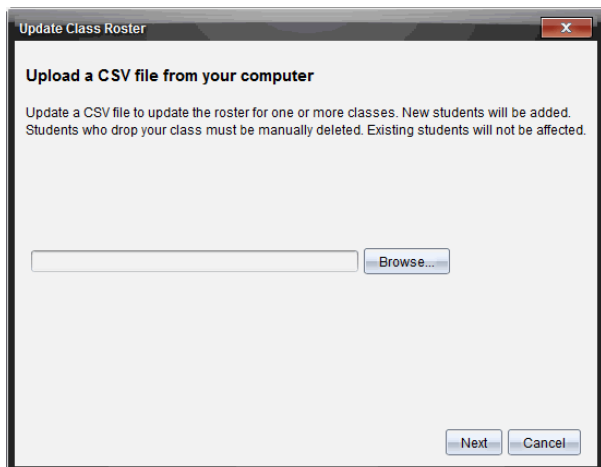

4. Click **Browse** to navigate to the file on your computer.

5. Select the file that contains the new students you want to import.
6. Click **Open**.

The Update Class Roster dialog box shows the file.

7. Click **Next**.

The Mapping fields dialog box opens.

The screenshot shows a dialog box titled "Update Class Roster" with a close button (X) in the top right corner. The main area is titled "Mapping fields" and is divided into two columns: "Navigator fields" and "Imported file fields." There are seven rows of fields, each with a label and a drop-down menu. The labels are "Class Name\*", "Section Name", "First Name\*", "Last Name\*", "User Name\*", "Student ID", and "Password". All drop-down menus are currently set to "Blank". At the bottom of the dialog, there are three buttons: "Back", "Next", and "Cancel".

8. Click ▼ and select a field from the drop-down lists to map the headings in your comma-delimited file.
9. Click **Next**.

A dialog box displays showing completion status.

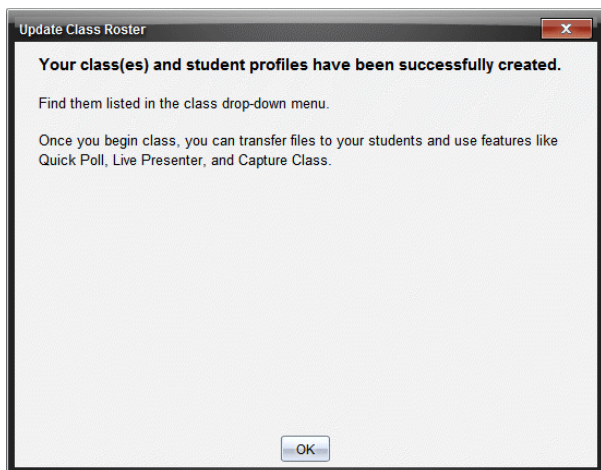

10. Click **OK** to close.

**Note:** If some students did not import successfully, click **View Details** to determine the problem.

## ***Managing Classes***

You can delete classes and remove all class information from the TI-Nspire™ Navigator™ database. You can also choose to hide or show classes in menus and views.

### **Deleting a Class**

When you delete a class, the software removes the class and removes the files on the hard drive that correspond to that class.

**Note:** You cannot undo the removal of a class.

1. If you have a class session running, end it.
2. Click **Class > Manage Classes**.

The Manage Classes dialog box opens.

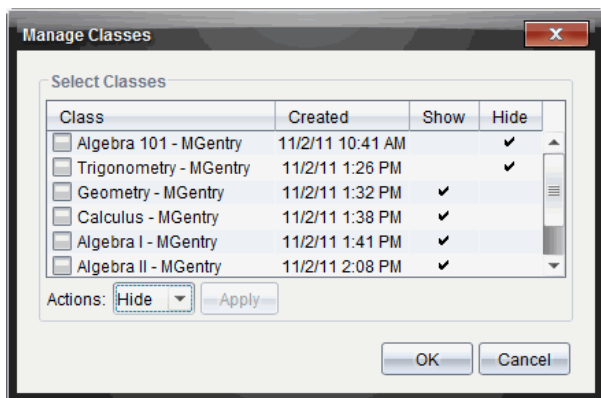

3. From the Class list, select the class you want to remove.
4. Select **Delete** from the Actions list.
5. Click **Apply**.

The software asks if you are sure you want to remove the class.

6. Click **OK**.

### Hiding a Class

When you hide a class, the class is removed from all workspace views and menus except for the Manage Classes dialog box.

**Note:** Hidden classes are not deleted from the TI-Nspire™ Navigator™ database.

1. Click **Class > Manage Classes**.

The Manage Classes dialog box opens.

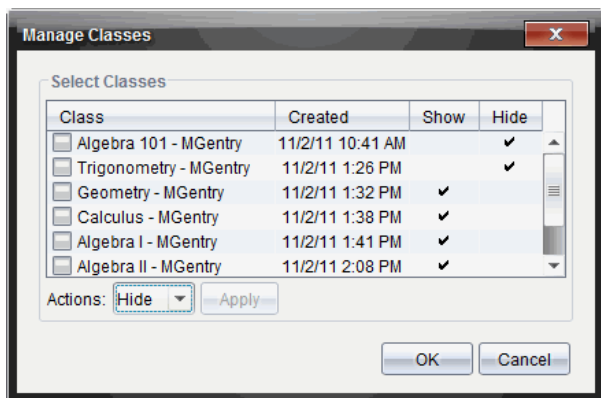

- From the Class list, select the class you want to hide.
- Select **Hide** from the Actions list.
- Click **Apply**.

The software asks if you are sure you want to hide the class.

- Click **OK**.

**Note:** Select **Show** from the Actions list when you want the class to show again.

## ***Beginning and Ending a Class Session***

A class session is the period of time the TI-Nspire™ software is active for a specific class. While a class session is running, you can perform communication functions with the selected class. You cannot use software to interact with your class until you begin a class session, and you cannot begin another class until you end the current one.

### **Beginning a Class Session**

- Click **Class > Select Class**, or click the Classroom Session list.

A list of available classes opens.

- Select the class you want to begin.
- Click **Begin Class**.

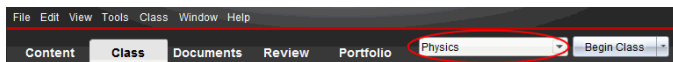

## Ending a Class Session

When class is over, or before you start another class, you need to end the current class session. Ending a class stops all communication between your computer and student handhelds or computers. When you end a class, students receive a message saying class is ended, and students are automatically logged off.

- ▶ To end a current class session, select **End Class** from the Class Actions drop down list.

## Pausing a Class Session

This function is available only on TI-Nspire™ software that supports handhelds. There are times you may want to pause a class. If using TI-Nspire™ software that supports handhelds, pausing a class suspends all activity on student handhelds, and they receive a message telling them class is paused. When you resume class, the message clears and students are able to use their handhelds. The students remain logged in when you pause a class.

1. To pause a class in session, click **Pause Class**.
2. To resume the class, click **Resume Class**.

## Changing the Student View

In the classroom area, you can view the students in the selected class in either the Student List view or the Seating Chart view. The Student List view shows students in a table that contains their display names, first name, last name, user name, and student ID. The Seating Chart view shows students as student icons with display names. You can change the class view at any time.

In either view, the warning sign next to a student icon indicates that the OS on the student's handheld does not match the software version on the teacher computer. Moving your mouse over the warning sign opens a tooltip indicating that an OS update is required.

## Changing the Class View to Student List

- ▶ Click **View > Student List** or click  in the status bar.

The view changes to Student List.

Picture	Display Name	First Name	Last Name	User Name	Student ID
	Olivia	Olivia	Thompson	101	1
	Maria	Maria	Lopez	102	2
	Samir	Samir	Kapur	103	3
	Jacob	Jacob	Moore	104	4
	Song	Song	Li	105	5
	Susan	Susan	Baker	106	6
	Shen	Shen	Huang	107	7
	Nadine	Nadine	Simmons	108	8
	Rafe	Rafe	Garcia	201	9
	Laxmi	Laxmi	Chopra	202	10
	Carlos	Carlos	Ortega	203	11

## Changing the Class View to Seating Chart

- ▶ Click **View > Seating Chart** or click in the status bar.

The view changes to Seating Chart view.

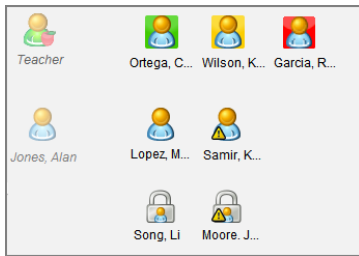

## Arranging the Seating Chart

Initially, students are arranged in the Seating Chart view in the order that you added them. However, you can rearrange the students so that they have the same seating arrangement in the Class Workspace as they do in your actual classroom. You can rearrange the seating chart at any time.

### Arranging Students in the Seating Chart

1. Select the class from the Class Session list.
2. Click **View > Seating Chart**.

The classroom area shows your class in the Seating Chart view.

3. Within the classroom area, drag each student icon to the location that you want.





The software moves the student icons to the new locations.

The software remembers the student positions the next time you start the same class.

**Note:** Do not place one student icon on top of another student icon. If you do this, you will only be able to see one of the student's icons.

## Checking Student Login Status

You can view the students' login status from the Seating Chart view. The color of the icon by the student display names indicates their login status as well as the class status:

Icon	Class status	Student status	Color
	Class session not started.	N/A	Grey
	Class session started.	Student not logged in.	Light blue
	Class session started.	Student logged in.	Dark blue
	Class session started.	Student OS does not match software version on teacher computer.	Dark blue

## Sorting Student Information

The Student List view in the classroom area shows the information for students in the selected class. It includes display names, first names, last names, user names, and student IDs. In the Student List view, you can sort student information by each of these categories. Information is sorted alphabetically from A-Z or Z-A and numerically from 1-9 or 9-1. You can sort student information at any time.

### Sorting Student Information

1. Click **Class > Select Class** and select the class that contains the student information you want to sort.

Note: If you have a class session running, you must end it to select the class.

2. In the menu, click **View > Student List**.
3. Click the column title of the list you want to sort.

The software sorts the selected list.

4. To sort the selected information in the opposite order, click the column title again.

## Changing the Classes Assigned to a Student

Occasionally your students may move to a different class, or they may take more than one of your classes. You can change student classes when necessary.

**Note:** You cannot change the classes of students who are logged in to the TI-Nspire™ Navigator™ network.

### Changing a Student's Class

1. Select a class to which the student belongs.
2. Click the student you want to edit.



3. Click **Class > Edit Student**, or click .

The Student Properties dialog box opens.

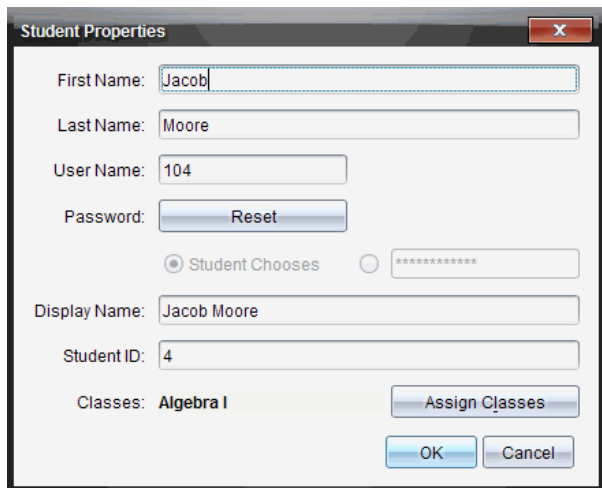

The Student Properties dialog box contains the following fields and controls:

- First Name:
- Last Name:
- User Name:
- Password:  with a **Reset** button.
- Radio buttons:  Student Chooses and  with a masked password field
- Display Name:
- Student ID:
- Classes: **Algebra I** (highlighted) with an **Assign Classes** button.
- OK** and **Cancel** buttons.

4. Click **Assign Classes**.

The Assign Classes dialog box opens.

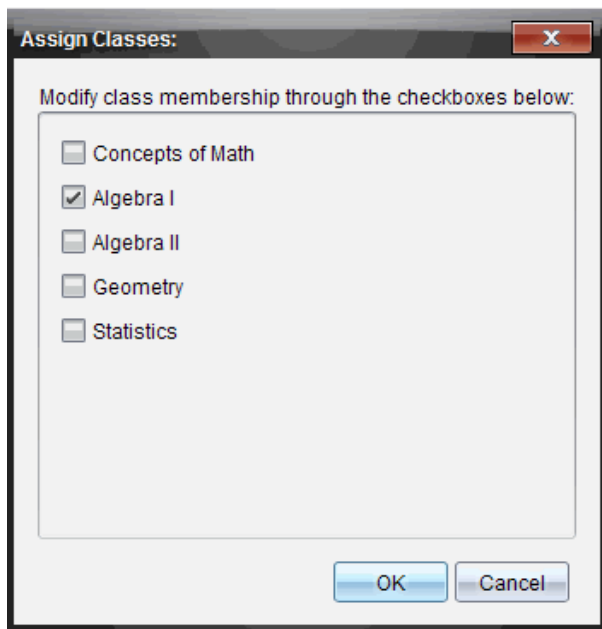

The Assign Classes dialog box contains the following elements:

- Title: **Assign Classes:**
- Instruction: **Modify class membership through the checkboxes below:**
- Checkboxes:
  - Concepts of Math
  - Algebra I
  - Algebra II
  - Geometry
  - Statistics
- OK** and **Cancel** buttons.

5. Select the check boxes of the student's classes.
6. Clear the check boxes of the classes to which the student does not belong.
7. Click **OK**.
8. In the Student Properties dialog box, click **OK**.

## ***Changing Student Names and Identifiers***

After you add students, you may find that you need to change one of their names or identifiers. There are five different names and identifiers associated with your students, including:

- First name
- Last name
- User name
- Display name
- Student ID

This section covers how to change any of these types of names and identifiers.

**Note:** You cannot change the account information of students who are logged in to the TI-Nspire™ Navigator™ network.

**Note:** You can access many of the student account items by right-clicking the student and choosing an action from the menu.

### **Changing Student Names or Identifiers**

1. Select a class to which the student belongs.

Note: If you have a class session running, you must end it to select the class.

2. Click the student you want to edit.
3. Click **Class > Edit Student**, or click .

The Student Properties dialog box opens.

4. Click the field of the name or identifier you want to change.
5. Make the necessary changes.
6. Repeat steps 4 and 5 for any other names or identifiers you want to change.
7. Click **OK**.

### ***Moving Students to Another Class***

If any of your students move to a different class, you can move them within the TI-Nspire™ software as well.

**Note:** You cannot move students who are logged in to the TI-Nspire™ Navigator™ network.

**Note:** You can access many of the student account items by right-clicking the student and choosing an action from the menu.

#### **Moving a Student to Another Class**

1. Select a class to which the student belongs.

**Note:** If you have a class session running, you must end it to move the student.

2. Click the student you want to move.
3. Click **Edit > Cut** or click .

The software removes the student from the class and moves the student account information to the Clipboard.

4. From the Class Session list, select the class where you want to move the student.
5. Click **Edit > Paste** or click .

The software moves the student to the selected class.

## ***Copying Students to Another Class***

When you have students in more than one of your classes, you may find it convenient to copy them from one class to another. Copying students saves you the time of entering all of their information again.

**Note:** You cannot copy students who are logged in to the TI-Nspire™ Navigator™ network.

**Note:** You can access many of the student account items by right-clicking the student and choosing an action from the menu.

### **Copying a Student to Another Class**

1. Select a class to which the student belongs.

**Note:** If you have a class session running, you must end it to select the class.

2. Click the student you want to copy.
3. Click **Edit > Copy** or click .

The software copies the student to the Clipboard.

4. From the Current Class dropdown list, select the class to which you want to copy the student.
5. Click **Edit > Paste** or click .

The software copies the student to the selected class.

## ***Exploring the Class Record***

From the Class Record, you can open a document in the Review Workspace; save a document to the Portfolio Workspace; collect files from the Class Record Workspace; send and delete files using the toolbar; and view document properties in Record Item Properties for all TI-Nspire™ documents, except Quick Poll files.

By default, 100 records are listed. To see additional records, click **Load Next 100** or click **Load All Entries**.

1	2	3	
Action	File Name	Status	
	Unprompted-05-18	(2)	▶
	BR 4.20	22 of 24	▶
	BR 4.20	23 of 24	▶
	Unprompted-05-16	(7)	▶
	BR 4.20.tns	23 of 24	▶
	BR 4.19	23 of 24	▶
	2011-12 A1 Geo...		▶
	BR 4.19	23 of 24	▶
	Unprompted-05-14	(10)	▶
	BR 4.19.tns	23 of 24	▶
	BR 4.18	22 of 24	▶
	2011-12 A1 Geo...		▶
	BR 4.18	22 of 24	▶
	Unprompted-05-10	(12)	▶
	BR 4.18.tns	23 of 24	▶
	BR 4.16	23 of 24	▶
	Golden_Ratio	23 of 24	▶
	2011-12 A1 Geo...		▶
	Golden_Ratio.tns	23 of 24	▶
	BR 4.16	23 of 24	▶
	Unprompted-05-08	(8)	▶
	BR 4.16.tns	23 of 24	▶
	Graph_Theory	0 of 24	▶
	BR 4.14	20 of 24	▶
	Hamilton_Around...	20 of 24	▶
	Hamilton_Around...	20 of 24	▶

**1** **File action.** The icons indicate the status of a file.

- Sent to class
- Collected from class
- Saved to portfolio
- Redistributed to class
- Quick Poll
- Unprompted
- Deleted

**2** **File name.** The names of files used in this class.

**3** **Status.** The progress of an action. For example, "23 of 25" indicates that 23 out of 25 students have received a file.

**4** **Menu options.** Click ▶ for quick access to certain menu items. This icon gives you the same options as a right-click.

## Sending Files to a Class

You can send files and folders to your whole class, members of the class currently logged in, or to individual students. Class must be in session for you to send the files.

When you send a file to the whole class, all students currently logged in will receive the file immediately. Students not logged in will receive the file when they log in.

### Notes:

- Only TI-Nspire™ (.tns) file types open in the TI-Nspire™ software.
- Other file types (if supported) such as images, word processing, or spreadsheet files, open in the application the operating system has associated with the file type.

### Sending Files

1. Click **Tools > Send to class** or click .

The Select file(s) to send dialog box opens.

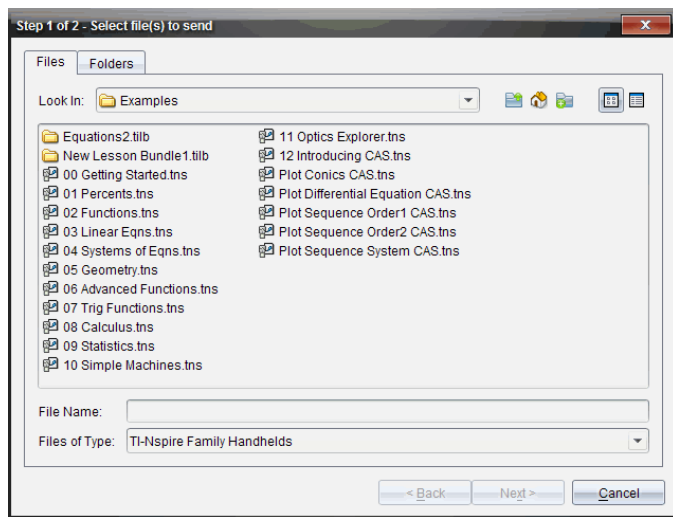

2. Click the **Files** tab to choose files, or click the **Folders** tab to choose folders.

**Note:** You can send only files or folders, not a combination of files and folders.

- TI-Nspire™ CX Premium Teacher Software for handhelds transfers only .tns files.
3. To choose the files or folders you want to send, do one of the following:

- Navigate to the file or folder you want to send and click it. To select multiple files or folders, press and hold the **Ctrl** key (Mac®: **⌘**) while clicking each file name.
- Type the name of the file or folder in the **File name** or **Folder name** box. Folder names may use alphanumeric characters, but cannot contain the special characters `/ \ : " | * ? < > ,` and cannot contain these words:  
lpt1, lpt2, lpt3, lpt4, lpt5, lpt6, lpt7, lpt8, lpt9, com1, com2, com3, com4, com5, com6, com7, com8, com9, aux, con, prn, nul.



**Note:** You can also drag files from a file browser window to the Class Record to send files.

4. Click **Next**.

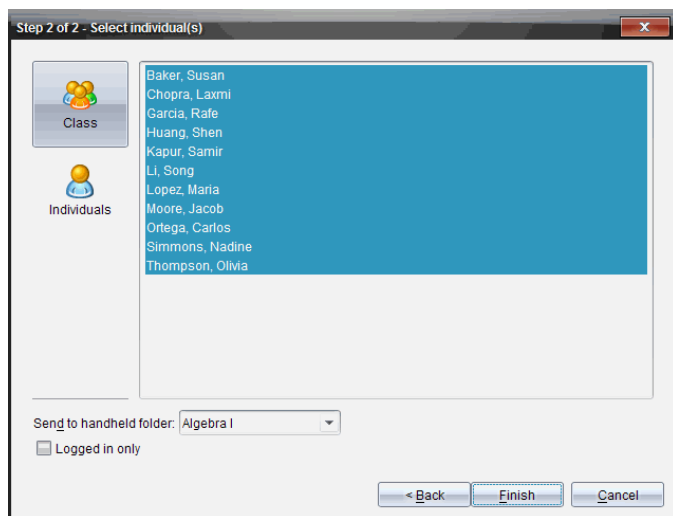
The Select individual(s) dialog box opens.



5. Select the student(s) to whom you want to send the file:

- To send the file to the whole class, click **Class** . To send the file only to class members who are currently logged in, select the **Logged in only** check box.
- To send the file to an individual student, click **Individuals** , and then click the student.

**Note:** If you had any students selected in the classroom area, the software already has them selected.

- Use the **Send to handheld folder** drop-down list to choose from the current class folder, the top level folder on the handheld, or the last 10 folders that files were sent to. (Available only in TI-Nspire™ software that supports handhelds.)
  - You can also enter a folder name path in the drop-down list.

6. Click **Finish**.

The file transfer appears in the Class Record.

### **Sending Missing Files**

The Send Missing function becomes active after you have completed the original transfer. This function resends files to only those students who were not logged in or targeted for the original transfer.

1. From the Class Record, select the send action of file that was sent to class.

**Note:** The send action cannot be active.

2. Click **File > Send Missing**.

### **Redistributing Selected Files to Class**

The Redistribute Selected to Class function allows you to review, modify, and send selected assignments back to your students.

1. From the Class Record, select the collect action of the modified original file or files.
2. Click **File > Redistribute Selected to Class**.

**Note:** It will only send files back to student's collected from.

### **Collecting Files from Students**

You can collect any previously sent files located in student class folders by using the Class Record. You can also collect new files from students by typing the full file name.

When you collect files from the menu or icon, you have the option of deleting the collected files from student class folders.

**Note:** If a student deleted a file, renamed a file, or stored it in another location, the file cannot be collected.

To collect files, class must be in session. If any students are not logged in, files you collect are automatically transferred when they log in.

### **Collecting Files from the Class Record**

1. From the Class Record, choose the file or files that have been sent to class.



Note: By default, the first 100 records are listed. To display additional records, click **Load Next 100** or click **Load All Entries**.

Class Record		
Action	File Name	Status
	AlgebraTest1	4 of 4 ▶
	AlgebraTest1.tns	4 of 4 ▶
	Concepts of Math - KP...	▶
	Homework3	0 of 1 ▶
	AlgebraTest2.tns	1 of 1 ▶
	Concepts of Math - KP...	▶
	Concepts of Math - KP...	▶
	Concepts of Math - KP...	▶
	Concepts of Math - KP...	▶
	Concepts of Math - KP...	▶
	Lists	1 of 1 ▶
	AlgebraTest2.tns	1 of 1 ▶
	Lists.tns	1 of 1 ▶
	AlgebraTest1	0 of 1 ▶
	AlgebraTest1	2 of 2 ▶
	AlgebraTest1	2 of 2 ▶
	AlgebraTest1	2 of 2 ▶
	AlgebraTest1.tns	2 of 2 ▶
	Concepts of Math - KP...	▶
	Concepts of Math - KP...	▶
	Concepts of Math - KP...	▶

2. Click ▶ next to any of the highlighted files and choose **Collect Selected from Class**.

The file transfer appears in the Class Record.

### Collecting Files from the Menu or Icon

1. Click **Tools > Collect from Class** or click



The Select file(s) to collect dialog box opens.

2. To choose the files or folders you want to collect, do one of the following:
  - Click **Recent Files** and navigate to the file you want to collect and click it. To select multiple files or folders, press and hold the **Ctrl** key (Mac®: **⌘**) while clicking each file name.
  - Click **Enter Filename** and type the name of the file in the **File name** box, and then click **Add**.

3. Click **Next**.

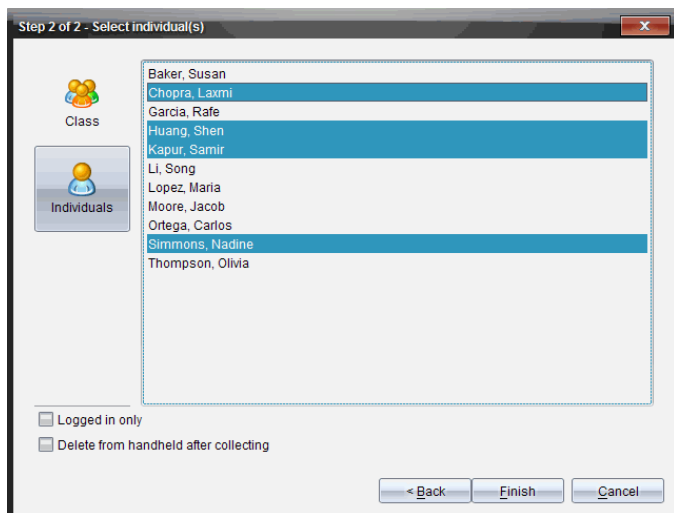
The Select individual(s) dialog box opens.



4. Select the student(s) from whom you want to collect the file:
  - To collect the file from the whole class, click **Class** . To collect the file only from class members who are currently logged in, select the **Logged in only** check box.
  - To collect the file from an individual student, click **Individuals** , and then click the student.

**Note:** If you had any students selected in the classroom area, the software already has them selected.

5. If you want to remove the file from student class folders after you collect it, select the check box next to the option to delete the file after it is collected.
6. Click **Finish**.

The collected file appears in the Class Record.

### Collecting Missing Files

The Collect Missing function becomes active for files that have not been received from students.

1. From the Class Record, select the collect action of file that was sent to class.
2. Click **File > Collect Missing**.

**Note:** The collection action cannot be active.

## Managing Unprompted Actions

When a student logged into a class session sends you a file outside of a collection, an Unprompted action is created.

These files, which are stored in a database, are shown in the Class Record until they are removed.

### Reviewing and Opening Unprompted Actions

Unprompted actions are named "Unprompted" followed by the month and date. Each class session contains all .tns files sent from students in one Unprompted folder.

The latest Unprompted action appears at the top of the Class Record for the most recent files sent by a student during a class session. During the next class session, more recent Unprompted actions appear in the Class Record above the previous action.

To open the Unprompted action:

1. Double-click the action or right-click and choose **Record Item Properties**.

The Unprompted dialog box opens. By default, no items in the Unprompted action are selected.

2. In the Unprompted dialog box, you can view one or more items, save the items to the Portfolio Workspace, remove the items, export the items to another file location, or do nothing.

### Viewing Items in an Unprompted Action

1. From the Unprompted dialog box, select the check box to the left of the item(s) you want to view.

**Note:** You can also click the **View** icon beside an item to quickly access the item.

2. Click **View**.

The items open as read-only files.

### Removing Individual Items from an Unprompted Action

Unprompted actions remain in the Class Record until you remove them. Even if you have exported or saved items, its Unprompted action continues to show until you remove it. To remove items from an Unprompted action:

1. In the Class Record, double-click the Unprompted action to open it.
2. From the Unprompted dialog box, select the check box to the left of the item(s) you want to remove.

3. Click **Remove**.

### **Exporting Unprompted Action Items**

You can export items from the database to the file system. To export items from an Unprompted action:

1. In the Class Record, double-click the Unprompted action to open it.
2. Select the files you want to export.
3. Click **Export**.

A file browser opens.

4. Select the location for the export.
5. Click **Select Folder**.

### ***Saving Files to a Portfolio Record***

You can save collected and unprompted files to a Portfolio record.

1. From the Class Record, select the files.
2. Click  and select **Save selected to Portfolio**.

The **Save to Portfolio** dialog box opens.

3. Select to save the files to a new Portfolio column or add them to an existing Portfolio column.
  - To add the files to a new Portfolio column, click **Add as new portfolio column** and type the name for the new Portfolio column.
  - To save the files to an existing Portfolio column, click **Add to existing portfolio column** and select the column name you want from the drop-down list.
4. Click **Save**.

**Note:** The files you saved in the Portfolio Workspace are shown in the Class Record until you remove them using the Remove command.

### ***Deleting Files from Class Folders***

When necessary, you can delete files from student class folders. You can delete files that were sent to the class or collected from the class. Class must be in session for you to delete files.

**Note:** Deleting a file only removes the specified file from the class folder. If the student saved a copy with another name, or copied the file to another location, the student still has access to the file.



1. Click **Tools > Delete from class** or click .

The Select file(s) to delete dialog box opens.

- To choose the files you want to delete, do one of the following:
  - Click **Recent Files** and navigate to the file you want to delete and click it. To select multiple files or folders, press and hold the **Ctrl** key (Mac®: **⌘**) while clicking each file name.
  - Click **Enter Filename** and type the name of the file in the **File name** box, and then click **Add**.
- Click **Next**.

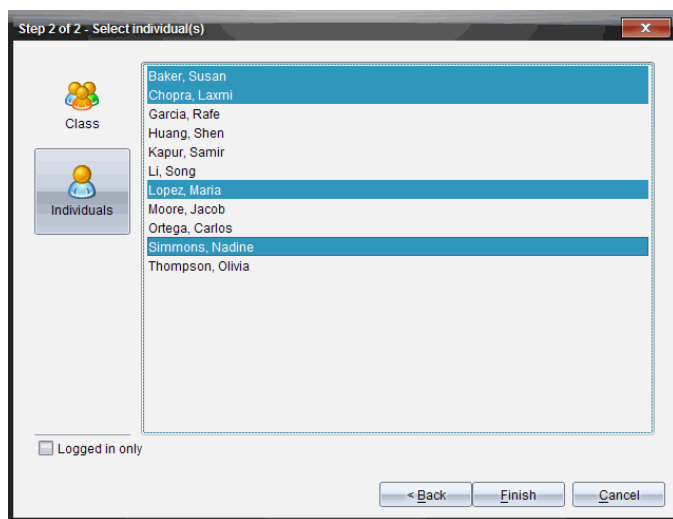
The Select individual(s) dialog box opens.



- Select the student(s) whose files you want to delete.
  - To delete the file from the whole class, click **Class** . To delete the file only from class members who are currently logged in, select the **Logged in only** check box.
  - To delete the file from an individual student, click **Individuals** , and then click the student name.

**Note:** If you had any students selected in the classroom area, the software already has them selected.
- Click **Finish**.



The file deletion appears in the Class Record.

### **Checking the Status of File Transfers**

When you send, collect, or delete files, you may want to check to see which of your students have received or sent their files.

- ▶ In the Class Record, click the file whose status you want to check.

In the classroom area, the software indicates the status of students as follows:

-  A green background indicates that students have sent/received/deleted the file.
-  A yellow background indicates that students received the collect or delete action, but they do not have the file in their class folder.
-  A red background indicates that students have not yet sent/received/deleted the file.

**Note:** You can also see the file transfer status in the file's Properties dialog box.

### ***Canceling File Transfers***

If you change your mind about a file transfer, you can cancel the transfer in the Class Record. Canceling file transfers stops the software from transferring more files. Any files that transfer before you cancel remain in student class folders.

1. In the Class Record, click the file whose transfer you want to cancel.
2. Click **Edit > Remove from Class Record**.

The software asks if you are sure you want to remove the action.

3. Click **Remove**.

The software stops the file transfer and removes the file from the Class Record list.

### ***Viewing File Properties***

Each file that you send or collect has a set of properties that you can view, except for Quick Poll files. File properties include name, size, date sent, and status. You can view the file properties at any time.

1. Select the file in the Class Record.
2. Right-click the file name and select **Record Item > Properties**.

The Statistics Properties dialog box opens showing the file properties.

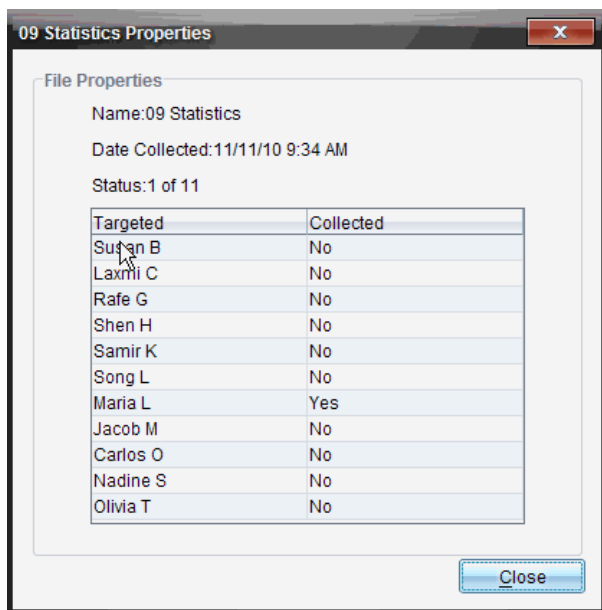

## ***Resetting Student Passwords***

Because the TI-Nspire™ software maintains the privacy of student passwords, you cannot retrieve passwords for your students if they forget them. However, you can reset student passwords. You can reset passwords for all of the students in a class or for individual students.

**Note:** You cannot reset the passwords of students who are currently logged in to the TI-Nspire™ Navigator™ network.

### **Resetting Passwords for all Students in a Class**

1. Select the class.

**Note:** Student(s) must be selected to perform a successful reset of the password.

2. Click **Class > Reset Student Password(s)**.

The Confirm Reset Student Passwords dialog box opens.

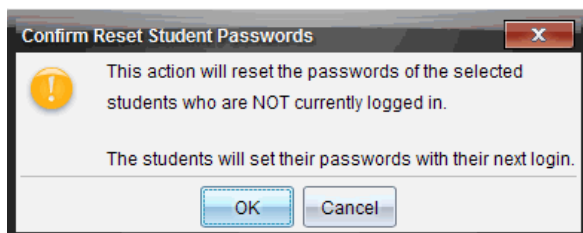

3. Click **OK**.
4. The next time students log in, instruct them to type a new password.

### Resetting Passwords for Individual Students

1. Click the student you want to edit.
2. Click **Class > Edit Student**, or click , or right-click the student name and choose **Edit Student** from the menu.

The Student Properties dialog box opens.

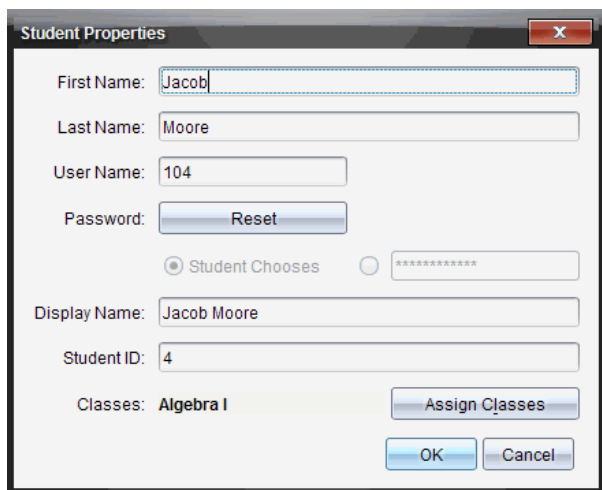

3. Click the **Reset** button next to **Password**.
4. If you want a student to create their own password, select **Student Chooses**.

—or—



If you want to create a specific password for the student, select the blank password entry box and type a new password.

5. Click **OK**.

The software resets the student's password.

6. The next time the student logs in:

- If you selected Student Chooses, instruct the student to type a password.
- If you created a password for the student, tell the student the new password.

## Using Live Presenter

In the TI-Nspire™ CX Premium Teacher Software, Live Presenter enables teachers to project and present actions on a selected handheld in real-time. Teachers can choose to project their own handheld screen or any student's handheld screen to show work as it is being performed and discuss the step-by-step process with the class. During the live presentation, you can show the TI-Nspire™ handheld being displayed and show the keys as they are pressed by the presenter.

Teachers can also control what appears on the presentation screen: student's name, handheld display, or keypress history. Teachers can also record the Live Presenter session and save the file as a movie for later use.

While Live Presenter is active, all other student handhelds are unaffected by the presentation and can be used.

**Note:** Live Presenter can be used with a handheld that is not logged into a class. This section assumes that the handheld is logged into a class, but any differences will be noted as needed.

### Hiding and Showing Student Names

If showing, the student name is shown under the handheld screen in Live Presenter.

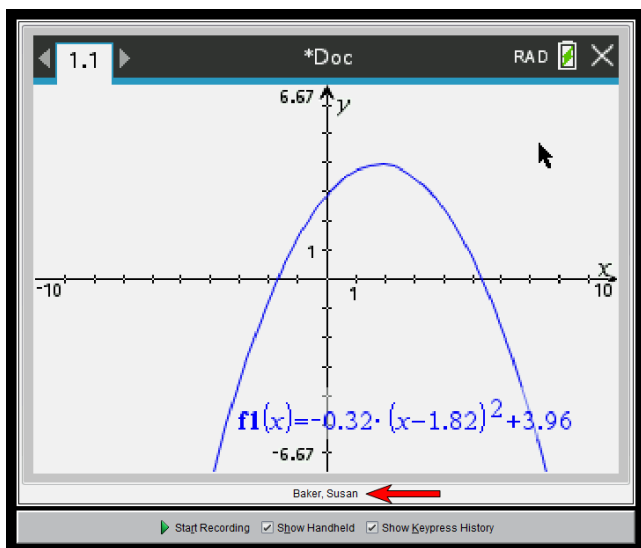

The student name is shown in the same format selected in Capture Class. If you select to show or hide student names in Capture Class, the student name will be shown or hidden when you start Live Presenter.

**Note:** If the handheld is not logged into a class, the handheld ID will display.

To hide the student name in Live Presenter:

- ▶ Clear the **Show Student Names** box.

The student name is hidden.

## Hiding and Showing the Presenter Handheld

By default, the handheld is shown when you start Live Presenter. Showing the handheld enables the class to see which keys are pressed during the presentation. When the handheld is shown:

- The key turns red in the display so that the class can follow along when the presenter presses a key.
- The last key pressed remains highlighted until a different key is pressed.
- The keys on the handheld display cannot be pressed or clicked. This visual display only shows what the presenter presses on their handheld.

### Hiding the Handheld Display

- ▶ To hide the handheld, clear **Show Handheld** in the View Options bar.

The handheld is hidden and the Keypress History is shown in the left pane.

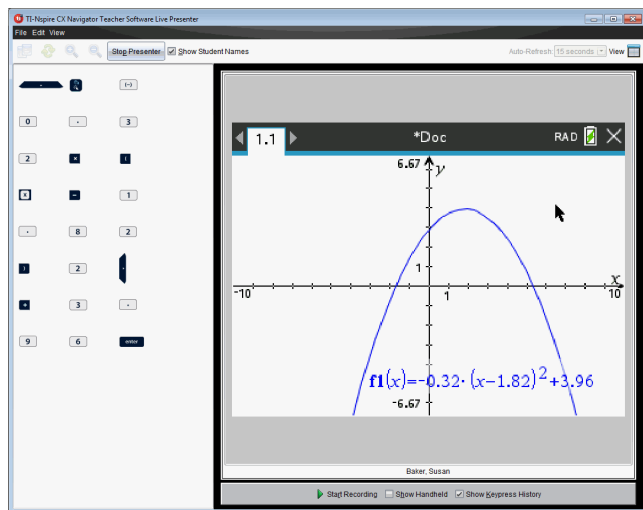

### Showing the Handheld

- ▶ If the handheld is hidden, click **Show Handheld** to show the presenter's handheld in the left pane.

The handheld is displayed in the left pane and the Keypress History pane opens under the handheld screen if selected.

## Viewing Keypress History

By default, the Keypress History pane is open under the handheld screen when you start Live Presenter.

- As keys are pressed during the live presentation, they appear in the Keypress History pane.
- As keys are pressed, they are displayed from left-to-right, and then top-to-bottom.
- If the presenter presses the same key more than once, each repeated key press is shown in the Keypress History pane. If the presenter presses and holds one key (as when moving the cursor), the key is recorded only one time.
- You can copy the keys captured in the Keypress History pane to the Clipboard, and then paste the images into another document. You can also clear the Keypress History pane. (Students are not able to do this.)
- During lengthy live presentation sessions, the keys pressed may expand beyond the display area. When this happens, a scroll bar appears so you can review all keys pressed during the session.

## Hiding Keypress History

- ▶ To hide the Keypress History pane, clear Show Keypress History.

The Keypress History pane closes.

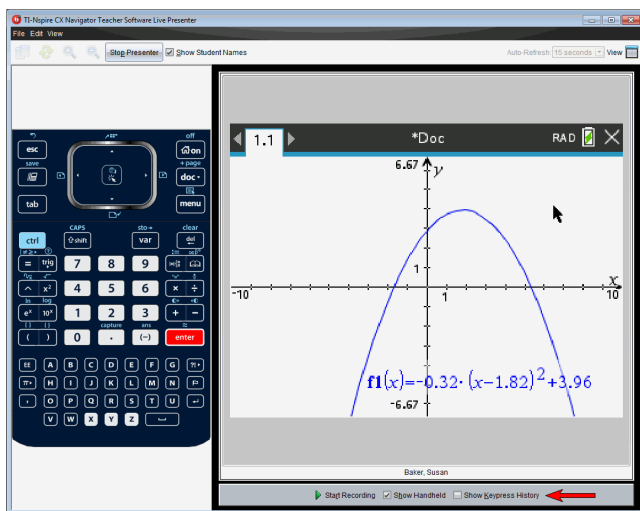

## Showing Keypress History

- ▶ If the Keypress History pane is hidden, check Show Keypress History.

- If the handheld is shown, the Keypress History pane opens below the presenter's handheld screen.
- If the handheld is hidden, the Keypress History is displayed in the pane to the left of the presenter's handheld screen.

### **Copying Keypress History**

You can copy the keys captured in the Keypress History pane to the Clipboard then paste the images of the keys into a Microsoft® Word document or PowerPoint presentation.

1. In the Keypress History pane, select the keys you want to copy.
2. Click **Edit > Copy**.

—or—

Press **Ctrl + C**.

Mac®: **⌘ + C**

Images of the keys are copied to the Clipboard.

### **Clearing Keypress History**

To clear the Keypress History pane:

- ▶ Click **View > Live Presenter > Clear Keypress History**.

The keys displayed in the Keypress History pane are removed.

### ***Showing the Handheld Screen Only***

To show only the presenter's handheld screen during the Live Presenter session:

- ▶ Clear the **Show Handheld** and the **Show Keypress History** options.

The Handheld and Keypress History panes close and the handheld screen is displayed in the window.

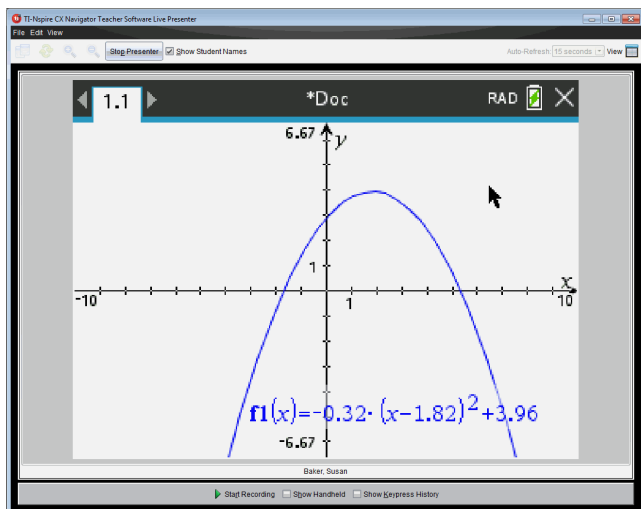

## Recording the Live Presentation

You can record and save the live presentation as a movie (.avi file). Movies are a useful way to present demonstrations to a class, provide additional tutoring for difficult concepts, or provide a way for students who missed the class to review the lesson. When you record the presentation, only the handheld screen is captured. The handheld display and the keys pressed are not recorded. When you save a recorded presentation, the file is saved with the Audio Video Interleave (.avi) file extension.

### Starting the Recording

- ▶ Click the **Start Recording** button.

—or—

Click **View > Live Presenter > Start Recording**.

Recording begins. When clicked, the button changes to **Stop Recording**. All of the presenter's work on the handheld screen is recorded until you stop the recording.

### Stopping and Saving the Recording

Complete the following steps to stop the recording and save the movie file.

1. Click the **Stop Recording** button.

—or—

Click **View > Live Presenter > Stop Recording**.

The Save dialog box opens. The default name for the movie is 'presentation' and the default save location is the class folder for the class that is active. You can change both the file name and the storage location. If you don't want to save the recording, click **Cancel**.

**Note:** If the handheld is not logged into a class, the default movie name is '[date] Recording[number].avi' and the default save location is '[Windows user]\Documents\TI-Nspire\Live Presenter Recordings'.

2. Navigate to the folder where you want to save the .avi file if different from the default folder.
3. Type a new name for the file.
4. Click **Save**.

The file is saved in the designated folder.

### **Playing and Sharing the Recording**

Once the recording is saved as an .avi file, you can play it on your computer. You can also send the file to others as an email attachment.

To play the recording on your computer:

1. Using your file browser, navigate to the folder where you saved the presentation (.avi) file.
2. Double-click the .avi file name.

Your default media player opens and the movie plays.

**Note:** If the .avi file format is not compatible with your default player, an error message is displayed.

### **Stopping Live Presenter**

- ▶ To stop Live Presenter, click the **Stop Presenter** button.

—or—

Click **View > Live Presenter > Stop Presenter**.

The presentation window closes and the Class Workspace is displayed. The class is still active. When you are ready to end the class, click the **End Class** button.

**Note:** If the handheld is not logged into a class, the Content Workspace is displayed.

# Using Question in the Teacher Software

The Question application in the Teacher Software allows you to author multiple choice, open response, equation, expression, coordinate points, lists, image, and chemistry questions.

Although students cannot author questions, they can open documents containing questions, answer these questions, and, in Self-Check mode, check their work.

The Question application is located on the Insert menu in the Documents Workspace.

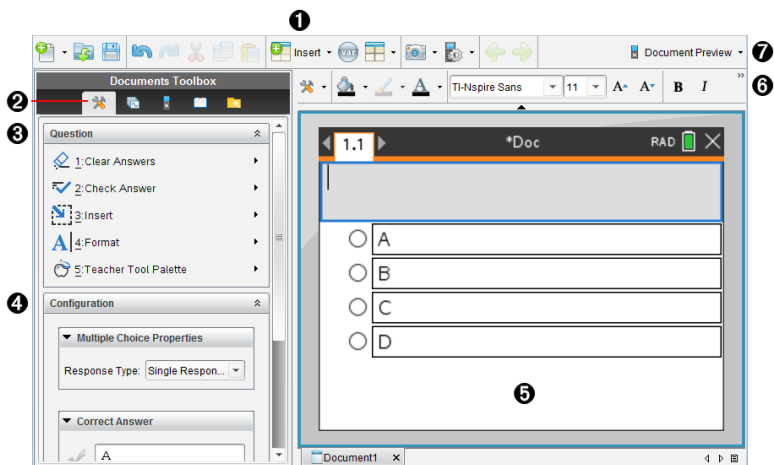





- 1 Insert menu.** Click **Insert** and select **Question** to add a question, or select **Image** to add an image to a question.
- 2 Document Tools.** Click this icon to open the toolbox pane.
- 3 Question tool.** Provides a menu of tools available for working with the Question application.
- 4 Configuration tool.** Allows you to set certain properties for each question you insert.
- 5 Question area.** This is where you type questions and view student responses.
- 6 Formatting toolbar.** Allows you to apply formatting to text.
- 7 Document Preview.** View the document in Handheld or Computer mode. The preview changes, but the page size does not. For more information on Document Preview, see *Working with TI-Nspire™ Documents*.

## Understanding the Question Tools



When you add a question, the Question application opens. If necessary, click Document Tools  to open the tools menu.

**Note:** The Teacher Tool Palette is not available to students.



Tool name		Tool function
	Clear Answers	Lets teachers or students clear the answers in the current question or in the document.
	Check Answer	If you select Self-Check as the document type in the Question Properties dialog box, students can check their answer to the question.
	Insert	Lets teachers or students insert an expression box or chemical equation box into the question or answer.
	Format	Lets teachers or students format the selected text as subscript or superscript. (The chemical equation box uses its own formatting tool, so this Format tool does not work in the chemical equation box.)
	Teacher Tool Palette	Lets you add copyright information and set the document type as Self-Check or Exam.

### Using the Insert Menu

The Insert menu in the Document Tools lets you add math expression boxes  and chemical equation boxes  to the Question area, Suggested Response area, or Correct Answer area of some question types. When you are in question types that allow math expressions or chemical equations, place your cursor where you want to insert the box, and then follow these steps.

1. Open the Question tool.
2. Click **Insert > Expression Box** or **Chem Box**.

The software inserts a blank box where your cursor is positioned.

3. Type the desired math expression or chemical equation, and then click outside of the box to continue typing text.

### Using the Teacher Tool Palette

The Teacher Tool Palette allows you to add copyright information and set the document type as Self-Check or Exam.

#### Adding Copyright Information

Use the Question Properties dialog box to add copyright information to the current question.

1. Click the **Teacher Tool Palette** icon  > **Question Properties**.

The Question Properties dialog box opens.

**Question Properties**

Author

Copyright

Year

Owner

Document Properties

Document Type

2. Type the author's name and move to the **Copyright** field.

**Note:** TI-Nspire™ software allows you to use questions from more than one author in the same document. Therefore, the information that you enter about the author and copyright is not global. You must enter the relevant information for each different question.

3. Select whether the question is public domain or has a copyright assigned to it and move to the **Year** field.
4. Type the year the question was copyrighted and move to the **Owner** field. If you are copyrighting a new question, type the current year (example: 2012).
5. Type the name of the person or entity that owns the copyright.
6. Click **OK**.

### Setting Self-Check and Exam Document Types

When you define a document as Self-Check or Exam, all of the questions in that document will be either Self-Check or Exam.

- When you define the document type as Self-Check, students can check the answers against the answers provided by the teacher.
- In Exam mode, when you enter a suggested response to a question, students cannot check the answers. You can use Exam mode to automatically grade student responses.

1. Click the **Teacher Tool Palette** icon  > **Question Properties**.
2. In the Document Type field, click **Exam** or **Self-Check**.
3. Click **OK**.

### Understanding the Configuration Tool

The Configuration tool allows you to set properties specific to each question type you insert. Properties include the response type, the number of responses (if applicable), the correct answer, and other options.

For example, you can specify the correct answer to a question, and set the scale, axes, and grid on a graph. You can add a 2D math expression on the question types that contain a Correct Answer field.

Each question type has a unique set of options. The options are explained for each question type in the [Adding Questions](#) section.

The configuration settings are retained when you copy and paste a question from one document to another.

### Adding Configuration Options

1. Click the down arrow on the Configuration bar in the Documents Toolbox to open the Configuration tool.

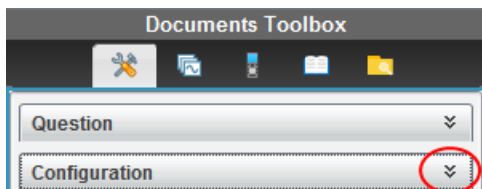

2. Click the down arrow next to the choices you want to edit, and type the applicable text.

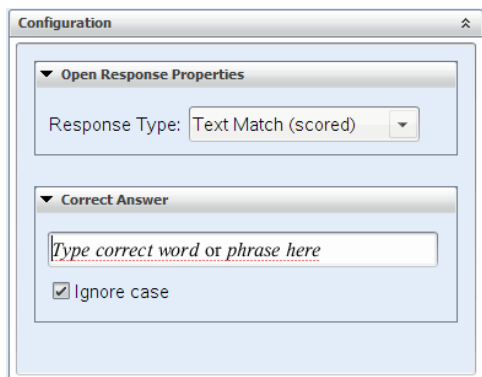

3. Close the Configuration panel. The options you chose are saved when you save the document.

### Formatting Text and Objects

Use the text formatting tools to format text in sections of questions that allow text input.

The formatting toolbar also contains the Document Tools  icon to provide easy access to the Question and Configuration tools.

For more information on formatting text and objects, see [Working with TI-Nspire™ Documents](#).

## Adding Images to Questions

You can add images to the Question Text Area of most questions. On some question types, you can add an image in the Student Answer or Suggested Response Area of a question.

Adding images provides a visual aid to help explain the context of the question, or as a background on a graph.

Choose the image from a set of images on your computer, or copy and paste an image from a different application into the Question Text Area. For more information, see [Working with Images](#).

### Image Types Available

The following file types can be used in the Question application:

- .jpg
- .jpeg
- .bmp
- .png

**Note:** The transparency feature of .png is not supported. Any transparent .png backgrounds will appear as white.

### Adding Images Using the Insert Command

1. Click **Insert > Image**.

The Insert Image dialog box opens.

2. Navigate to the location of the image and select it.
3. Click **Open**.

The image appears in the question.

### Adding Images Using the Clipboard

To copy an image to the Clipboard from a TI-Nspire™ document, image file, or another program, press **Ctrl + C** (Mac®: **⌘ + C**).

To paste the image into the question, press **Ctrl + V** (Mac®: **⌘ + V**).

## Adding Questions

You can add the following types of questions:

- Multiple Choice
  - Custom
  - ABCD
  - True/False
  - Yes/No

- Always/Sometimes/Never
- Agree/Disagree
- Strongly Agree...Strongly Disagree
- Open response
  - Explanation (not auto-graded)
  - Text Match (auto-graded)
- Equations and Expressions
  - $y=$
  - $f(x)=$
  - Expression
- Coordinate Points and Lists
  - $(x,y)$  numerical input
  - Drop Point(s)
  - List(s)
- Image
  - Label
  - Point on
- Chemistry

When you select a question type, a brief explanation of the question is displayed at the bottom of the Choose Question Type dialog box.

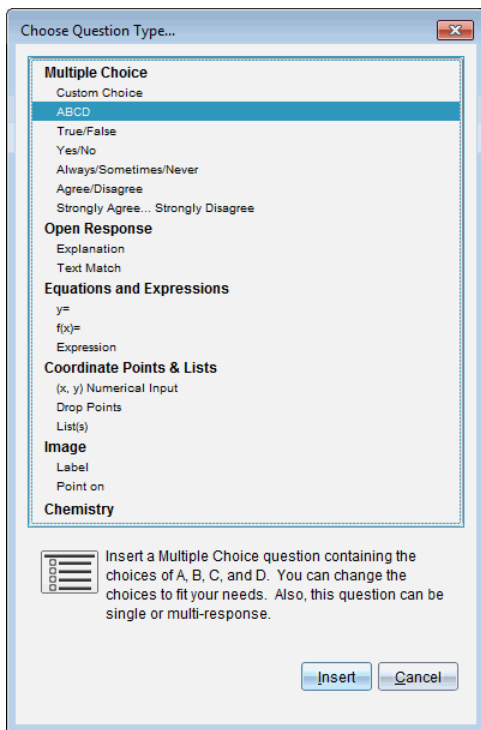

When you open a question template, the cursor is in the Question text area.

### Adding a Multiple Choice Question

This example shows how to add a custom multiple choice question. A custom multiple choice question allows you to specify answers your students can select. You can then select one or more responses as correct to help you when grading or to help students check questions that are in Self-Check mode.

Which of the following are roots of  $x^2 = 9$  ?  
 Mark all that apply.

9

3

-3

-9

3i

-3i

To add a custom multiple-choice question:



This example shows how to add an explanation question.

1. Click **Insert > Question**.

The Choose Question Type dialog box opens.

2. Click **Explanation** under **Open Response**.

3. Click **Insert**.

The Open Response template opens with the cursor in the Question text area.

4. Type the question.

- You can type any combination of text, math expressions, and chemical equations in the Question Area and Suggested Response area.
- You can add an image in the question text area.
- Press **Tab** or use the mouse pointer to navigate between fields.

5. Open the Configuration tool. Select the response type as Explanation or Text Match, and type the correct answer.

- The Explanation response type allows students to give answers that closely match your suggested response.
- The Text Match response type requires students to exactly match your suggested response. Select the **Ignore Case** check box if capitalization is not important.
- You can type any combination of text, math expressions, and chemical equations in the Correct Answer area.

### Adding an Equation Question

An equation question prompts the student to write an equation in the form of  $y=$  or  $f(x)=$ , or to respond with a number or expression.

This example shows how to add a  $y=$  question.

Expand the right side of the equation:  
 $y = (x + 3)(x - 5)$

$y =$

6.67  
y  
1  
x  
-10 1 10  
-6.67

1. Click **Insert > Question**.

The Choose Question Type dialog box opens.

2. Select  **$y=$**  under **Equations and Expressions**.



3. Click **Insert**.

The equation template opens with the cursor in the Question text area.

4. Type the question.

- You can type any combination of text, math expressions, and chemical equations in the Question Area.
- You can add an image in the question text area.
- Press **Tab** or use the mouse pointer to navigate between fields.

5. Enter a suggested response, if desired.

6. Press **Enter** to add other response options, and add the response text.

- Press **Delete** to clear or delete a response.
- Press **Backspace** to delete an empty response line.

7. Open the Configuration tool to set the number of responses, the correct answer, and whether the students should show their work. You can also add a graph that will show in the Question area.

The screenshot shows a 'Configuration' dialog box with two main sections: 'Equation Properties' and 'Correct Answer'.  
In the 'Equation Properties' section, there is a 'Response Type' dropdown set to 'y =', a 'Number of responses' dropdown set to '1', a checked 'Include a Graph Preview' checkbox, a 'Prompt Location' dropdown set to 'LeR', and an unchecked 'Allow students to show their work' checkbox.  
In the 'Correct Answer' section, there is a text field for 'Accepted response(s)' containing the equation  $y = x^2 - 2x - 15$ . To the right of the text field are a blue square icon, a green plus icon, and a red minus icon. Below the text field is an unchecked checkbox labeled 'Accept equivalent responses as c...' and a blue link labeled 'How does this work?'.

- The number of responses can range from 1 to 5.
- The **Show your work** option includes areas for the students to write their starting point, their steps, and their final answer. The option to show work is disabled if multiple responses are allowed.
- To add a graph in the Question area, check **Include a Graph Preview**. The Question text area splits to show a graph on the right.
- When you are in the graph, the Graphs & Geometry toolbox is available to allow you to add functions.

**Note:** Only the teacher can edit the graph. Students can only view and zoom the graph.

- Click **+** to add additional fields for multiple correct answers. For example, you might want to accept both  $y=(x+1)(x+2)$  and  $y=(x+2)(x+1)$  as correct answers.

- Select whether or not to accept equivalent responses as correct.
  - If you *do not* check **Accept equivalent responses as correct**, the student response is marked correct if it is an exact text match to one of the accepted responses you entered.
  - If you *do* check **Accept equivalent responses as correct**, the student response is marked correct if it is equivalent to any accepted response you entered. For example, if you typed  $x+2$  as the correct answer, and the student submits  $2+x$ , this response is equivalent to the accepted response and is automatically graded as correct. Spaces, case differences, and extra parentheses are ignored when the software evaluates student answers. For example,  $y=2x+1$  is evaluated the same as  $Y = 2X + 1$ .

### Adding an Expression Question

An expression question prompts the student to respond with a number value or an expression.

<p>The dog walker earns \$12 per hour, and she spends \$2 on gas getting to and from her client's house. She walks the dog for 30 minutes each day. Write an expression showing how much money she earns in one day.</p>
<p>Enter expression</p>

1. Click **Insert > Question**.

The Choose Question Type dialog box opens.

2. Click **Expression** under **Equations and Expressions**.
3. Click **Insert**.

The expression template opens with the cursor in the Question text area.

4. Type the question.
  - You can type any combination of text, math expressions, and chemical equations in the Question area.
  - You can add an image in the Question area.
5. In the Expression type response, enter a starting expression, if desired. The student sees the starting expression.
6. Enter a suggested response, if desired.
  - If you set the response type as Number, the response fields are math boxes and accept only number values such as  $1/3$ .

- If you set the response type as Expression, the response fields are expression boxes and accept only expression inputs such as  $2(3+5)$ .
7. Open the Configuration tool to set the response type as Number or Expression, set whether or not the students should show their work, and enter a correct answer. You can also set a tolerance for Number types, or equivalent responses for Expression types.

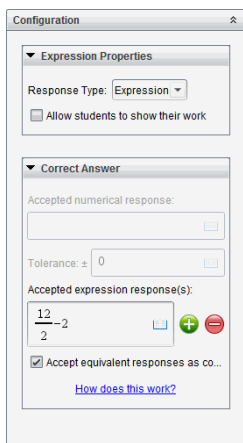

- The **Show your work** option includes areas for the students to write their starting point, their steps, and their final answer.
- In the Number type response, enter the accepted numerical response and the tolerance. Student responses are marked correct if they fall within the tolerance interval you specify.
- Specifying a tolerance of zero indicates you are looking for the exact number answer. Not specifying a tolerance is the same as specifying a tolerance of zero.
- Student answers are considered correct if they are numerically equivalent to the correct answer. Spaces, case differences, and extra parentheses are ignored when the software evaluates student answers.
- In the Expression type response, you can add additional fields (up to 10) for multiple correct answers.
- In the Expression type response, click  to open the Templates and Symbols catalog that allows you to enter 2D math expressions.
- In the Expression type response, you can select whether or not to accept equivalent responses as correct.
  - If you *do not* check **Accept equivalent responses as correct**, the student response is marked correct if it is an exact text match to one of the accepted responses you entered.
  - If you *do* check **Accept equivalent responses as correct**, the student response is marked correct if it is equivalent to any accepted response you entered. For example, if you typed  $x+2$  as the correct answer, and the student submits  $2+x$ , this response is equivalent to the accepted response and is

automatically graded as correct. Spaces, case differences, and extra parentheses are ignored when the software evaluates student answers. For example,  $x+2$  is evaluated the same as  $X + 2$ .

**Important:** Students can enter the starting expression you supply and have this response automatically graded as correct. For example, if you ask students to factor  $x^2-7x+12$  and stipulate the correct answer is  $(x-3)(x-4)$ , the student can submit a response of  $x^2-7x+12$ . This response is automatically graded as correct because it is equivalent to the accepted answer. You must manually mark this student response as incorrect in either the Review or Portfolio Workspaces. See the chapters for those workspaces for more information on marking and grading responses.

### Adding an (x,y) Numerical Input Question

An (x,y) numerical input question prompts the student to respond with a coordinate.

Write the ordered pair for each given point in order: J, N, P

( ) ( )  
( ) ( )  
( ) ( )

10 y  
N  
1  
-10  
-10 1 10  
J -10  
P

1. Click **Insert > Question**.

The Choose Question Type dialog box opens.

2. Click **(x,y) Numerical Input** under **Coordinate Points & Lists**.
3. Click **Insert**.

The template opens with the cursor in the Question text area.

4. Type the question.
  - You can type any combination of text, math expressions, and chemical equations in the Question area.
  - You can add an image in the Question area.
  - Press **Tab** or use the mouse pointer to navigate between fields.
5. Enter a suggested response, if desired.
  - The response fields are expression boxes and accept only expression inputs.
6. Press **Enter** to add other response options (up to five), and add the response text.
  - Press **Delete** to clear or delete a response.
  - Press **Backspace** to delete an empty response line.

- Open the Configuration tool to set the number of points, add a graph preview, enter a correct answer, and set equivalent responses as correct.

The screenshot shows the Configuration tool interface. It is divided into two main sections: 'Coordinate Point Properties' and 'Correct Answer'.

**Coordinate Point Properties:**

- Number of Points: 3 (dropdown menu)
- Include a Graph Preview
- Prompt Location: Left (dropdown menu)

**Correct Answer:**

Acceptable Answer(s):

- ( -5 , -6 ) with + and - buttons
- ( 3 , 6 ) with + and - buttons
- ( 6 , -4 ) with + and - buttons

Accept equivalent responses as c...

- The number of points can range from 1 to 5.
- Click **+** to add additional fields for multiple correct answers. You can type any combination of text, math expressions, and chemical equations in the correct answer fields.
- Click  to open the Templates and Symbols catalog that allows you to enter 2D math expressions.
- To add a graph in the Question area, select **Include a Graph Preview**. The Question text area splits to show a graph on the right and the student prompt area on the left. To change the location of the graph, click the down arrow next to **Prompt Location** and choose the desired location for the graph in the student prompt area.
- When you are in the graph, the Graphs & Geometry tools are available to allow you to add functions.

**Note:** Only the teacher can edit the graph. Students can only view and zoom the graph.

- Select whether or not to accept equivalent responses as correct.
  - If you *do not* check **Accept equivalent responses as correct**, the student response is marked correct if it is an exact text match to one of the accepted responses you entered.
  - If you *do* check **Accept equivalent responses as correct**, the student response is marked correct if it is equivalent to any accepted response you entered. For example, if you typed (-0.5, .75) as the correct answer, and the student submits (-.5, .75) or (-1/2, 3/4), and so forth, the student response is equivalent to the accepted response and is automatically graded as correct.

## Adding a Drop Points Question

A drop points question inserts a graph and prompts the student to drop points on the graph in response to your question.

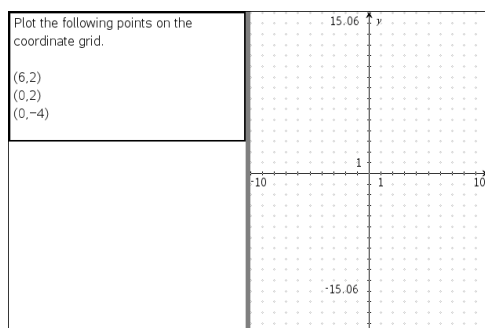

1. Click **Insert > Question**.

The Choose Question Type dialog box opens.

2. Select **Drop Points** under **Coordinate Points & Lists**.

3. Click **Insert**.

The drop points template opens with the cursor in the Question text area.

The graph is in the Student answer area.

- When you are in the graph, the Graphs & Geometry tools are available to allow you to add functions.

**Note:** Only the teacher can edit the graph. Students can only view, zoom, or place points on the graph.

4. Type the question.

- You can type any combination of text, math expressions, and chemical equations in the Question area.
- You can add an image in the Question Area.
- Press **Tab** or use the mouse pointer to navigate between fields.

5. Open the Configuration tool to set the number of points, hide or show coordinates, and enter a correct answer.

- The number of points can range from 1 to 5.
- Showing coordinates is turned off by default. Select the check box to display coordinate labels on the graph.
- Click **+** to add additional fields for multiple correct answers. You can type any combination of text, math expressions, and chemical equations in the correct answer fields.

- Click  to open the Templates and Symbols catalog that allows you to enter 2D math expressions.

### Adding a Lists Question

A Lists question inserts a list and prompts students to enter data in the lists in response to your question.

Submit the following data – distance in miles between home and work (distance) and the travel time in minutes (time)	A distance	B time	
	1		
2			
3			
4			
5			
6			
7			
8			
9			
10			
11			
12			
13			
14			
15			

1. Click **Insert > Question**.

The Choose Question Type dialog box opens.

2. Select **List(s)** under the **Coordinate Points & Lists** question from the Choose Question Type dialog box.

3. Click **Insert**.

The List template opens with the cursor in the Question text area.

4. Type the question.

- You can add columns or rows, change the name of the lists, and input data in the lists, using the same functions allowed in the Lists & Spreadsheet application.

5. Enter initial data in the lists, if desired.

6. Open the Configuration tool to set the number of lists for the student responses.

- The number of lists can range from 1 to 5.
- Lists must have names. The default names are **List1**, **List2**, and so forth.

### Adding an Image: Label Question

An Image: Label question inserts an image. You can add blank fields to the image and have students fill in the blanks in response to your question.

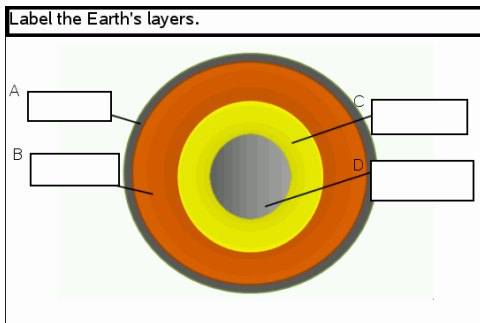

1. Click **Insert > Question**.

The Choose Question Type dialog box opens.

2. Select **Label** under **Image**.

3. Click **Insert**.

The Image: Label template opens with a blank background and one label. This is where the image for the question is inserted.

4. Type the question.

- You can type any combination of text, math expressions, and chemical equations in the Question area.
- Press **Tab** or use the mouse pointer to navigate between fields.

5. Insert an image in the bottom portion of the question template.

6. Open the Configuration tool to set the number of responses and to enter answers for each label.

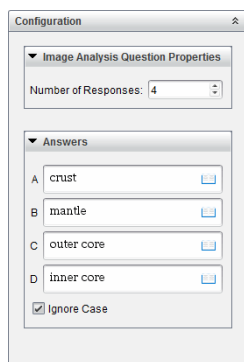

- The number of responses determines the number of labels on the image. Each new response gives the label a unique identifier, such as A, B, C, and so forth. Drag the labels to the desired location on the image.



**Note:** If you set more than 26 responses, the labels are identified with numbers, starting with 1. You can insert a maximum of 35 labels.

- In the answers area, click  to open the Templates and Symbols catalog that allows you to enter 2D math expressions.
  - If the label text is too large to fit in the default label size, grab and drag the borders of the label to resize it.
7. Type a suggested response in the labels, if desired. Select the **Ignore case** check box if capitalization is not important.
- You can type any combination of text, math expressions, and chemical equations in the response area.
  - As you type the suggested response, a ghosted image of your answer appears in the respective label on the image. If the suggested response is too large for the default label size, grab and drag the borders of the label to resize it.

### Adding an Image: Point on Question

An Image: Point on question inserts an image. Add check boxes to the image and have students place a check mark in the correct boxes in response to your question.

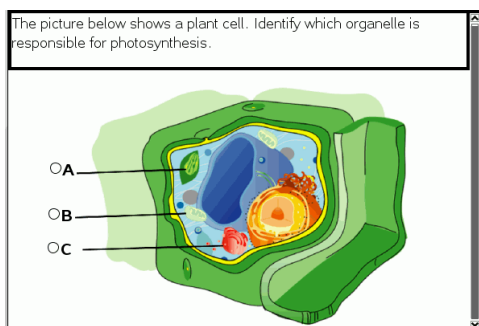

1. Click **Insert > Question**.

The Choose Question Type dialog box opens.

2. Select **Point on** under **Image**.
3. Click **Insert**.

The Image: Point on template opens with a blank background and one point. This is where the image for the question is inserted.

4. Type the question.
  - You can type any combination of text, math expressions, and chemical equations in the Question area.
  - Press **Tab** or use the mouse pointer to navigate between fields.
5. Open the Configuration tool to set the response type, number of responses, and correct answer.

- The Response Type makes the point a circle for Single Response and changes to a square for Multiple Responses to indicate students can select more than one box.
- The number of responses determines the number of points on the image. Each new response gives the point a unique identifier, such as A, B, C, and so forth. Drag the points to the desired location on the image.

**Note:** If you set more than 26 responses, the points are identified with numbers, starting with 1. You can insert a maximum of 35 points.

6. Click a point or points as a suggested response, if desired.

### Adding a Chemistry Question

When you add a Chemistry question, students respond with a chemical formula or equation.

Balance the following equation: $\_\_\_ \text{N}_2 + \_\_\_ \text{H}_2 \rightarrow \_\_\_ \text{NH}_3$
Student: enter chemical notation here.

1. Click **Insert > Question**.

The Choose Question Type dialog box opens.

2. Click **Chemistry**.

3. Click **Insert**.

The Chemistry template opens with the cursor in the Question text area.

4. Type the question.

- You can type any combination of text, math expressions, and chemical equations in the Question area.
- You can add an image in the Question area.

5. Enter a suggested response, if desired.

6. Open the Configuration tool to enter a correct answer.

Click  to add additional fields for multiple correct answers. You should enter all possible answers. The software does not evaluate equivalency for Chemistry answers.

## Responding to Questions





The teacher may send you several different question types. This section shows you how to answer the different question types.

### ***Understanding the Question Toolbar***

When you open a document with a question, a toolbar is available with four options. Access the toolbar using the following method.

► In the Documents Toolbox, click .

Handheld: press menu.

Tool name	Tool function	
	Clear Answers	Lets you clear the answers in the current question or in the document.
	Check Answer	If the teacher enabled Self-Check mode for the question, click here to view the correct answer.
	Insert	Lets you insert a math expression box or chemical equation box in your answer.
	Format	Click this tool to format the selected text in your answer as subscript or superscript. (The chemical equation box uses its own formatting tool, so this Format tool does not work in the chemical equation box.)

### ***Types of Questions***

There are several types of questions you may be asked. There may be variations in a type, but how you answer the question is basically the same for each type.

- Multiple Choice
  - Custom
  - ABCD
  - True/False
  - Yes/No
  - Always/Sometimes/Never
  - Agree/Disagree
  - Strongly Agree...Strongly Disagree
- Open response
  - Explanation (not auto-graded)
  - Text Match (auto-graded)

- Equations and Expressions
  - $y=$
  - $f(x)=$
  - Expression
- Coordinate Points and Lists
  - $(x,y)$  numerical input
  - Drop Point(s)
  - List(s)
- Image
  - Label
  - Point on
- Chemistry

### ***Responding to Quick Poll Questions***

When teachers send quick polls during class, the question opens as a new document on top of any document you may currently have open. You can access other applications to perform calculations, and check or clear answers before submitting your answer to the question or quick poll.

**Note:** On TI-Nspire™ CX or TI-Nspire™ CX CAS handhelds, questions appear in color if the teacher applied color when writing the question. Although you can see color in the questions you receive, you cannot add color to the responses you submit.

### **Accessing Other Applications**

If the teacher gives permission, the Quick Poll tool allows you to temporarily exit the question to perform calculations or access other documents to determine the answer to the question. For example, you can access the Scratchpad to perform a calculation, or you can access the Lists & Spreadsheet application and copy data from there to a List question type. In a List question, you can link to variables from the Vernier DataQuest™ or Lists & Spreadsheet applications.

To access other applications while in the Quick Poll screen:

1. Open a new document.

Handheld: Press  to open the **Home** screen.

2. Choose an application.

Handheld: To return to the Quick Poll without accessing any documents, choose **C: Quick Poll**.

3. When you are finished, click the Quick Poll icon.

When you respond to a poll, your response is immediately sent to the teacher's computer and teachers can track student responses in real time.

## Showing Your Work

The teacher may request you to show work for your response. If so, the response area has sections for you to write your starting point, your steps, and the final answer.

### Responding to Different Question Types

- ▶ For Multiple Choice questions, press **Tab** to navigate to a response. Press **Enter** to mark a response.
- ▶ For Open Response questions, type a response.
- ▶ For Equation questions, type a response. If a graph is included in a question, the graph updates when you press **Enter**. Any functions entered show up on the graph, and the cursor remains in the answer box. You cannot manipulate the graph itself.
- ▶ For Expression questions, type a response. If the response type is Number, your response must be in the form of a number. If the response type is Expression, your response must be in the form of an expression. For example,  $x+1$ .
- ▶ For Coordinate Points: (x,y) questions, type an answer in the x-field box, and press **Tab** to move to the y-field box. Type an answer.

If a graph is included with the question, the graph is updated when you enter a function and press **Enter**.

You can access the Window and Zoom functions while you are working on the graph.

- ▶ For Coordinate Points: Drop Points questions, press **Tab** to move the cursor to a point on the graph. Press **Enter** to drop a point at that location.

To delete a point, press **Ctrl + Z** to undo the action.

- ▶ For Lists questions, press **Tab** if necessary to move the cursor to the first cell of the list. Type an answer, and press **Tab** to move to the next cell. Type an answer.

To link a column to an existing variable, select the column and then click **var**. Click **Link To**, and then click the variable you want to link to.

The behavior in a Lists question closely matches the behavior of the Lists & Spreadsheet application, with the following exceptions. In a Lists question, you cannot:

- Add, insert, or delete columns.
  - Change the header row.
  - Enter formulas.
  - Switch to Table.
  - Create plots.
- ▶ For Chemistry questions, type a response.
  - ▶ For Image: Label questions, press **Tab** to move the cursor to a label on the image. Type a response in the label field.

- For Image: Point on questions, press **Tab** to move the cursor to a point on the image. Press **Enter** to mark a response.

### Checking Answers

If the teacher enables self-check on the question, the Check Answer option is available.

1. Click .

Handheld: Press .

2. Click **Check Answer**.

### Clearing Answers

After you answer a quick poll, you may decide you want to change the answer before you submit it.

- Click **Menu > Clear Answers > Current Question** or **Document**.

- **Current Question** clears answers for the active question.
- **Document** clears answers for all questions contained in the active document.

—or—

If you answered the question, you still have time to clear the answer before you submit it to your teacher.

- Click **Clear Answer** to clear your answer and try again.

Handheld: Press  and choose **Clear Answer**.

### Submitting Responses

To send a final answer to the teacher:

- Click **Submit Response**.

Handheld: Press  and choose **Submit**.

The response is sent to the teacher and the last screen you used is displayed.

Your response appears on the teacher's computer. Your teacher may have set the poll to allow you to submit more than one answer. If so, you can continue to respond to the poll and submit answers until the teacher stops the poll.

# Polling Students

The Quick Poll tool lets you “poll” your students. A poll is a survey you send to students that they immediately receive on their handhelds or laptops. After students receive the poll, they can send responses back to your computer. Quick Poll is available from all workspaces. As you receive student responses, use the Review Workspace to review the responses.

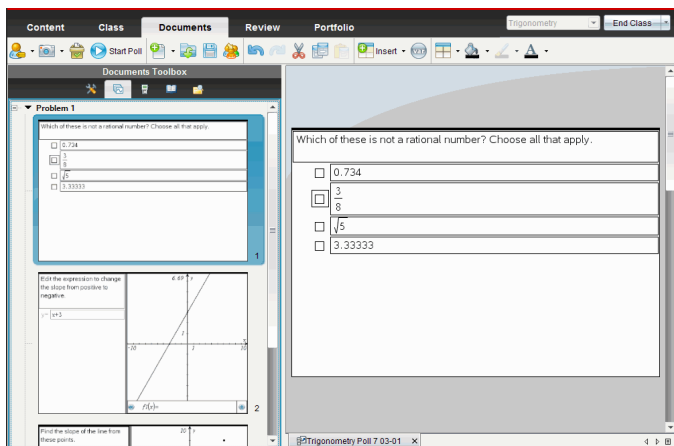

When you click the Quick Poll icon  from any workspace, the Documents Workspace opens, and you can start the Quick Poll. Starting the Quick Poll opens the Review Workspace. You can switch to any workspace while a poll is in progress, but you can only stop the poll from the Documents or Review Workspaces.

You can send the following types of questions:

- Multiple Choice
  - Custom Choice
  - ABCD
  - True/False
  - Yes/No
  - Always/Sometimes/Never
  - Agree/Disagree
  - Strongly Agree...Strongly Disagree
- Open response
  - Explanation (not auto-graded)
  - Text Match (auto-graded)
- Equations and Expressions
  - $y=$

- $f(x)=$
- Expression
- Coordinate Points and Lists
  - (x,y) Numerical Input
  - Drop Points
  - List(s)
- Image
  - Label
  - Point on
- Chemistry

When you select a question type, a brief explanation of the question is displayed at the bottom of the Choose Question Type dialog box.

### ***Opening the Quick Poll Tool***

You can open the Quick Poll tool from any workspace. You can send a poll from an existing document, or open a new document to start a poll.

Before you begin, make sure a class is in session.

1. Click **Tools > Quick Poll** or click  .

The Choose Question Type dialog box opens.



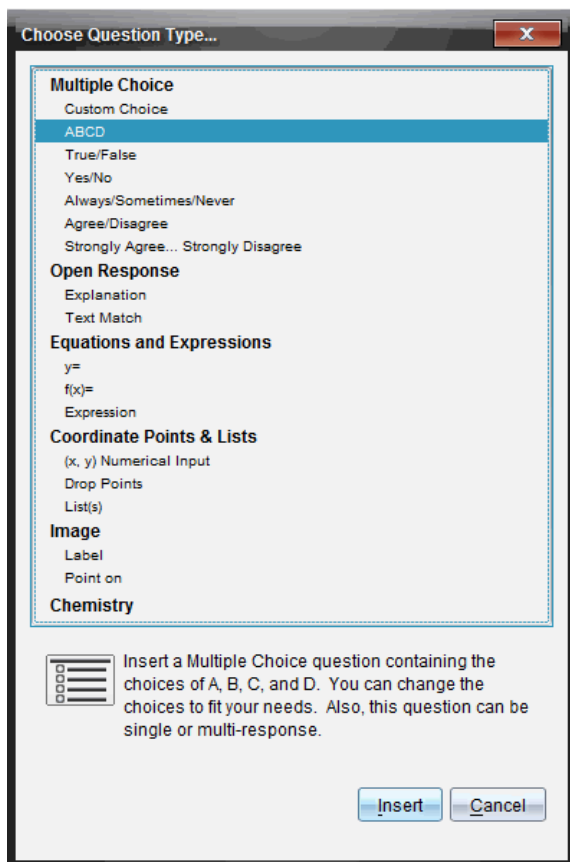

2. Select a question type and click **Insert**.

A new document opens with the question template open and the cursor in the Question text area.

A screenshot of a Quick Poll question interface. At the top, there is a text input field. Below it, there are two radio button options: "True" and "False". The interface is enclosed in a rectangular border.

Quick Poll documents are named <Class name, Quick Poll Set#, mm-dd.tns>. For example: Algebra1 - Mrs. Smith QP2 10-26.tns. You can rename the poll when you save it.

**Note:** All Quick Polls for one class session are contained in one tab in the Documents Workspace. A new tab is started when the number of questions in the poll exceeds 30, or when you start a new class session.

**Note:** For more information about question types and about creating and configuring questions, see [Using Question in the Teacher Software](#).

## ***Sending a Quick Poll***

After you have selected the Quick Poll question, entered the information, and selected options, you are ready to send the poll to your students.

► To send the Quick Poll question, click **Start Poll** .

The poll is immediately sent to students. The Quick Poll interrupts the active TI-Nspire™ document, and the poll becomes the active document.

You can stop a poll and restart it at any time.

### **Using Quick Poll Options**

When Quick Poll is active, the **Tools > Quick Poll Options** menu is enabled.

- **Allow Document Access.** Allows you to grant or deny students access to the Scratchpad and any documents on their handheld. The students may access a document, do some math, and copy the results back into the poll.

**Note:** If a data collection sensor is attached to the computer or handheld during a Quick Poll that does not have Allow Document Access turned on, the Quick Poll is dismissed and the data collection console becomes active.

- **Allow Resubmit.** Allows the students to submit their responses several times.

## Stopping Polls

You can stop polls at any time. Your students do not need to do anything on their handhelds or computers to stop the poll. When you stop a poll, the students can no longer submit answers.

- ▶ To stop a poll, click **Stop Poll**  .



**Note:** If you pause a class while a Quick Poll is running, the Quick Poll remains on the students' handhelds, but students are not able to answer or submit the poll until you resume the class.

## Resending Polls

You can resend a poll from the Review Workspace, without switching workspaces or starting a new question.

The software treats the resent poll like a new poll. Students receive a new poll on top of the open document on their handheld or laptop.

The data from the poll is treated as new data, and does not overwrite any data from the original poll.

- ▶ To resend the same poll you just sent, click **Start Poll**  .
- ▶ To resend a previous poll, click the poll in the page sorter and then click **Start Poll**  .

The poll is added to the page sorter in the order it was sent. The page sorter indicates it was resent.

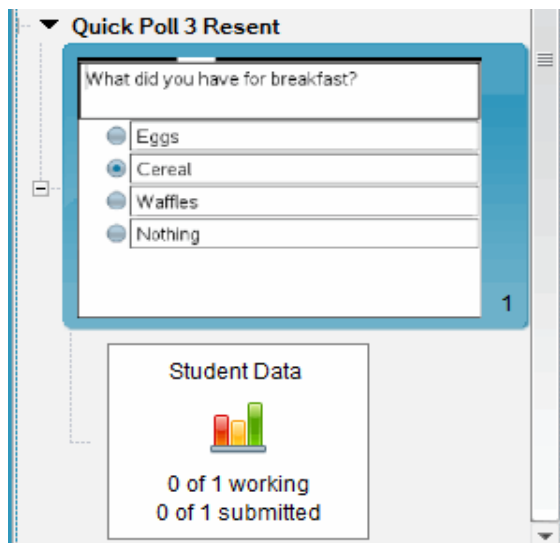

**Quick Poll 3 Resent**

What did you have for breakfast?

- Eggs
- Cereal
- Waffles
- Nothing

1

**Student Data**



0 of 1 working  
0 of 1 submitted

## ***Sending Polls to Missing Students***

You can send the most recent poll to students who were not logged in before the poll was stopped.

**Note:** The Send to Missing option can only be used with the last poll that was sent.

1. In the page sorter, click the last poll that was sent.
2. Click **File > Send to Missing**.

The poll is immediately sent to students who were not logged in when the poll was sent previously, but are currently logged in.

The data gathered from the missing students is added to the data from the last poll.

## ***Saving Polls***

You can save Quick Poll results to the Portfolio Workspace while the poll is still in progress, or you can save a completed set of Quick Poll documents as a .tns file.

You can save to the Portfolio Workspace from either the Class Workspace or the Review Workspace.

When you save the results to the Portfolio Workspace, the polls sent in one class session are saved in one column.

A new column is started when a poll exceeds 30 questions, or when you start a new class session.

- ▶ To save a Quick Poll to the Portfolio Workspace, click **File > Save to Portfolio**.

**Note:** After the first save, subsequent changes to the poll are automatically updated in the Portfolio Workspace until you stop the poll.

You can also save a set of Quick Polls as a Master Document (.tns file). A Master Document contains information that can be used as the answer key for evaluating responses collected from students.

- ▶ To save a Quick Poll as a Master Document, click **File > Save Quick Poll Set as Document**.

**Note:** After you save as a .tns file, any subsequent changes to the poll are not updated in the .tns document.

## ***Viewing Poll Results***

Review Quick Poll results in the Review Workspace.

Polls sent in one class session are contained in a Quick Poll tab in the Review Workspace. Each new question is added as a new problem in the page sorter, and the software automatically opens to the last question that was sent. A new tab is started when a poll exceeds 30 questions.

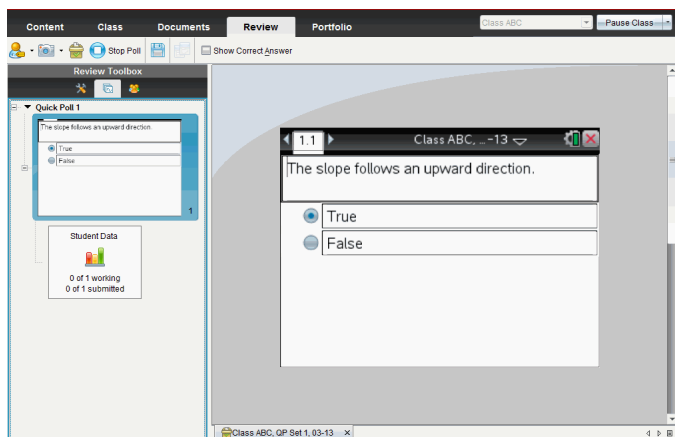

You can view the results as a bar chart, graph, or table. The results automatically update as students send their responses, until you stop the poll.

The following example shows the poll results listed in a table.

Student	Response
Chopra, Laxmi	$y=3-x$
Garcia, Rafe	$y=x-3$
Moore, Jacob	$y=x+3$
Ortega, Carlos	$y=3-x$
Simmons, Nadine	$y=3-x$

For more information about viewing and sorting poll results, see [Using the Review Workspace](#).

## Using the Review Workspace

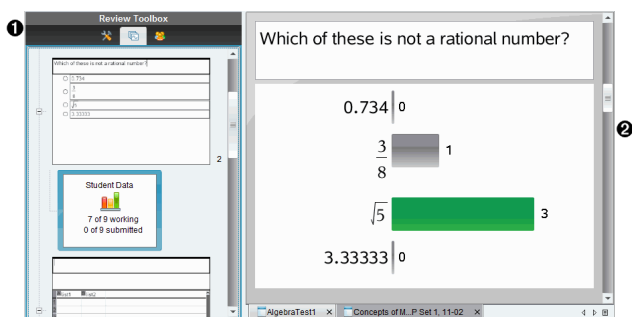

Use this workspace to review a collected set of documents, manage student responses, run live activities, and organize data.



- 1 Review toolbox.** Contains the Review Tools, Page Sorter, and Student Response tools. Click each icon to access the available tools. Options for the selected tool are displayed in the toolbox pane.
- 2 Data View pane.** Shows the data and options from the poll or document you have selected in the Review Toolbox. You can switch the data view between bar chart, table, and graph (if available).  
The software retains the data view that was set for each question when you close and reopen the Review Workspace. All hidden and unhidden data, settings in graph view, table view, bar chart view, and Show Your Work are retained when you close the Review Workspace.

## Using the Review Toolbox

The Review toolbox contains tools needed for working with collected documents, Question results, and Quick Poll results.

Icon	What you can do
 <b>Review tools</b>	The Review tools let you organize the response data, use graph tools, hide or show responses, and mark Question and Quick Poll responses as correct or incorrect.
 <b>Page sorter</b>	Displays all the problems in a document or Quick Poll, all the pages in each problem, and the student responses for each question in the document.
 <b>Student pane</b>	Displays the student names and responses in the Data View pane.

## Exploring the Review Tools

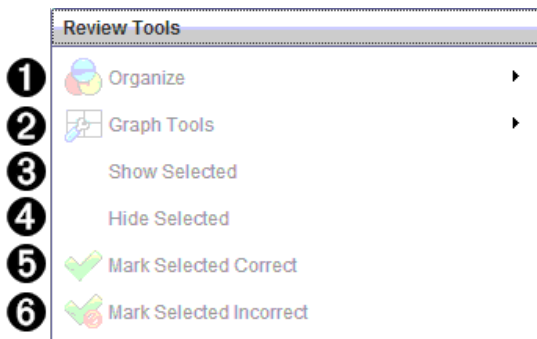

- 1 **Organize.** Click ► to organize the data in different views.
- 2 **Graph Tools.** Click ► to access the graph tools when you are in coordinate graph view.
- 3 **Show Selected.** Shows selected responses for review in the Data View pane.
- 4 **Hide Selected.** Hides selected responses in the Data View pane.
- 5 **Mark Selected Correct.** Select a response from the Data View pane and click **Mark Selected Correct** to mark that response as the correct answer. You can mark more than one answer as a correct answer.
- 6 **Mark Selected Incorrect.** Select a response from the Data View pane and click **Mark Selected Incorrect** to mark that response as an incorrect answer. You can mark more than one answer as an incorrect answer.

## Exploring the Page Sorter

Use the Page Sorter to view student responses to any question in a document.

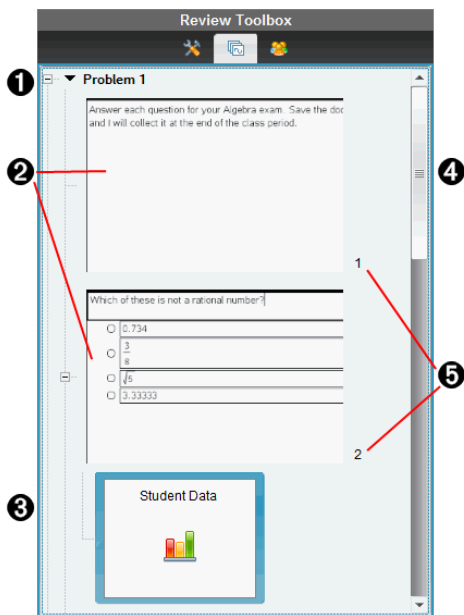

- ❶ Click the minus sign (–) to collapse the view. Click the plus sign (+) to expand the view and show all the pages in a problem, and all the problems in a document.
- ❷ The pages in a problem. Click a page to open it in the Data View pane.
- ❸ **Student responses.** A student data icon follows each question in the document. Click the icon to view the student responses for the question in the Data View pane. In Quick Polls, the icon shows the number of students who were logged in when the poll was started, the number who have responded, and the number who have submitted their answer. In the example below, nine students were logged in when the poll was started, seven students responded to the poll, and no students have submitted their answer.

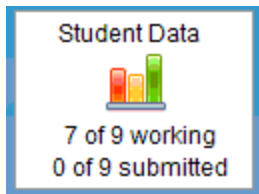

**Note:** If you send a poll to students who were missing, the numbers may change.

- ❹ **Scroll bar.** The scroll bar is active when there are too many pages to show in the panel.
- ❺ **Page numbers.** Click a page number to open the page in the Data View pane.



## Exploring the Student Pane

Use the Student pane to:

- Display the students to whom the file was sent
- View the students who responded
- View student responses
- Mark responses as correct or incorrect
- Sort the responses by student or response, or by time in Quick Polls

Student	Response	Time
<input checked="" type="checkbox"/> Baker, Susan	√5	11:50:18
<input checked="" type="checkbox"/> Chopra, Laxmi	0.734	11:50:14
<input checked="" type="checkbox"/> Huang, Shen	√5	11:50:36
<input checked="" type="checkbox"/> Kapur, Samir	√5	11:50:05
<input checked="" type="checkbox"/> Li, Song	√5	11:50:32
<input checked="" type="checkbox"/> Lopez, Maria		
<input checked="" type="checkbox"/> Moore, Jacob	√5	11:50:28
<input checked="" type="checkbox"/> Simmons, Nadine		
<input checked="" type="checkbox"/> Thompson, Olivia	$\frac{3}{8}$	11:50:25

- 1 Display Student Responses.** Select this check box to show the responses of each student. Clear the check box to hide the student responses.
- 2 Student, Response, and Time columns.** The Time column is available only in Quick Poll reviews.
  - Click the Student column to list the students in alphabetical order. Click again to list in reverse alphabetical order.
  - Click the Response column to list the responses in alphabetical or numerical order. Click again to list the responses in reverse order.
  - To add the Time column in Quick Poll reviews, click the Options menu , and then click **Time**.
  - Click the Time column to list the responses in order of the time they were answered (first response on top). Click again to list the responses with the first response on the bottom.
- 3 Student names.** Lists all students in the class associated with the document currently opened for review. The student names are displayed as chosen in the **Class >Student**

**Name Format** menu.

Student names in red text indicate students who did not receive the file or respond to the Quick Poll.

- 4 **Responses.** Lists all responses next to the student's name. A student may be listed several times if they gave multiple responses. The Response column may change if the review document is an active Quick Poll or a question document that has not been saved yet.
  - A response is shown if the student responded.
  - The response area is blank if the student did not respond.
  - "Responded" is displayed if the student responded and the responses are hidden.
  - "No Response" is displayed if the student has not yet responded to the open question or active Quick Poll.
  - "Working" is displayed if the student has modified their response to a Quick Poll, but has not submitted it.
- 5 **Options menu.** Click ▼ to open the menu of options you can perform on the student responses:
  - Display student responses.
  - Display student names only.
  - Display responses only.
  - Display a Time column for Quick Poll results.
  - Select all items in the list.
  - Show the selected item.
  - Hide the selected item.
  - Mark one or more responses as correct.
  - Mark one or more responses as incorrect.

## Exploring the Data View Pane

1

2

3

- 1 Show Correct Answer.** Select this check box to display the answer you marked as the correct answer in the Data View pane. The correct answer is highlighted in green.
- 2 Responses.** Shows the information chosen in the Page Sorter. This example shows the responses from a selected Student Response icon. You can show or hide responses, and mark responses as correct or incorrect.
- 3 Data View.** Click an icon to view the data in different formats: bar chart, graph, or table. A "Show Your Work" option is available for expression and equation questions.

### Understanding the Data View

The Data View pane displays the question in the open document, as well as the responses to that question. You can view live results in the Data View pane. The data is updated in real time as students respond to Quick Poll and Open Response questions, graph functions, or move points on a graph.

The Data View icons allow you to view responses in the Data View pane as a bar chart, graph, or table. Each view shows the student responses and the frequency of each response.

The bar chart and table views are available for all question types and Quick Poll documents. The graph view is available in equation, coordinate points, and list questions.

Expression and equation questions have an additional "Show Your Work" data view available, if you marked the question for students to show their work. The "Show Your Work" data view is retained when you close and reopen the Review Workspace.

The following examples show the same data displayed in different data views.

Click  to view the data in bar chart form.

$$y=x+3$$

$$y=x+1$$

$$y=x-3$$

Click  to view the data in graph form.

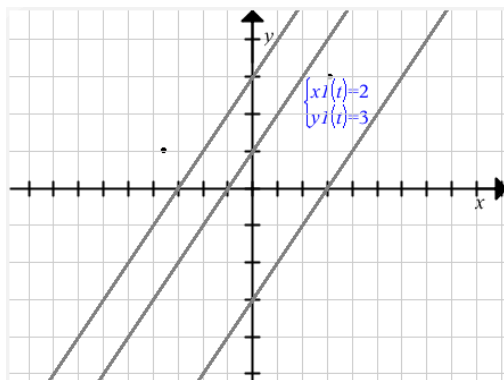

When you are in graph view, the Graph Tools are available to allow you to work with the graph. The settings in the graph are retained when you close and reopen the Review Workspace.

In the bar chart and graph views, hover your mouse pointer over a response to see a list of students who gave that response.

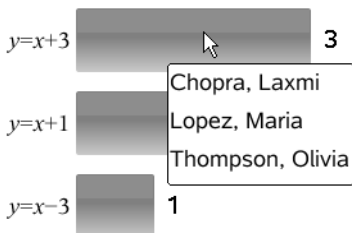

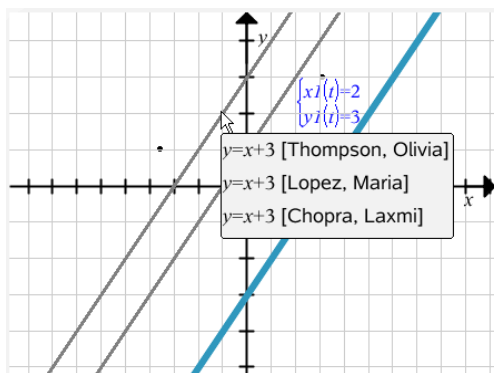

Click  to view the data in table form.

The table view is available as a frequency table or as a student table.

- To view data in different table views, click the Organize tool in the Review toolbox, and then click **Frequency Table** or **Student Table**.

A frequency table shows the responses with the number of times the response occurred. Click the Response heading to sort the responses in ascending order, descending order, or question order. Click the Frequency heading to sort by frequency of response.

Response	Frequency
$y=3-x$	3
$y=x-3$	1
$y=x+3$	1

A student table shows the student names with their responses. Click the Student heading to sort the responses in ascending or descending alphabetical order. Click the Response heading to sort the responses in ascending order, descending order, or question order.

Student	Response
Chopra, Laxmi	$y=3-x$
Garcia, Rafe	$y=x-3$
Moore, Jacob	$y=x+3$
Ortega, Carlos	$y=3-x$
Simmons, Nadine	$y=3-x$

The settings for sorting and sizing columns are retained for each document when you close and reopen the Review Workspace.

### **Opening Documents for Review**

You can review a document that has been collected from the class, a Quick Poll in progress, or a saved Quick Poll. You cannot review a document that does not have questions.

When you start a Quick Poll, the software automatically switches to the Review Workspace, and you can review the data as the students are responding. When you stop and save the poll, you can open it in the Review Workspace to review the saved responses.



If this is your first time using the software, the Data View pane may be empty. Complete the following steps to open a document for review.

#### **Opening a Document from the Class Workspace**

To open a document for review from the Class Workspace:

1. Use the Workspace selector to select the Class Workspace.
2. Right-click a file from the Class Record, and then click **Open in Review workspace**.

The software automatically switches to the Review Workspace with the selected document open.

**Note:** You can open collected documents  that contain questions and Quick Polls  for review in the Class Record.

Class Record		
Action	File Name	Status
	AlgebraTest1	0 of 10
	AlgebraTest1.tns	0 of 10
	AlgebraTest2.tns	0 of 10
	AlgebraTest1	6 of 10
	Unprompted-12-01	(1)
	AlgebraTest1.tns	7 of 10
	Plot Differential Equation	0 of 1
	Plot Differential Equation.tns	6 of 10
	Poll 1.tns	4 of 9
	Poll 6.tns	1 of 9
	Poll 5.tns	1 of 9
	ICECreamConeDocument.t...	2 of 10
	02 Functions	0 of 4
	Homework2.tns	0 of 9
	Homework2.tns	0 of 9
	00 Getting Started.tns	0 of 9
	Homework2.tns	0 of 9
	Mixed Files	3 of 3
	Mixed Files	3 of 3
	Poll 4.tns	3 of 11
	Unprompted-11-18	(4)
	10 Simple Machines	0 of 4
	05 Geometry	0 of 1

## Opening a Document from the Portfolio Workspace

To open a document for review from the Portfolio Workspace, follow these steps:

1. Use the Workspace selector to select the Portfolio Workspace.
2. Right-click a column cell or a cell in a student row, and then click **Open in Review workspace**.

Assignment Summary	02 Functions	03 Linear Eqns	Algebra Test2	Average
Column Actions				
Class Average	---	---	0%	0%
Date	12-08	12-08	12-08	
Baker, Susan				
Chopra, Laxmi			0%	0%
Garcia, Rafe			0%	0%
Huang, Shen			0%	0%
Kapur, Samir				
Li, Song				
Lopez, Maria				
Moore, Jacob				
Ortega, Carlos			0%	0%
Simmons, Nadine			0%	0%
Thompson, Olivia				

The software automatically switches to the Review Workspace with the selected document open.

## Viewing Data

You can view data in the Student pane or in the Data View pane. You can choose a student to view their answer, or you can choose an answer to view which students gave that answer.

### Viewing Data from the Student Pane

- ▶ Click a student name in the Student pane to view that answer in the Data View pane. You can select more than one student at a time.

The software highlights the selected student's answer in blue.

The screenshot shows the 'Review Toolbox' interface. On the left is a table with columns for 'Student', 'Response', and 'Time'. The table contains the following data:

Student	Response	Time
<input checked="" type="checkbox"/> Baker, Susan	$\sqrt{5}$	11:50:18
<input checked="" type="checkbox"/> Chopra, Laxmi	0.734	11:50:14
<input checked="" type="checkbox"/> Huang, Shen	$\sqrt{5}$	11:50:36
<input checked="" type="checkbox"/> Kapur, Samir	$\sqrt{5}$	11:50:05
<input checked="" type="checkbox"/> Li, Song	$\sqrt{5}$	11:50:32
<input checked="" type="checkbox"/> Lopez, Maria		
<input checked="" type="checkbox"/> Moore, Jacob	$\sqrt{5}$	11:50:28
<input checked="" type="checkbox"/> Simmons, Nadine		
<input checked="" type="checkbox"/> Thompson, Olivia	$\frac{3}{8}$	11:50:25

On the right is a 'Data View' pane titled 'Which of these is not a rational number?'. It displays a bar chart with five bars. The bars are labeled with the following values and options: 0.734 (1),  $\frac{3}{8}$  (1),  $\sqrt{5}$  (5), 3.33333 (0), and an unlabeled bar (5). The bars for  $\sqrt{5}$  and the unlabeled bar are highlighted in blue.

If you switch between bar chart, table, and graph views, the software retains the selected information and highlights the responses from the selected students.

**Note:** Since student responses can vary for List questions, the software does not show List answers for selected students in the Data View pane.

### Viewing Data from the Data View Pane

- ▶ Click a response in the Data View pane to view the students who gave that response in the Student pane. You can select more than one response at a time.

The software highlights the corresponding student names in blue.



The screenshot shows the Review Toolbox interface. On the left, a table lists student responses:

Student	Response	Time
<input checked="" type="checkbox"/> Baker, Susan	$\sqrt{5}$	11:50:18
<input checked="" type="checkbox"/> Chopra, Laxmi	0.734	11:50:14
<input checked="" type="checkbox"/> Huang, Shen	$\sqrt{5}$	11:50:36
<input checked="" type="checkbox"/> Kapur, Samir	$\sqrt{5}$	11:50:05
<input checked="" type="checkbox"/> Li, Song	$\sqrt{5}$	11:50:32
<input checked="" type="checkbox"/> Lopez, Maria		
<input checked="" type="checkbox"/> Moore, Jacob	$\sqrt{5}$	11:50:28
<input checked="" type="checkbox"/> Simmons, Nadine		
<input checked="" type="checkbox"/> Thompson, Olivia	$\frac{3}{8}$	11:50:25

On the right, a window titled "Which of these is not a rational number?" displays a table view of the responses:

Response	Frequency
0.734	1
$\frac{3}{8}$	1
$\sqrt{5}$	5
3.33333	0

If you switch between bar chart, table, and graph views, the software retains the selected information and highlights the students who answered the selected response.

**Note:** If Multiple Choice questions have multiple responses, a blue area is displayed next to all responses from the selected student.

Response	Frequency
0.734	0
$\frac{3}{8}$	1
$\sqrt{5}$	4
3.33333	3

A red arrow points to the blue vertical bar on the right side of the table, which highlights the selected response ( $\sqrt{5}$ ).

**Note:** For List questions, right-click anywhere in the table view, and then click **Show Student Column** to show student names next to their responses.

Student	list1	list2
Thompson, Olivia	101	333
Thompson, Olivia	201	411
Thompson, Olivia	85	278
Kapur, Samir	444	411
Huang, Shen	101	145
Huang, Shen	201	411
Huang, Shen	85	275
Chopra, Laxmi	101	145

## Changing the Aspect Ratio

The Review Workspace displays graphs in a question application as they appear on the students' handhelds or computers. At times, the graphs may appear stretched, since the graph may have changed the aspect ratio to fit on the handheld.

You can select to view the graphs as they come in from students, or you can preserve the aspect ratio of the graph as it appeared when it was inserted in the question application.

By default, the Review Workspace displays graphs in a question application as they appear when the students submit them.

To preserve the aspect ratio of a graph as it appeared when it was inserted in the question, follow these steps:

1. View the data in graph view.
2. Right-click on the graph in the Data View pane, and then click **Graph Tools > Aspect Ratio**.

— or —

3. Click  in the Review Toolbox and then click **Graph Tools > Aspect Ratio**.

When the Aspect Ratio box is checked, the aspect ratio is preserved. When the box is not checked, the aspect ratio may change.

## Organizing Responses

You can configure a plot list for List questions, organize bar chart data and table views, individualize student responses, and organize Multiple Choice questions that have multiple responses into separate, group, or equivalent responses.

### Configuring a Plot List

The plot list settings let you set different shapes for the different plots to help you follow separate lines or responses on a graph.

To set the plot list settings, follow these steps.

1. While in graph view, click **Graph Tools** in the Review toolbox.

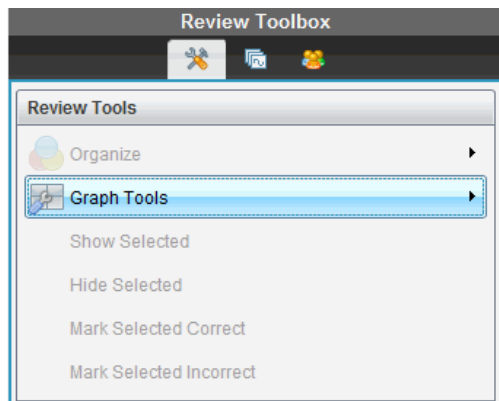

2. Click **Plot List Settings**.

The Configure Plot(s) dialog box opens.

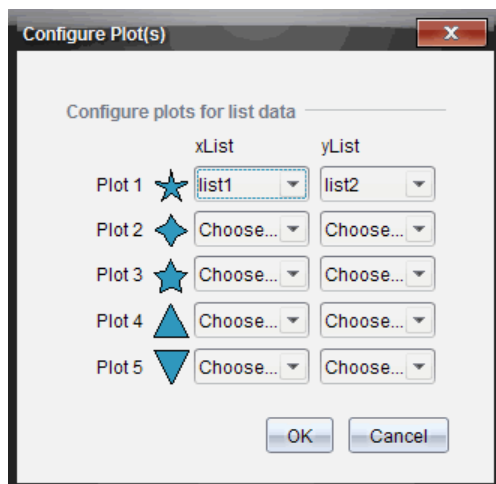

3. Click the down arrow next to a shape to choose which list to represent (list1, list2, and so forth) for the xList and yList.

**Note:** You can choose more than one shape for each list.

4. Click **OK**.

The graph view is updated with the shapes you selected.

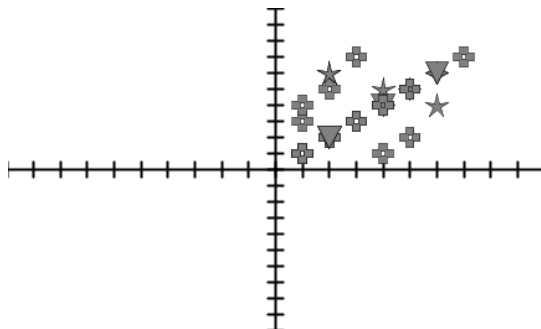

When you change plot list settings in the graph view, and then change to bar chart view, the software asks you to choose which lists to show in the bar chart. You can choose an individual list, or a list for the Category and Frequency.

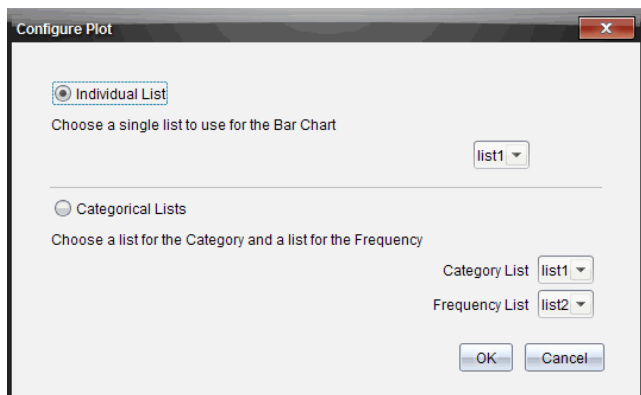

5. Select the applicable options and click **OK**.

If you click **Cancel**, the software shows the bar chart as an individual list, using list1 as the default.

You can configure the plot list at any time while in bar chart view.

**Note:** To configure the plot list from the bar chart view, click **Organize** in the Review toolbox and click **Plot List Settings**.

### Individualizing Student Responses

You can change the colors of each student response in a graph so you can identify the separate responses. This is useful when you are running a live activity; you can view the progress of individual students as they graph functions, move points on a graph, or respond to Quick Poll questions.

- To change the color of student responses, click **Graph Tools** in the Review toolbox, and then click **Individualize Student Responses**.

The responses are displayed in different colors in the Data View pane.

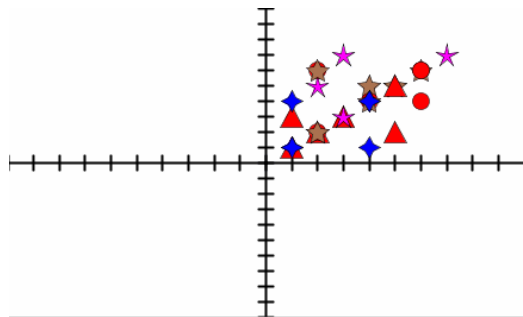

## Organizing List Data

In bar chart view, you can organize list data by Frequency, Numeric Value, or Alphabetically.

To organize list data, follow these steps.

1. In bar chart view, click **Graph Tools**.

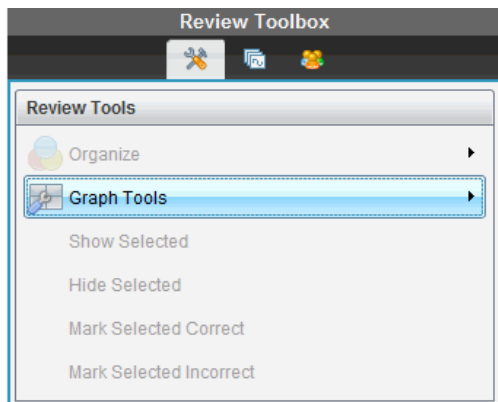

2. Select to sort the bars by Frequency, Numeric Value, or Alphabetically.

The bar chart view is updated in the Data View pane.

## Organizing Bar Chart Data

Organizing by separate responses shows the results for each individual response. For example, all of the A responses, all of the Bs, all of the Cs, and so forth. Organizing by group responses shows all multiple responses from the students. For example, all of the A plus B responses, all of the A plus C responses, and so forth.

Organizing by equivalency combines similar results into one bar. For example,  $y=4-x$ ,  $y=-x+4$ , and  $y=-(x-4)$  would all be combined into one bar or table row.

By default, Multiple Response questions are displayed as separate responses in the bar chart view.

Settings for organizing by separate or group responses and for organizing by equivalency are retained when you close and reopen the Review Workspace.

To organize by grouped responses, follow these steps.

1. Click the Organize tool in the Review toolbox.

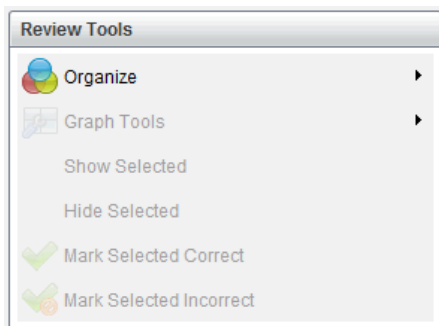

2. Click **Show Student Responses Grouped Together**.

The Data View pane shows the grouped responses.

Which of these is not a rational number? Choose all that apply.

$\sqrt{5}$ , 3.33333	<input type="checkbox"/>	2
$\frac{3}{8}, \sqrt{5}$	<input type="checkbox"/>	1
$\sqrt{5}$	<input type="checkbox"/>	1
3.33333	<input type="checkbox"/>	1

3. To return to the default view, click the Organize tool, and then click **Show Student Responses Separated**.

The Data View pane shows the data as separate responses.

Which of these is not a rational number? Choose all that apply.

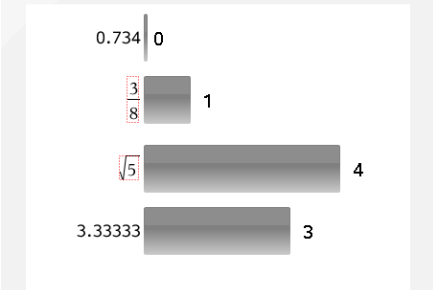

### Organizing by Equivalency

Organizing by equivalency groups all similar responses together in one bar or row. In bar chart view, you can still see separate responses by clicking on the bar.

To organize by equivalency, follow these steps.

1. Click the Organize tool in the Review toolbox.

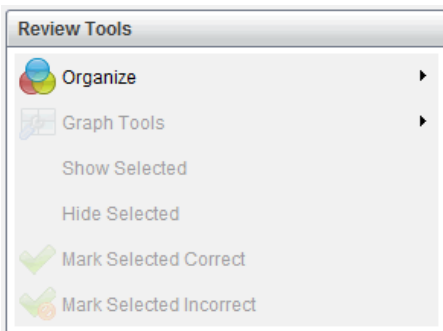

2. Click **Group Responses by Equivalence**.

The Data View pane shows the grouped responses.

3. To return to the default view, click the Organize tool, and then click **Group Responses by Exact Matches**.

The Data View pane shows the data as separate responses.

### Hiding and Showing Responses

You can hide one or more student responses in the Student pane or in the Data View pane. When you hide a response, the corresponding data updates, and the Data View

pane does not show the hidden data. Settings for hiding or showing data are retained when you close and reopen the Review Workspace.

When you hide responses, the following actions occur in the different views.

- **Bar chart view.** The bar chart is updated and re-sorted using the current data.
- **Table view.** The table is updated and re-sorted using the current data.
- **Graph view.** The graph is updated using the current data. Any regression that was added is automatically recalculated and the new values are displayed.
- **Show your work.** The selected student's work is hidden from view.

### Hiding Responses from the Student Pane

To hide responses, follow these steps.

1. In the Student pane, select the students whose responses you want to hide.

The selected student responses are highlighted in blue in the Data View pane.

The screenshot shows the 'Review Toolbox' interface. On the left is a table with columns 'Student' and 'Response'. The 'Student' column has a checkmark icon next to each name. The 'Response' column contains linear equations. The rows for Baker, Susan; Moore, Jacob; and Simmons, Nadine are highlighted in blue. The other rows are in white. On the right is a graph with x and y axes. A text box above the graph says 'Edit the expression to change the slope from positive to negative.' The graph shows three lines: a gray line with a negative slope, and two blue lines with positive slopes.

Student	Response
<input checked="" type="checkbox"/> Baker, Susan	$y = x + 3$
<input checked="" type="checkbox"/> Chopra, Laxmi	$y = 3 - x$
<input checked="" type="checkbox"/> Huang, Shen	$y = 3 - x$
<input checked="" type="checkbox"/> Kapur, Samir	
<input checked="" type="checkbox"/> Li, Song	$y = 3 - x$
<input checked="" type="checkbox"/> Lopez, Maria	
<input checked="" type="checkbox"/> Moore, Jacob	$y = x + 3$
<input checked="" type="checkbox"/> Simmons, Nadine	$y = x - 3$
<input checked="" type="checkbox"/> Thompson, Olivia	

2. Click the Options menu , and then click **Hide Selected**, or clear the check box next to the student name.

The Data View pane hides the responses of the students you selected, and shows the responses of the remaining students.

The student names you selected are displayed in gray text.



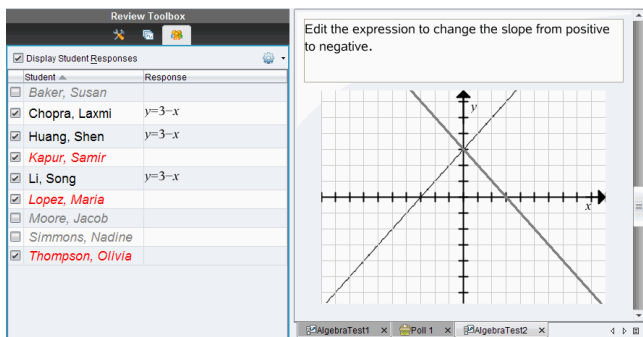

**Note:** If a response is hidden, click a student name to show the response. The response is displayed in blue in the Data View pane. All bar chart, table, and graph views are updated with the selected data. The response stays in view until you select a different student.

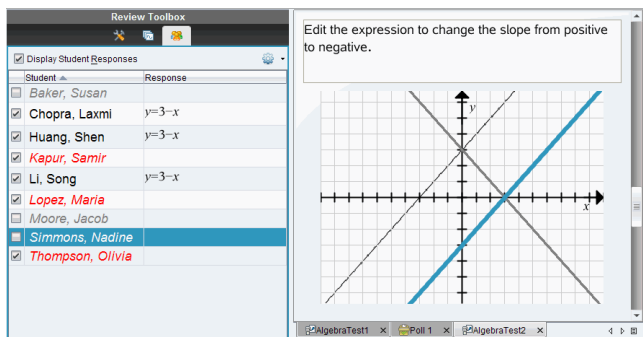

### Hiding Responses from the Data View Pane

You can hide responses in the bar chart, graph, or table views. When you hide responses, the Data View pane updates the data and does not show the hidden responses. In the Student View, student names are displayed in gray. In Page Sorter view, the software does not change the documents or icons.

To hide responses, follow these steps.

1. In the Data View pane, select the responses you want to hide.

The selected students are highlighted in blue in the Student pane.

Student	Response
Baker, Susan	$y = -x + 3$
Chopra, Laxmi	$y = 3 - x$
Huang, Shen	$y = 3 - x$
Kapur, Samir	
Li, Song	$y = 3 - x$
Lopez, Maria	
Moore, Jacob	$y = -x + 3$
Simmons, Nadine	$y = -x - 3$
Thompson, Olivia	

2. Right-click the response and click **Hide Selected**.

The Data View pane hides the responses you selected, and shows the responses of the remaining students.

The student names that correspond with the responses you selected are displayed in gray text.

Student	Response
Baker, Susan	
Chopra, Laxmi	$y = 3 - x$
Huang, Shen	$y = 3 - x$
Kapur, Samir	
Li, Song	$y = 3 - x$
Lopez, Maria	
Moore, Jacob	$y = 3 - x$
Simmons, Nadine	
Thompson, Olivia	

## Showing Responses

To show the hidden responses, follow these steps.

1. In the Student pane, select the students whose responses you want to show.
2. Click the Options menu , and then click **Show Selected**.

The student names are displayed in black and student responses are shown in the Data View pane.

## Marking Responses as Correct or Incorrect

You can use the Review Workspace to mark selected answers as correct or incorrect. If you are reviewing a document with a correct answer already marked, you can change the correct answer. In a Multiple Choice question with multiple responses, you can add additional correct answers.

If the **Show Correct Answer** box is checked, answers marked as correct are highlighted in green.

The software reevaluates the data based on the correct responses, and the Data View pane updates the view to reflect the changes.

To mark a response as correct:

- ▶ In the Student pane, right-click a student and click **Mark as Correct**.
- ▶ In the Data View pane, right-click a response and click **Mark Selected Correct**.
- ▶ In the Data View pane, click a response and click **Mark Selected Correct** in the Review Tools pane.

In Multiple Choice questions with multiple answers, check marks are displayed next to the responses.

- ▶ Click a check mark to mark a response as correct.

When you mark a response as incorrect, the software removes the green highlight.

To mark a response as incorrect:

- ▶ In the Student pane, right-click a student and click **Remove as Correct**.
- ▶ In the Data View pane, right-click a response and click **Mark Selected Incorrect**.
- ▶ In Multiple Choice questions with multiple answers, click the green check mark.

**Note:** If you change an answer to correct or incorrect, any points you already manually awarded students for correct or incorrect answers will not be changed.

When you mark responses, the following actions occur in the different question types.

Question Types	Action
Multiple Choice, Single Response Image: Label, Single Response Image: Point on, Single Response	Adding a new answer replaces the current answer. Removing an answer leaves the question with no correct answers.
Multiple Choice, Multiple Responses Image: Label, Multiple Responses Image: Point on, Multiple Responses	Adding a new answer increases the correct answer set. For example, an answer of "A and B" becomes "A and B and C." Removing an answer decreases the correct answer set.
Open Response: Explanation Open Response: Text Match Equation: $f(x)$ and $y=$ Coordinate Points	Adding a new answer increases the correct answer set. Removing an answer leaves the question with no correct answers.

Question Types	Action
Expression: Variable Chemical	
Expression: Numerical	Adding a new answer, with or without tolerance, replaces the current answer. Removing an answer leaves the question with no correct answers.

The following examples show answers marked as correct in different data views.

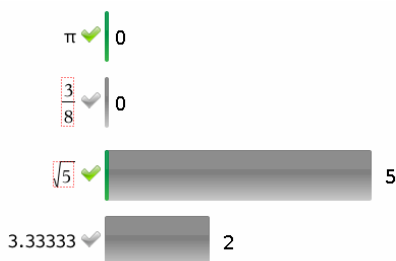

Bar chart view, Multiple Choice question with multiple responses and two correct answers, organized by Show Student Responses Separate, and no student selected in the Student pane.

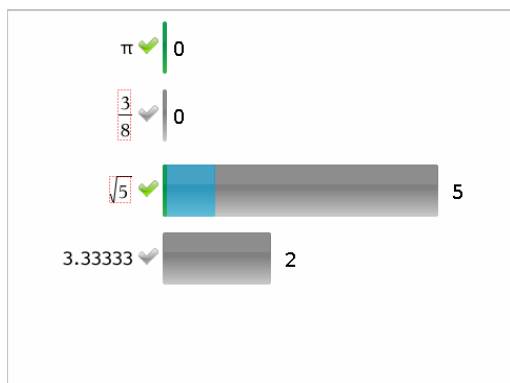

Bar chart view, Multiple Choice question with multiple responses and two correct answers,

organized by Show Student Responses Separate, and one student selected in the Student pane.

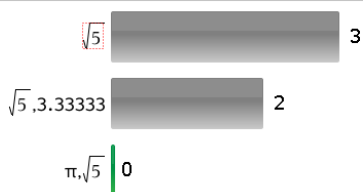

Bar chart view, Multiple Choice question with multiple responses and two correct answers, organized by Show Student Responses Grouped Together, and no students selected in the Student pane.

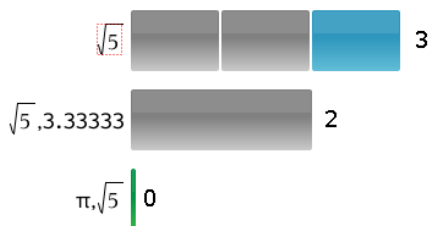

Bar chart view, Multiple Choice question with multiple responses and two correct answers, organized by Show Student Responses Grouped Together, and one student selected in the Student pane.

Response	Frequency
0.734	0
$\frac{3}{8}$	1
$\sqrt{5}$	1
3.33333	2

Frequency table view, Multiple Choice question with one correct answer, and no student selected in the Student pane.

Student	Response
Chopra, Laxmi	$\sqrt{5}$
Garcia, Rafe	3.33333
Ortega, Carlos	3.33333
Simmons, Nadine	$\frac{3}{8}$

Student table view, Multiple Choice question with one correct answer, and one student selected in the Student pane.

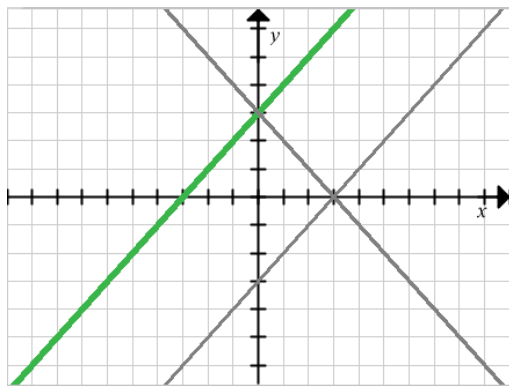

Graph view, Equation  $y=$  question with one correct answer, and no student selected in the Student pane.

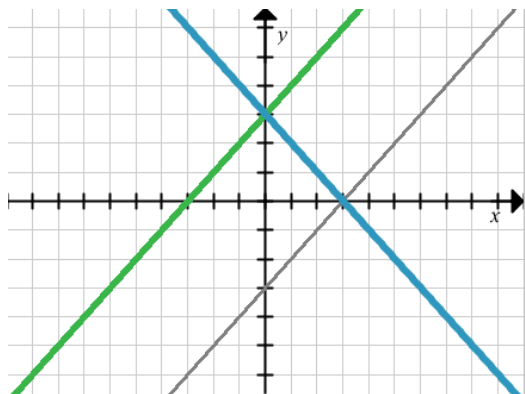

Graph view, Equation  $y=$  question with one correct answer, and one student selected in the Student pane.

### ***Adding Teacher Data***

There may be times you want to add your own data to a graph you are reviewing in class. The Graph Tools allow you to add teacher points and teacher equations to a graph, and to set the plot list settings and individualize student responses.

Teacher data is displayed larger than student data, and in a different color.

When you add teacher data, the software reevaluates the data, and the Data View pane updates the view to reflect the changes.

You can hide and show teacher data, but you cannot mark a teacher response as correct or incorrect.

### **Adding Teacher Points**

1. Click **Graph Tools** in the Review toolbox.

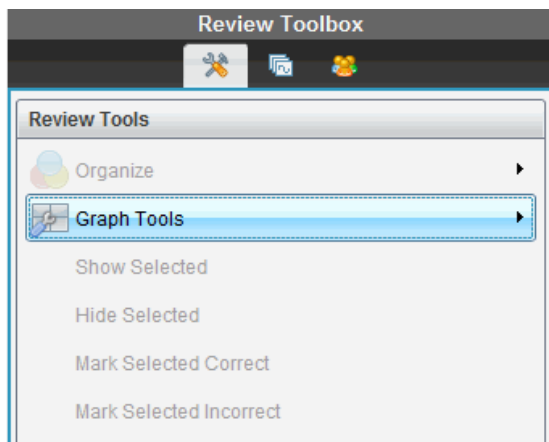

2. Click **Add Teacher Point**.

The Add Teacher Point dialog box opens.

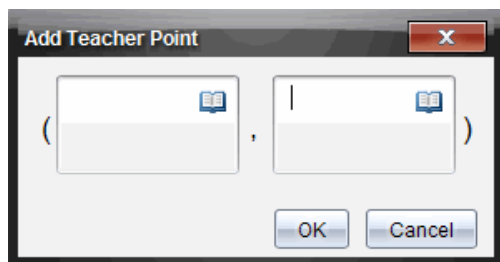

3. Type your information in the fields.

Click  to open math templates and symbols that you can add to the fields.

4. Click **OK**.

Your point is displayed on the graph, and the name **Teacher** is added to the list of names in the Student pane.

**Note:** The teacher may have multiple entries.



Student	Response
<input checked="" type="checkbox"/> Chopra, Laxmi	$y=3-x$
<input checked="" type="checkbox"/> Garcia, Rafe	$y=x-3$
<input checked="" type="checkbox"/> Lopez, Maria	
<input checked="" type="checkbox"/> Moore, Jacob	$y=x+3$
<input checked="" type="checkbox"/> Ortega, Carlos	$y=3-x$
<input checked="" type="checkbox"/> Simmons, Nadine	$y=3-x$
<input checked="" type="checkbox"/> Teacher	(2,3)

Edit the expression to change the slope from positive to negative.

## Adding Teacher Equations

1. Click **Graph Tools** in the Review toolbox.

Review Toolbox

Review Tools

- Organize
- Graph Tools**
- Show Selected
- Hide Selected
- Mark Selected Correct
- Mark Selected Incorrect

2. Click **Add Teacher Equation**.

The Add Teacher Equation dialog box opens.

Add Teacher Equation

Y=

OK Cancel

3. Type your information in the field.

Click  to open math templates and symbols that you can add to the fields.

4. Click **OK**.

Your line is displayed on the graph, and the name **Teacher** is added to the list of names in the Student pane.

**Note:** The teacher may have multiple entries.

### ***Saving to the Portfolio Workspace***

You can save documents that contain questions and Quick Polls to the Portfolio Workspace, where you can review and analyze individual responses, and assign or change a student's grade.

When you save Quick Polls to Portfolio, students can continue to submit answers to the Quick Poll until you stop the poll. The saved Quick Poll in Portfolio automatically updates without you having to save it again.

**Note:** If you opened the file from the Portfolio Workspace, or if you have already saved the file to Portfolio, the software does not ask you for a file name. The software saves the file to the Portfolio Workspace with the existing file name, and updates any grades you had given students. You can go to the Portfolio Workspace and change a grade at any time.

To save a file to the Portfolio Workspace:

1. Click **File > Save to Portfolio**, or click .

The Save to Portfolio dialog box opens. By default, the name of the file is shown in the **Portfolio name** box. If the file is a Quick Poll you have not saved yet, the default name is <Class name, Quick Poll Set#, mm-dd.tns>. For example: Algebra1 - Mrs. Smith, QP Set 2, 10-26.tns.

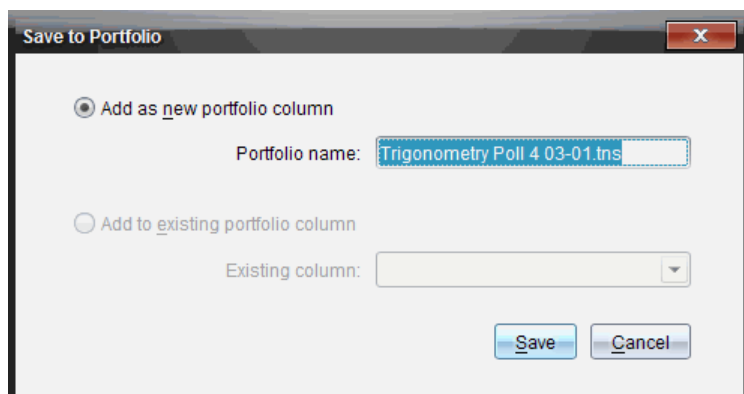

- To add a new Portfolio column, select **Add as new portfolio column**. You can use the existing name or type a new name.
- To add the file to an existing portfolio column, select **Add to existing portfolio column**. Click the down arrow to select the column.

**Note:** Quick Polls cannot be added to existing columns.

2. Click **Save**.

The file is saved in the Portfolio Workspace.

### ***Saving Data as a New Document***

You can take data collected from students, view it in table form, and save it as a Lists & Spreadsheet document. This document can be used as an instructional aid or sent to the students for further analysis.

**Note:** If the data comes from a Lists question, the column titles in the Table View are used as the names for the list variables. If the variable names are not usable, the software renames them. For instance, if the name has a space, the software replaces it with an underscore.

1. To save data to a new Lists & Spreadsheet document, make sure you are viewing the data in table view.
2. Right-click anywhere in the table, and then click **Send Table to New Document**.

**Note:** Hidden data is not sent. If data is sorted, the sort order is retained in the new document.

The Lists & Spreadsheet document opens in the Documents Workspace.

# Using the Portfolio Workspace

Use this workspace to save, review, modify grades, and manage class assignments from students.

The screenshot shows the 'Assignments' workspace. On the left is the 'Assignments Summary' pane (labeled 1) with a tree view of assignments: AlgebraReview for Algebra, Algebra 101 - MGentry, QP Set 1, 11-18.tns, DeterminingArea, Algebra 101 - MGentry, QP Set 1, 11-16.tns, Algebra 101 - MGentry, QP Set 1, 11-02.tns, and Getting Started 3\_0. On the right is the 'Assignment Summary' table (labeled 2) with columns for Date and scores for each assignment. The table includes a 'Class Average' row and a 'Mean Score' column.

Column Actions	AlgebraReview for Algebra	Algebra 101 - MGentry, QP Set 1, 11-18.tns	DeterminingArea	Algebra 101 - MGentry, QP Set 1, 11-16.tns	Algebra 101 - MGentry, QP Set 1, 11-02.tns	Getting Started 3_0	Mean Score
Class Average	97%	97%	96%	96%	96%	96%	
Date	11-18	11-18	11-16	11-02	11-02		
Susan Baker	100%	100%	100%	100%	100%	100%	
Song Li	80%	80%	100%	100%	90%	90%	
Shen Huang	100%	100%	100%	100%	100%	100%	
Samir Kapur	100%	100%	80%	80%	90%	90%	
Rafe Garcia	100%	100%	100%	100%	100%	100%	
Olivia Thompson	95%	95%	100%	100%	96%	96%	
Nadine Simmons	100%	100%	85%	85%	92%	92%	
Maria Lopez	95%	95%	100%	100%	98%	98%	
Laxmi Chopra	100%	100%	100%	100%	100%	100%	
Isaiah Moore							

- 1 Assignments pane.** Select assignments to view student information and scores. You can redistribute, rename, or remove an assignment.
- 2 Work area.** Lists the students in the selected class and shows the scores received for each assignment. Enables you to view class or student assignments; sort by assignment, score, or student; and edit assignment scores.

## Exploring the Assignments Pane

The screenshot shows the 'Assignments' pane (labeled 3) with a tree view of assignments. The 'Assignments Summary' (labeled 1) is expanded, showing a list of assignments (labeled 2): AlgebraReview for Algebra, Algebra 101 - MGentry, QP Set 1, 11-18.tns, DeterminingArea, Algebra 101 - MGentry, QP Set 1, 11-16.tns, Algebra 101 - MGentry, QP Set 1, 11-02.tns, and Getting Started 3\_0.

- 1 Assignments Summary.** Lists the names of the assignments that you saved to the Portfolio Workspace. Shows a class and student average in the workspace.
  - Click the minus sign (-) to collapse the list of individual assignments and view only the Assignments Summary.
  - Click the plus sign (+) to show the list of individual assignments.
- 2 Individual assignments.** Click an assignment to see the student scores for that assignment.

- ③ **Options menu.** Available when you select an individual assignment. Click  to open a menu that allows you to:
- Open the document in the Review Workspace.
  - Redistribute the assignment to the current class.
  - Remove the assignment from the Portfolio Workspace. The assignment still exists in other workspaces.
  - Rename the assignment.

## Exploring the Workspace Views



The appearance of the workspace changes depending on what you selected in the Assignments pane.

### Assignments Summary View

This work area opens when you select **Assignments Summary** in the Assignments pane.

Assignment Summary ▾		Algebra 101 - ...	Algebra 101 - ...	DeterminingAR...	Algebra 101 - ...	Algebra 101 - ...	Getting Started ...	Mean Scr
①	Column Actions							
②	Class Average	---	97%	---	---	96%	---	96%
③	Date	11-18	11-18	11-18	11-16	11-02	11-02	
	Susan Baker		100%			100%		100%
	Song Li		80%			100%		90%
	Shen Huang		100%			100%		100%
	Samir Kapur		100%			80%		90%
④	Rafe Garcia		100%			100%		100%
	Olivia Thompson		95%			100%		98%
	Nadine Simmons		100%			85%		92%
	Maria Lopez		95%			100%		98%
	Laxmi Chopra		100%			100%		100%
	Jacob Moore							

- ① **Column Actions.** Lets you perform certain actions on a column. Click a file icon anywhere in this row to:
- Open an assessment for review in the Review Workspace.
  - Sort assignments in ascending or descending order by student.
  - Open the Master in the Review Workspace.
  - Remove from Portfolio.
  - Rename the assignment.
- ② **Class Average.** Shows the average score of the class for the assignment in that column.
- ③ **Date.** Shows the date the file was collected. The date the last file was collected is shown in the first column on the left.
- ④ **Students.** Lists all students in the class.

- 5 **Column Header.** Shows the name of the assignment saved to the Portfolio Workspace. You can perform the same actions on the column header as you can on the column actions. Right-click the column header to open the menu. The column header **Mean Score** shows the mean score for all assignments and the mean score for all assignments per student. Right-click the **Mean Score** column to sort by ascending or descending scores.
- 6 **File icon.** Shows the type of file. The file types shown are:
-  Quick Poll
  -  TI-Nspire™ file
- 7 **Student scores.** If questions are automatically graded, the scores are shown. You can change a student's score for an assignment.

### Individual Assignment View

This work area opens when you select a single assignment in the Assignments pane. To view this work area, the assignment you select must be a .tns file that contains one or more questions.

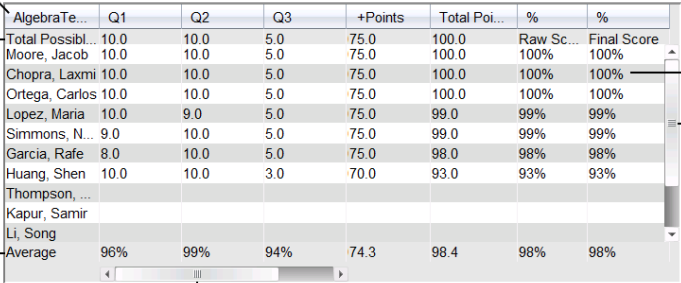

AlgebraTe...	Q1	Q2	Q3	+Points	Total Poi...	%	%
Total Possibl...	10.0	10.0	5.0	75.0	100.0	Raw Sc...	Final Score
Moore, Jacob	10.0	10.0	5.0	75.0	100.0	100%	100%
Chopra, Laxmi	10.0	10.0	5.0	75.0	100.0	100%	100%
Ortega, Carlos	10.0	10.0	5.0	75.0	100.0	100%	100%
Lopez, Maria	10.0	9.0	5.0	75.0	99.0	99%	99%
Simmons, N...	9.0	10.0	5.0	75.0	99.0	99%	99%
Garcia, Rafe	8.0	10.0	5.0	75.0	98.0	98%	98%
Huang, Shen	10.0	10.0	3.0	70.0	93.0	93%	93%
Thompson, ...							
Kapur, Samir							
Li, Song							
Average	96%	99%	94%	74.3	98.4	98%	98%

- 1 Name of the selected assignment.
- 2 **Total Possible.** This row shows the points for these categories:
- Total possible points for each question in the assignment. You can edit this number.
  - Total number of extra points possible for the assignment. You can edit this number.
  - Total points for the assignment.
  - Raw score based on the number of points the student received divided by total possible points.
  - Final percentage. This number updates when you edit possible points or extra points. You can edit this score. The final score is

the same as the raw score, unless you change it.

If you edit the final score, it no longer updates if the other points change.

- ③ **Student names.** All students who received the selected assignment. Right-click to open and edit the document in the Documents Workspace, or to open the document for review in the Review Workspace.
- ④ **Average.** Shows the average score for all students, as well as average total points, raw score, and final score.
- ⑤ **Questions in the assignment.** If the document contained multiple questions, each question is displayed here, along with the total possible score for that question.
- ⑥ **Scores.** Lists the score each student received for the selected assignment. Each page in an assignment may have a separate score. Right-click to edit the score, open the assignment in the Documents Workspace, or open the document in the Review Workspace.
- ⑦ **Scroll bar.** Appears when there are more questions in the assignment to view, or more students to view.

## ***Saving an Item to the Portfolio Workspace***



If you are using the TI-Nspire™ software for the first time, the Portfolio Workspace may be empty. You need to save files to the Portfolio Workspace to view and edit scores, and perform other work on the files.

You can save collected, unprompted, and Quick Poll files to the Portfolio Workspace. You can save to the Portfolio Workspace from the Class and Review Workspaces.

When you save Quick Polls to Portfolio, students can continue to submit answers to the Quick Poll until you stop the poll. The saved Quick Poll automatically updates without you having to save it again.

**Note:** If you opened the file from the Portfolio Workspace, or if you have already saved the file to the Portfolio Workspace, the software does not ask you for a file name. The software saves the file to the Portfolio Workspace with the existing file name, and updates any grades you had given students. You can change a grade in the Portfolio Workspace at any time.

To save a file to the Portfolio Workspace, follow these steps.

1. Select the files you want to save.
  - From the Class Record in the Class Workspace, click , and then click **Save selected to Portfolio**.
  - From an open file in the Review Workspace, click **File > Save to Portfolio**, or click .

The **Save to Portfolio** dialog box opens.

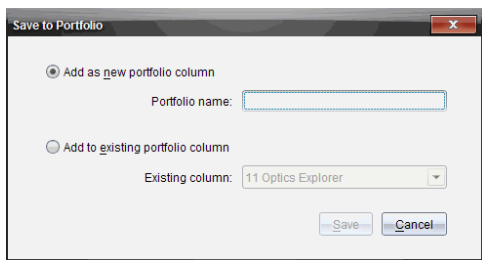

2. Save the files to a new Portfolio column or add them to an existing Portfolio column.
  - To add the files to a new Portfolio column, select **Add as new portfolio column**. You can use the existing name, or type a new name.
  - To save the files to an existing Portfolio column, select **Add to existing portfolio column**. Click the down arrow to select the desired column from the drop-down list.

**Note:** Quick Polls cannot be added to existing columns.

3. Click **Save**.

The file is saved in the Portfolio Workspace.

**Note:** The files you saved in the Portfolio Workspace remain in the Class Record until you remove them using the Remove command.

If a file is deleted from the Class Record, that delete action does not affect the file copy in the Portfolio Workspace. The copy remains in the Portfolio Workspace until it is deleted.

## ***Importing an Item to the Portfolio Workspace***

You can import a .tns file from your computer to a student's Portfolio entry.

1. Click **Assignments Summary**.
2. Highlight a cell in the student row where you want to import the file.

**Note:** You can import a file for only one student at a time.

3. Click **File > Import Item**.

The Open dialog box is displayed.

4. Navigate to the file you want to import and click it.
5. Click **Import**.

If a file already exists in that cell, you are prompted to confirm the file replacement.

- Click **Replace** to save your imported file over the existing file.
- Click **Keep Existing** to keep the existing file and cancel the import file function.



## Editing Scores

There may be times when you want to edit a student's score. For example, an Open Response assignment contains a question that requires the word "Autumn" as the correct answer. One student has entered "Fall." If you want to give the student full or partial credit, you can do so by changing the student's score for the question.

In addition to editing an individual student score, you can edit the total possible points for each question, the extra points, and the final percentage.

- ▶ Use whole numbers to edit the scores. For example, type 75 to give a score of 75%, type 100 to give a score of 100%, and so forth.

**Note:** If you type a score and do not press **Enter**, the change is not made, and the previous score remains in place.

### Previewing a Student's Answer

You can preview a student's answer to an individual assignment question in the Preview Pane. This provides a quick, easy, and efficient method for the review of questions, answers, and the modification of scores.

**Note:** The assignment must contain at least one question to be previewed.

1. Click an individual assignment in the Assignments Summary list.
2. Select the question cell you want to preview.

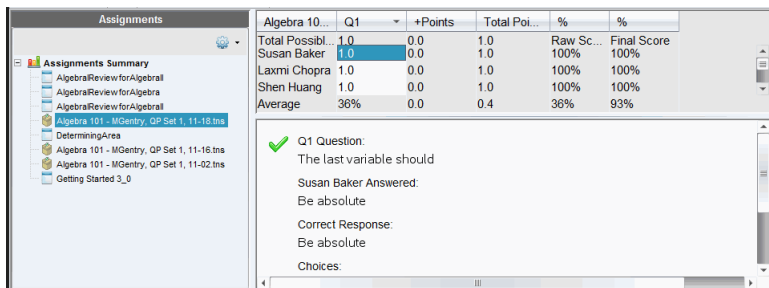

The screenshot shows the 'Assignments Summary' interface. On the left is a tree view of assignments, with 'Algebra 101 - M.Gentry, QP Set 1, 11-18.tns' selected. The main area displays a table of scores for this assignment:

Algebra 10...	Q1	+Points	Total Poi...	%	%
Total Possibl...	1.0	0.0	1.0	Raw Sc...	Final Score
Susan Baker	1.0	0.0	1.0	100%	100%
Laxmi Chopra	1.0	0.0	1.0	100%	100%
Shen Huang	1.0	0.0	1.0	100%	100%
Average	36%	0.0	0.4	36%	93%

Below the table, the 'Preview Pane' shows a question with a green checkmark icon:

Q1 Question:  
The last variable should  
Susan Baker Answered:  
Ee absolute  
Correct Response:  
Ee absolute  
Choices:

The following information is shown in the Preview Pane.

- **Q#Question.** Original question with icon showing q# or incorrect response
- **Student's Answer.** Student's response
- **Correct Response.** Teacher's correct response (blank if there is no correct response)

**Note:** Depending on the question posted, additional information may be displayed.

### Modifying a Student's Score for an Assignment

You can edit the score for an assignment from the Assignments Summary view, or you can edit the score for individual questions in an assignment from the Individual Assignments view. These steps describe how to change a score from either view.

1. In the student row, select the score you want to edit.
2. Right-click the cell and click **Edit Score**.
3. Type the replacement score, and press **Enter**. To cancel, press **Esc**.

### Changing the Total Possible Points for a Question

You can edit the total possible score for individual questions or extra points.

1. Select a cell in the Total Possible row.
2. Right-click the cell and click **Edit Score**.
3. Type the points for the question or for extra points, and press **Enter**.

The software asks if you want to keep the student scores for the question, or reassess the scores for each student. The default setting is to reassess the scores for each student.

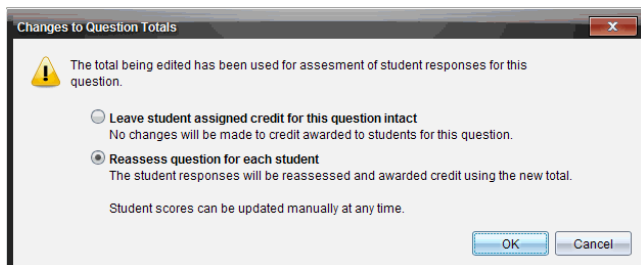

- To keep the student scores without making changes, select **Leave student assigned credit for this question intact**.
  - To reassess the score for each student, select **Reassess question for each student**.
4. Click **OK**.

### Changing the Final Percentage Score

1. In the Individual Assignments view, select the student whose score you want to edit.
2. Right-click the cell in the Final column, and click **Edit Score**.
3. Type the replacement score and press **Enter**. To cancel, press **Esc**.

**Note:** If you edit the final score, it retains the edited value and no longer updates if you edit other values in the row.

## Exporting Results

If you or your school district use electronic gradebook software and reporting, you may want to export scores to these programs. You can export scores from Portfolio Workspace as a .csv formatted file. The export action includes all scores for all students on the selected assignment, or for all assignments.

The .csv file contains all the columns and rows in the workspace except for the Column Actions row. If a student had an empty cell with no score, the .cvs file displays a cell that is empty.

### Exporting the Current View

This allows you to export all data shown in the Portfolio Workspace for a single assignment.

1. Choose an assignment from the list.
2. Click **File > Export Data** click .
3. Select **Export Current View**.

The Export Data dialog box opens.

- The default location is the My Documents folder.
- The default name is the name of the assignment.

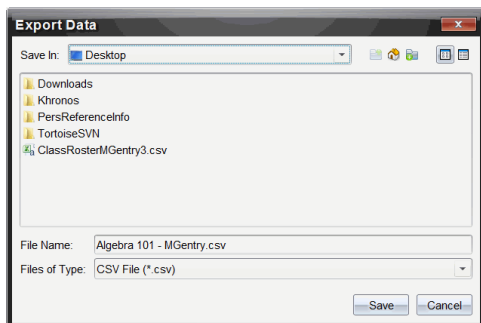

4. Navigate to the location where you want to save the file.
5. Click **Save**.

### Customizing an Export

Custom Export allows you to export the final scores for one or more assignments. This is useful for reporting scores over a date range with only the student name and final score exporting.

1. Click **File > Export Data** or click .
2. Select **Custom Export**.

The Custom Export dialog box opens.

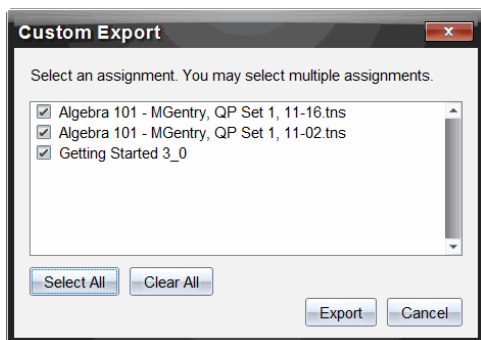

3. Choose the assignments you want to export.
  - Select the check box by assignment name.
  - Click **Select All** to select all assignments.
  - Click **Clear All** to clear selections.
4. Click **Export**.

The Export Data dialog box opens.

- The default location is the My Documents folder.
  - The default name is the name of the assignment.
5. Navigate to the location where you want to save the file.
  6. Click **Save**.

### ***Sorting Information in the Portfolio Workspace***

1. Click the column header of the list you want to sort.

The selected list can be sorted in ascending, descending, or student name order.

2. Click the column header again to sort in another order.

### ***Opening a Portfolio Item in Another Workspace***

You can open a .tns file in the Documents Workspace to edit it; or you can open a .tns or Quick Poll file in the Review Workspace to view student responses in bar chart, table, or graph views.

#### **Opening an Item in the Documents Workspace**

1. Click the file you want to open.

To open a file for all students:

- From the Assignments Summary list, click the file.
- From the Assignments Summary view, click the icon in the Column Actions row, or click the Column Header.

To open a file for selected students:

- From the Assignments Summary view, select a cell in a selected student's row. You can open more than one file in a column, but you cannot open multiple files from different columns.
- From the Individual Assignments view, select a cell in the selected student's row.

2. Click **File > Open for Editing** or right-click and click **Open for Editing**.

The file opens in the Documents Workspace.

### **Opening an Item in the Review Workspace**

1. Click the file you want to open using one of these methods:

- From the Assignments Summary list, select the file.
- From the Assignments Summary view, click the icon in the Column Actions row, or click the Column Header.
- From the Assignments Summary view, click a cell in a selected student's row. You can open more than one file in a column, but you cannot open multiple files from different columns.
- From the Individual Assignments view, click a cell in the selected student's row.

**Note:** Any method you choose in the Review Workspace opens the file with all student responses. You cannot open a file for just one student. However, you can select review responses for an individual student in the Review Workspace.

2. Click **File > Open in Review Workspace** or right-click and click **Open in Review Workspace**.

The file opens in the Review Workspace.

### **Opening a Master Document**

A Master Document is the original document that was sent to students, and it contains the answer key for evaluating the responses collected from students. When you save a document to a column in the Portfolio Workspace, there is usually a Master Document associated with that file.

You can open the Master Document from the Portfolio Workspace in the Assignments Summary view. When you open the Master Document, it opens in the Documents Workspace as a read-only file.

1. In the Column Actions row, click the icon corresponding to the file you want to open.
2. Right-click the icon and click **Open Master Document**.

The document opens in the Documents Workspace as a read-only file.

### **Adding a Master Document**

There may be times when you want to replace an existing Master Document, or add a Master Document to an assignment that does not have one. For example, a question was marked with an incorrect answer and students did not receive credit for that

answer. You can give students credit by changing the answer to that question, and retain the Master Document as a permanent record of the correct answer key.

**Note:** You can add or replace a Master Document for a .tns file, but not for a Quick Poll file.

The new Master Document is used to evaluate student scores. The evaluation works as follows:

- If a question changed, student answers are evaluated for the new question.
- If the new Master Document has questions that were not in the old Master Document, those questions are evaluated. Students may receive zero credit for those questions if they have not seen them.

To add or replace a Master Document, follow these steps:

1. In the Column Actions row, click the icon corresponding to the .tns file you want to open.
2. Click **File > Add Master Document**.

A dialog box opens where you can select a file.

3. Navigate to the .tns file you want to use as the new Master Document and click **Open**.

The software displays a message warning that replacing the Master Document will cause the software to reevaluate the student scores.

4. Click **Add/Replace Master** to assign the new Master Document, or click **Cancel** to cancel the action.

## ***Redistributing a Portfolio Item***

Redistributing a file to the class is a useful way to return graded assignments or to return assignments for additional work. Class must be in session to redistribute a file.

**Note:** You cannot redistribute a Quick Poll file.

1. Right-click the item you want to redistribute.
2. Click **Redistribute to Class**, or click .

The system sends the file to each student logged onto the TI-Nspire™ Navigator™ network.

## ***Collecting Missing Files from Students***

There may be times when you store a set of student files to the Portfolio Workspace and the collection is incomplete because not all students were present, had the file ready for collection, or were not logged on. Class must be in session to collect a file.

1. Select an individual file, or click a file icon on the Column Actions row to select all files in that column.

**Note:** You can collect only one column of files at a time.

## 2. Click **Collect Missing**.

Missing files are collected from those students who are logged in to the network and whose files were not initially collected.

### ***Sending Missing Files to Students***

There may be times when you send a set of files to students and the send is incomplete because not all students were present, or logged on, or a new student was added to the class. Class must be in session to send a missing file.

1. Select an individual file, or click a file icon on the Column Actions row to select all files in that column.

**Note:** You can only send files contained in one column at a time.

## 2. Click **Send Missing**.

Missing files are sent to those students who are logged in to the network and who did not initially receive the files.

### ***Renaming a Portfolio Item***

You can rename an assignment from the Assignments pane or from the column header.

1. Click the assignment name or column header you want to rename.
2. Right-click and click **Rename**.

The Rename Portfolio Column dialog box opens.

3. Type the new name.
4. Click **Rename**. Click **Cancel** to cancel the request.

The column appears in the column header and in the Assignments pane with the new name.

### ***Removing Columns from Portfolio***

There may be times you want to delete files from Portfolio. For example, an incorrect file was sent to or collected from a class. You can remove an assignment from the Assignments pane or from the column header.

1. Click the assignment name or column header you want to remove.
2. Right-click and click **Remove From Portfolio**.

The Remove from Portfolio dialog box opens.

3. Click **Remove** to delete the file. Click **Cancel** to cancel the request.

**Note:** If a file is saved to the Portfolio Workspace and later deleted from the Class Record, that delete action does not affect the file copy in the Portfolio. The copy remains in the Portfolio Workspace until it is deleted.

## Removing Individual Files from Portfolio

There may be times you want to delete a single file or a few files from a column list, but not all of the files. For example, an incorrect file was collected from a student. Remove individual files from the work area in the Assignments Summary view.

1. Click the file or files within a single column that you want to delete.
2. Press **Delete**.

The Remove Selected Document(s) dialog box opens.

3. Click **Remove** to delete the files. Click **Don't Remove** to cancel the request.

## Summary of File Type Options

	.tns	.tns with questions	Quick Poll	Other file types
Save to Portfolio	✓	✓	✓	✓
Save Selected to Portfolio	✓	✓	✓	✓
Edit Score	✓	✓	✓	✓
Open in Review Workspace		✓	✓	
Open for Editing	✓	✓		✓*
Redistribute to class	✓	✓		✓
Open Master Document	✓	✓	✓	✓
Add Master Document	✓	✓		
Export Data	✓**	✓**	✓**	✓**
Send/Collect Missing	✓	✓		✓
Rename Portfolio Column of files	✓	✓	✓	✓
Remove Portfolio Column of Files	✓	✓	✓	✓
✓*	The file opens in the program the operating system has associated with the file type.			



✓\*\*

Empty, non-graded, and “Other file types” show “No score” in the cell when exported.

# Widgets

All work that you create and save using TI-Nspire™ applications is stored as a document, which you can share with others using TI-Nspire™ software, a TI-Nspire™ CX II handheld, or the TI-Nspire™ App for iPad®. You save these TI-Nspire™ documents as .tns files.

A Widget is a .tns document that is stored in your MyWidgets folder.

You can use Widgets to:

- Easily access text files
- Insert and run scripts (such as the pre-loaded widget example: Stopwatch.tns)
- Quickly insert a saved problem into a document

When you add a Widget, TI-Inspire™ CX extracts only the first page of the selected .tns file, and inserts it into your open document.

## ***Creating a Widget***

A document is regarded as a Widget when it is saved or copied to the designated MyWidgets folder. The default location is:

- Windows®: My Documents\TI-Nspire\MyWidgets.
- Mac®: Documents/TI-Nspire/MyWidgets.
- Handheld: MyWidgets
- TI-Nspire™ App for iPad® and TI-Nspire™ CAS App for iPad®: MyWidgets

If the MyWidget folder has been inadvertently deleted, you must create it before attempting to use a Widget.

**Note:** When you add a Widget, TI-Inspire™ CX extracts only the first page of the selected .tns file, and inserts it into your open document.

## ***Adding a Widget***

### **Adding a Widget to a New Document**

1. Open a new document.

2. Click **Add Widget**.

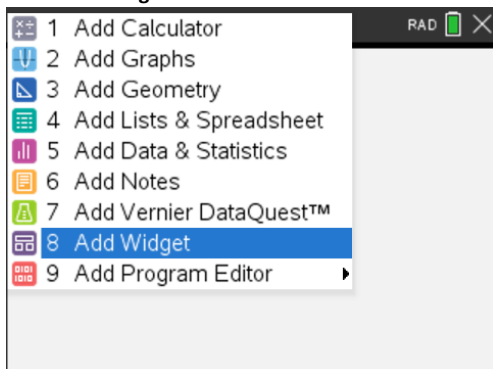

3. Scroll to select a .tns file from the box.

4. Click **Add**.

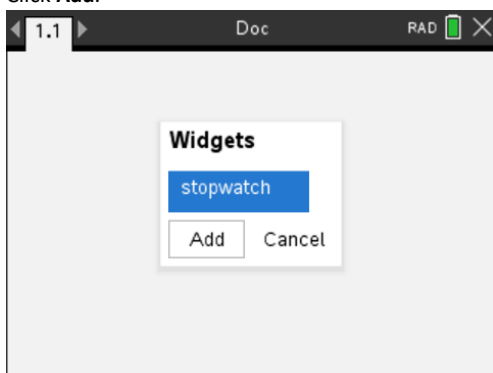

**Note:** Stopwatch is a preloaded .tns file. Any saved .tns file will show up in this list.

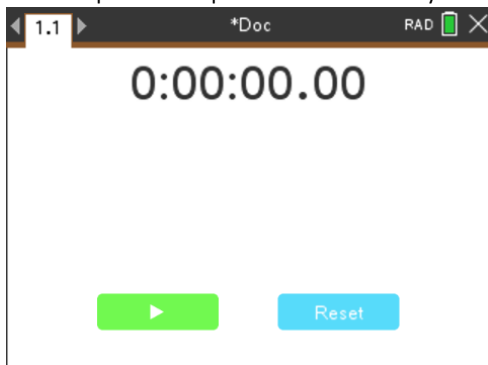

## Adding a Widget to an Existing Document

1. Click **Doc > Insert > Widget**.

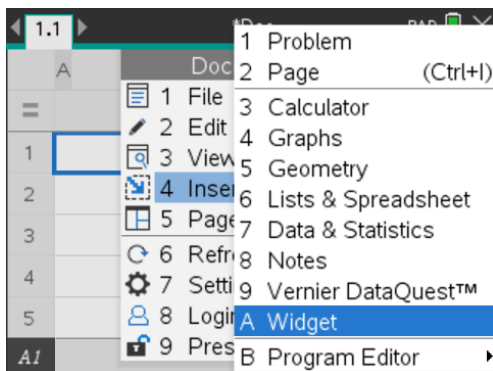

2. Click **Add**.

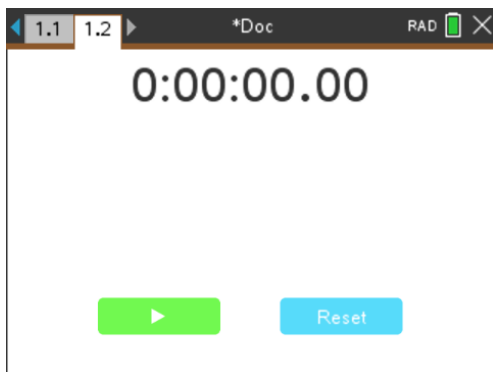
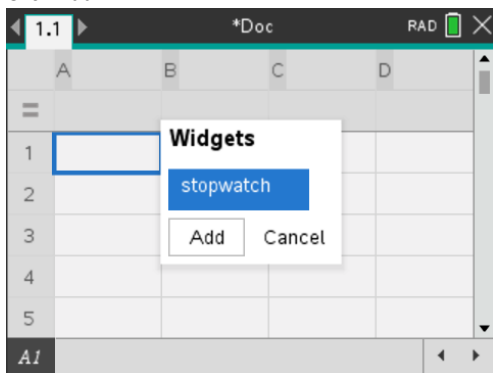

**Note:** You can also add a Widget to a new or existing document using the **Insert** menu.

## Saving a Widget

1. Click .
2. Navigate to MyDocuments > MyWidgets.
3. Type in a name for your Widget.

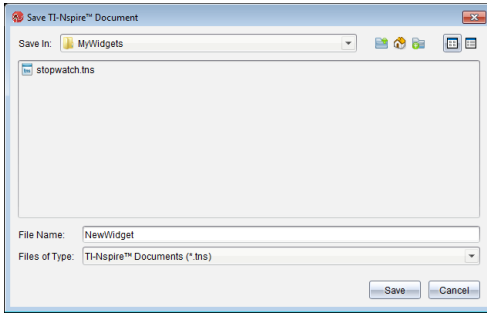

4. Click **Save**.

## Libraries

A library is a TI-Nspire™ document that contains a collection of variables, functions, and/or programs that have been defined as library objects.

Unlike ordinary variables, functions, and programs, which can be used only within a single problem (the problem in which they are defined), library objects are accessible from any document. You can even create public library objects that appear in the TI-Nspire™ Catalog.

For example, suppose you have created library document **matrix** containing public library function **diagwithtrace()** and a private library function **errmsg()**.

Function **diagwithtrace()** displays the diagonal of a square matrix and calculates the trace of the matrix. If its input is not a square matrix, the function calls **errmsg()**, which should then return an appropriate error string.

```
Define LibPub diagwithtrace(m)=  
Func  
© diagwithtrace(mat): diagonal with trace  
If rowDim(m)≠colDim(m) Then  
    Return errmsg("not_square")  
Else  
    Disp diag(m)  
    Return trace(m)  
EndIf  
Define LibPriv errmsg(msgcode)=  
Func  
© Private library function errmsg(msgcode)  
...  
If msgcode="not_square" Then  
    Return "Error: matrix is not square"  
EndIf  
...  
EndFunc
```

You could then use the following syntax to display the diagonal and calculate the trace of matrix *m* defined in the current problem:

```
matrix\diagwithtrace(m)
```

### ***Creating Libraries and Library Objects***

A document is regarded as a library when it is saved or copied to the designated library folder. The default location is:

- Windows®: My Documents\TI-Nspire\MyLib.
- Mac®: Documents/TI-Nspire/MyLib.
- Handheld: MyLib

If the folder has been inadvertently deleted, you must create it before attempting to use libraries.

You can define library objects using either the Program Editor or the Calculator application. Library objects must be defined with a **Define** command and must reside in the first problem of a library document.

**Note:** If you use the Program Editor to define a library function or program, you must store the object and also save the document. Saving the document does not automatically store the object. For more information, see *Programming*.

Naming restrictions apply to library documents and library objects.

- A library document name must be a valid variable name between 1 and 16 characters long, and it must not contain a period or begin with an underscore.
- A library object name must be a valid variable name between 1 and 15 characters long. It must not contain a period and must not begin with an underscore.

## ***Private and Public Library Objects***

When you define a library object, you designate it as private (LibPriv) or public (LibPub).

**Define a=5**

*a* is not a library object.

**Define LibPriv b={1,2,3}**

*b* is a private library object.

**Define LibPub func1(x)=x^2 - 1**

*func1* is a public library object.

A **Private** library object does not appear in the Catalog, but you can access it by typing its name. Private objects serve well as building blocks that perform basic, low-level tasks. Typically, private library objects are called upon by the public functions and programs.



A **Public** library object appears in the Catalog's library tab after you refresh the libraries. You can access a public library object through the Catalog or by typing its name.

Mac® only: In version 1.4 of the software, a library document name cannot contain extended characters, such as Ö, á, or ñ.

**Note:** In library programs and functions defined as public, a comment line (©) immediately following the **Prgm** or **Func** line is automatically displayed as help in the Catalog. You could, for example, show a syntax reminder there.

### **Using Short and Long Names**

Anytime you are in the same problem where an object is defined, you can access it by entering its short name (the name given in the object's **Define** command). This is the case for all defined objects, including private, public, and non-library objects.

You can access a library object from any document by typing the object's long name. A long name consists of the name of the object's library document followed by a backslash "\" followed by the name of the object. For example, the long name of the object defined as **func1** in the library document **lib1** is **lib1\func1**. To type the "\" character on the handheld, press  .

**Note:** If you cannot remember the exact name or the order of arguments required for a private library object, you can open the library document or use the Program Editor to view the object. You also can use **getVarInfo** to view a list of objects in a library.

## Using Library Objects



Before using a library variable, function, or program, make sure that these steps have been followed:

- The object has been defined with the **Define** command, and the command specifies either the LibPriv or LibPub attribute.
- The object resides in the first problem of a library document. The document must reside in the designated library folder and must meet the naming requirements.
- If you defined the object using the Program Editor, it has been stored using **Check Syntax & Store** from the Program Editor menu.
- The libraries have been refreshed.

### Refreshing the Libraries

► Refresh libraries to make the library objects available to your documents.

- From the **Tools** menu, click **Refresh Libraries**.

Handheld: Press   and click **Refresh Libraries**.

### Using a Public Library Object

1. Refresh the libraries.
2. Open the TI-Nspire™ application in which you want to use the variable, function or program.

**Note:** All applications can evaluate functions, but only the Calculator and Notes applications can run programs.

3. Open the Catalog and use the library tab to find and insert the object.
4. If arguments are required, type them inside the parentheses.

### Using a Private Library Object

1. Refresh the libraries.
2. Open the TI-Nspire™ application in which you want to use the variable, function, or program.

**Note:** All applications can evaluate functions, but only the Calculator and Notes applications can run programs.

3. Type the name of the object, such as `lib1\func1()`.

In case of a function or program, always follow the name with parentheses. To type the “\” character on the handheld, press  .

4. If arguments are required, type them inside the parentheses.



## Creating Shortcuts to Library Objects

You can make the objects in a library more easily accessible by using **libShortcut()** to create shortcuts to them. This creates a variable group in the current problem that contains references to all the objects in the specified library document. You can choose to include or exclude the private library objects.

For example, suppose the library document `linalg` contains functions named `clearmat`, `cofactor`, `gausstep`, `help`, `inversestep`, `kernelbasis`, `rank`, and `simultstep`. Executing **libShortcut("linalg", "la")** would create a variable group containing the following members:

```
la.clearmat
la.cofactor
la.gausstep
la.help
la.inversestep
la.kernelbasis
la.rank
la.simultstep
```

You can refer to those library objects from within the current problem by typing their variable names or by selecting them from the Variables menu.

For more details about using **libShortcut()**, see the *Reference Guide*.

## Included Libraries

To help you get started with libraries, the TI-Nspire™ Software installation includes a library document with useful Linear Algebra functions. The library is named **linalg** or **linalgCAS** and is installed in the designated library folder.

**Note:** Updating the handheld's operating system or reinstalling the computer software places all included libraries in the default folder. If you have edited an object in an included library or replaced an included library with your own document of the same name, updating or reinstalling will overwrite your changes. This could also happen after batteries are replaced or the handheld system is reset.

## Restoring an Included Library

If you inadvertently delete or overwrite an included library, you can restore it from the installation DVD.

1. Open the DVD, and navigate to the **libs** folder.
2. Identify the library file to restore, such as **linalg.tns** or **linalgCAS.tns** for the linear algebra library.
3. Copy the file.
  - Windows®: Copy the file to your designated library folder. The default location is **My Documents\TI-Nspire\MyLib**.
  - Mac®: Copy the file to your designated library folder. The default location is **Documents/TI-Nspire/MyLib**.

- Handheld: Connect the handheld to your computer, open the TI-Nspire™ software, and copy the library file to the handheld's **MyLib** folder.
4. Activate the new library objects.
- From the TI-Nspire™ Software **Tools** menu, click **Refresh Libraries**.

Handheld: Press ctrl menu, and click **Refresh Libraries**.

# Using the TI-SmartView™ Emulator

With three layout options to choose from, teachers will find that the emulator facilitates classroom presentations. In the teacher software, layout options are:

- Handheld Only
- Keypad + SideScreen
- Handheld + SideScreen

In the student software, the TI-SmartView™ emulates the keypad, which along with the handheld view, gives students the ability to drive the software as if using a handheld.

## Opening the TI-SmartView™ Emulator

The TI-SmartView™ emulator is located in the Documents Workspace. To open the emulator view:

1. Open the Documents Workspace.
2. Click , which is located in the Documents Toolbox.

In the teacher software, the handheld is displayed with Handheld and SideScreen panels open in computer mode as shown in the following illustration. You can use the keypad on the emulated handheld, but the document won't appear on the emulated handheld screen until you switch to Handheld mode.

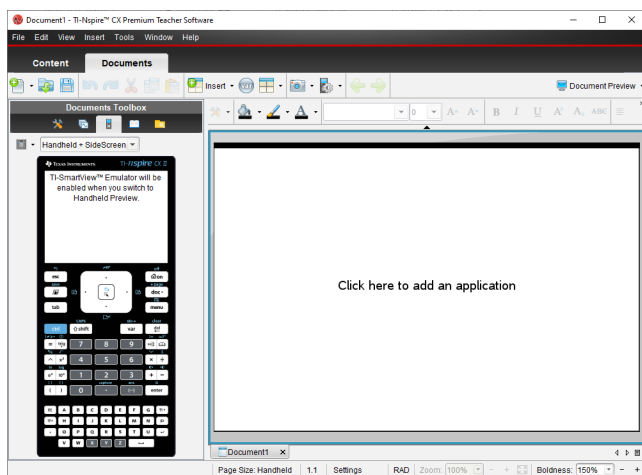

In the student software, the TI-Nspire™ CX II keypad is displayed with the side screen open in computer mode. You can use the keypad on the emulated handheld to work with the document in the side screen in either computer mode or handheld mode.

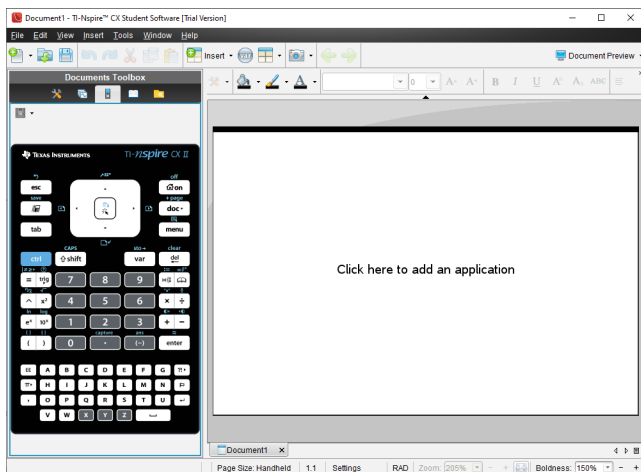

3. Click **View > Handheld**.

—or—

Click  in the status bar to switch to handheld mode.

## Choosing Display Options

In the teacher software, use this option to choose how to display the emulator in the software window.

1. In the emulator panel, click .

—or—

Click **File > Settings > TI-SmartView™ Options**.

2. Select one of the following options:

- **Handheld Only.** Displays the emulated handheld and hides the workspace and other panels.

**Note:** To keep the Handheld Only display in front of other application windows, click **Always in Front** at the top right of the TI-SmartView™ panel.

- **Keypad + SideScreen.** Opens a larger view of the keypad along with the side screen.
- **Handheld + SideScreen.** Opens the entire emulated handheld along with the side screen.

## Changing the Faceplate

To select a faceplate option:

1. In the emulator panel, click  to open the menu.

—or—

Click **File > Settings > TI-SmartView™ Options**.

2. Select one of the following options:

- Dark
- Light
- Outline

### Changing the Width of the TI-SmartView™ Panel

To change the width of the TI-SmartView™ emulator panel:

- ▶ Click the right edge of the panel and drag it until it is the width you want.

### Changing the Size of the Screen in the Workspace

When in handheld mode, use the Scale to change the size of the screen.

- ▶ Drag the slider to the appropriate scale percentage. The scale slider is located on the far right side of the status bar, at the bottom of the TI-Nspire™ window. Scale percentages range from 100% to 200%. The default scale is 150%.



**Note:** If computer mode is selected, you cannot change the size of the workspace.

### Working with the Emulated Handheld

To input data and work with files on the emulator, you can use the computer keyboard, TI-SmartView™ keypad, TI-Nspire™ menus and icons, or any combination of these.

**Note:** Within one command, you cannot use a combination of both the keypad and the keyboard. For example, you cannot press **Ctrl** on the keyboard and click **menu** on the emulator to open a context menu.

For the most part, you can perform any function in the TI-SmartView™ emulator that you can perform on the handheld. Keys and applications operate the same way.

**Note:** If you switch to Computer mode, you can still use most of the keys on the emulated handheld or keypad and all keystrokes are reflected in the workspace. However, some key combinations may only work in Handheld mode.

As you click keys on the emulator or press keys on the keyboard that activate keys on the emulator, those keys change color, making it easy for your audience to follow along. The last key selected stays highlighted.

In the teacher software, the emulator screen and the side screen are both interactive. You can click on icons and menu items on both screens. You can also right-click to display menus on both screens.

All handheld shortcuts and arrow functionality work from the computer keyboard. For example, to save a document, you can click **ctrl** **S** on the emulator keypad or you can press **Ctrl + S** on the computer keyboard. When using a Mac®, press **⌘ + S**.

## Using the Touchpad

You can operate the Touchpad on the TI-Nspire™ Touchpad keypad using either the touchpad on a laptop or by using the mouse to click the Touchpad. Areas of the Touchpad are highlighted as you click the arrow zones.

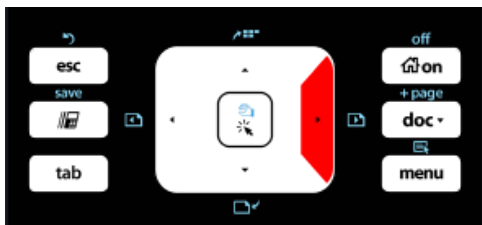

An arrow is highlighted when you press or tap it.

- Clicking the ◀, ▶, ▲, or ▼ keys on the Touchpad moves through menus one item at a time.
- Clicking and holding down an arrow on the Touchpad causes continual movement in the selected direction.
- Clicking and sliding the mouse across the Touchpad area enables you to move the mouse pointer.
- Clicking the middle of the Touchpad selects the highlighted menu option.

## Using Settings and Status

When working with the TI-SmartView™ emulator, you can change General Settings and Document Settings. For more information, see *Using the Documents Workspace*.

You can view all other settings, but you cannot change them in the TI-SmartView™ emulator. However, the ability to view these options provides teachers with an instructional tool when they need to show students how to set up a handheld.

To view settings and status:

1. Click to access the Home screen.
2. Click **Settings**.

Setting or Settings	Description
Language	You can open the languages menu and select a language, but you cannot save changes. To change the language, use the TI-Nspire™ menu <b>File &gt; Settings &gt; Change Language</b> option.
Handheld Setup	You can open the menus and select items to demonstrate which items to choose, but you cannot save any changes.

Setting or Settings	Description
Handheld Status	You can access the screen. The # symbol replaces any numeric values that would be displayed on the handheld.
About	You can open the About screen and view the software version. Other information that pertains only to the handheld hardware is marked as "Not Applicable."
Login	You can display the Login to Class screen and type in the User Name and Password fields. <b>Login</b> is not available.

## Changing TI-SmartView™ Options

You can change the emulator options, even when the emulator panel is closed.

1. In the teacher software, click **File > Settings > TI-SmartView™ Options**.

The TI-SmartView™ Options dialog box opens.

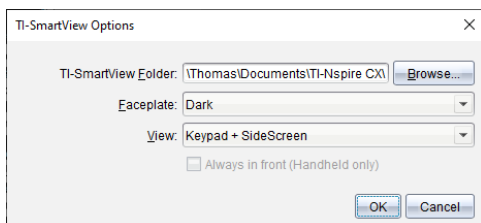

In the student software, click **File > Settings > Keypad Options**.

The Keypad Options dialog box opens.

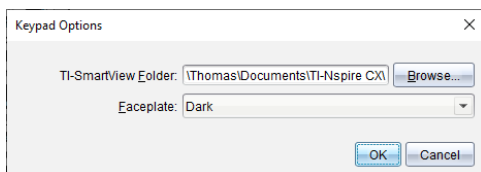

2. Click Browse to change the folder where documents are saved and accessed in the My Documents folder when using the emulator.

**Important:** If you change the TI-SmartView™ location, you must also copy or move the MyLib folder and paste it to the new location to see library objects.

The default location of MyLib is:

- Windows®: Documents\TI-Nspire\MyLib.
- Mac®: Documents/TI-Nspire/MyLib.

**Note:** Close and reopen the TI-Nspire™ application for the libraries to reflect the change.

3. Click ▼ to open the menu and select a faceplate.
4. In the teacher software, click ▼ to open the menu and select a view. If selecting Handheld Only, select **Always in Front** to keep this window on top of all other open applications.
5. Click **OK** to save the settings.

## **Working with Documents**

You can open multiple documents in the workspace by selecting **File > Open Document** from the menu or using keyboard shortcuts. When you switch between these documents, the emulated handheld shows only the current document. You can insert pages and problems using either the TI-Nspire™ menus or icons, keyboard shortcuts, or TI-SmartView™ menus or shortcuts.

### **Opening a Document**

You can open a document by navigating to it on the emulator, the same way you open a document on the handheld, or you click **File > Open Document**.

When you open a document using the emulator, you can only open documents that are in the folder displayed on the emulator (usually the My Documents folder, unless you specified a different folder in your TI-SmartView™ settings). When you open a document using the menu path, you can browse to find any TI-Nspire™ document on your computer or network. If you open a document using the emulated handheld, it replaces the document that was previously open.

**Note:** If the number of characters in the document's file path name exceeds 256 characters, the document cannot be opened and an error message is displayed. To avoid this error, keep file and folder names short or move files up in the file path.

### **Saving a Document**

When you save a document using the **File > Save Document** menu or icon, keyboard shortcuts, keypad shortcuts, or emulator menus, the document is saved in the same location where the file was opened. To save the file in another location or with a different name, click **File > Save As**.

## **Using Screen Capture**

To capture the current page, press **Ctrl + J** (Mac®: **⌘ + J**) on your keyboard or on the emulated handheld. The image is automatically placed in the Clipboard and in the TI-Nspire™ Screen Capture window. You can paste the image into another application without having to take additional steps. This feature is only available when the TI-SmartView™ panel is active and the workspace is in Handheld mode.

All other screen capture features work the same way they do in other areas of TI-Nspire™ software. For more information, see *Capturing Screens*.



# Regulatory Information

## USA FCC Information Concerning Radio Frequency Interference

Product Name	FCC ID
TI-Nspire™ Navigator™ Wireless Cradle	V7R-TINAVWC2
TI-Nspire™ Navigator™ Access Point	V7R-TINAVAP2
TI-Nspire™ CX Wireless Network Adapter	V7R-TINAVWNA
TI-Nspire™ CX Navigator™ Access Point	V7R-TINAVAP3
TI-Nspire™ CX Navigator™ Wireless Network Adapter – v2	V7R-TINAVWNA2

### FCC Compliance Statement

This equipment has been tested and found to comply with the limits for a Class B digital device, pursuant to Part 15 of the FCC Rules.

Operation is subject to the following two conditions: (1) These devices may not cause harmful interference, and (2) these devices must accept any interference received, including interference that may cause undesired operation.

The device for the band 5150-5250 MHz is only for indoor usage to reduce potential for harmful interference to co-channel mobile satellite systems.

### RF Radiation Exposure and Hazard Statement

To ensure compliance with Federal Communications Commission (USA) requirements, (SAR limit is 1.6 W/kg averaged over one gram of tissue), the products listed in the following table have been evaluated under FCC Bulletin OET 65C and found to be compliant with the requirements in 47 CFR Part 2.1093 for RF exposure from radio frequency devices.

The highest SAR value reported under this standard during product certification when worn on the body:

Product Name	SAR Value
TI-Nspire™ Navigator™ Wireless Cradle	0.562 W/kg
TI-Nspire™ Navigator™ Access Point	0.995 W/kg
TI-Nspire™ CX Wireless Network Adapter	0.994 W/kg
TI-Nspire™ CX Navigator™ Access Point	0.433 W/Kg
TI-Nspire™ CX Navigator™ Wireless Network Adapter – v2	0.716 W/Kg

Using higher gain antennas and types of antennas not covered under the FCC certification of this product is not allowed. Installers of the radio and end users of the product must adhere to the installation instructions provided in this manual.

This transmitter must not be co-located or operating in conjunction with any other antenna or transmitter.

## **Non-modification Statement**

Use only the integral antenna supplied by the manufacturer when operating these devices. Unauthorized antennas, modifications, or attachments could damage the TI-Nspire™ Navigator™ Cradle, TI-Nspire™ Navigator™ Access Point, TI-Nspire™ CX Wireless Network Adapter, TI-Nspire™ CX Navigator™ Access Point, or TI-Nspire™ CX Navigator™ Network Adapter – v2 and violate FCC regulations. Any changes or modifications not expressly approved by the party responsible for compliance could void the user's authority to operate this equipment.

## Canadian IC Information

Product Name	IC
TI-Nspire™ Navigator™ Wireless Cradle	451E-TINAVWC2
TI-Nspire™ Navigator™ Access Point	451F-TINAVAP2
TI-Nspire™ CX Wireless Network Adapter	451E-TINAVWNA
TI-Nspire™ CX Navigator™ Access Point	451F-TINAVAP3
TI-Nspire™ CX Navigator™ Wireless Network Adapter – v2	451F-TINAVWNA2

### Industry Canada Statement

This device complies with Industry Canada license-exempt RSS standard(s). Operation is subject to the following two conditions:

1. This device may not cause interference, and
2. This device must accept any interference, including interference that may cause undesired operation of the device.

To ensure compliance with Industry Canada requirements, (SAR limit is 1.6 W/kg averaged over one gram of tissue), these products have been evaluated and found compliant in accordance with Industry Canada RSS-102 with respect to the Safety Code 6 for Human Exposure to RF Fields.

The highest SAR value reported under this standard during product certification when worn on the body:

Product Name	SAR Value
TI-Nspire™ Navigator™ Wireless Cradle	0.562 W/kg
TI-Nspire™ Navigator™ Access Point	0.995 W/kg
TI-Nspire™ CX Wireless Network Adapter	0.994 W/kg
TI-Nspire™ CX Navigator™ Access Point	0.433 W/Kg
TI-Nspire™ CX Navigator™ Wireless Network Adapter – v2	0.716 W/Kg

Equipment (or its transmit antenna) that is installed outdoors is subject to licensing and not supported by the listed products.

More information may be found in RSS-102 (<http://www.ic.gc.ca/eic/site/smt-gst.nsf/eng/sf01904.html>) and in Canada's Safety Code 6 ([http://www.hc-sc.gc.ca/ewh-semt/pubs/radiation/radio\\_guide-lignes\\_direct-eng.php](http://www.hc-sc.gc.ca/ewh-semt/pubs/radiation/radio_guide-lignes_direct-eng.php)).

Under Industry Canada regulations, this radio transmitter may only operate using an antenna of a type and maximum (or lesser) gain approved for the transmitter by Industry Canada. To reduce potential radio interference to other users, the antenna type and its gain should be so chosen that the equivalent isotropically radiated power (e.i.r.p.) is not more than that necessary for successful communication.

The device for the band 5150-5250 MHz is only for indoor usage to reduce potential for harmful interference to co-channel mobile satellite systems.

CAN ICES-3(B)/NMB-3(B)

### Industrie Canada Déclaration

Ce dispositif est conforme à la norme (s) RSS de la licence-exonéré Industrie Canada. Opération est soumise aux deux conditions suivantes :

1. Ce dispositif ne peut pas causer de brouillage, et
2. Ce dispositif doit accepter toute interférence, y compris le brouillage qui peut causer intempestif de fonctionnement du dispositif.

Pour assurer la conformité avec les exigences d'Industrie Canada, (limite de Das est de 1,6 W/kg en moyenne pour un gramme de tissu), ces produits ont été évalués et jugés conformes conformément à Industrie Canada, CNR-102 en ce qui concerne le Code de sécurité 6 pour l'exposition humaine aux champs RF.

La valeur SAR la plus élevée signalée en vertu de cette norme lors de la certification du produit lorsqu'il est porté sur le corps :

Nom du produit	SAR Verdien
TI-Nspire™ Navigator™ Wireless Cradle	0.562 W/kg
TI-Nspire™ Navigator™ Access Point	0.995 W/kg
TI-Nspire™ CX Wireless Network Adapter	0.994 W/kg
TI-Nspire™ CX Navigator™ Access Point	0.433 W/Kg
TI-Nspire™ CX Navigator™ Wireless Network Adapter – v2	0.716 W/Kg

Équipement (ou son antenne de transmission) qui est installé à l'extérieur est soumis à licence et pas pris en charge par les produits énumérés.

On trouvera plus d'informations dans le CNR-102 (<http://www.ic.gc.ca/eic/site/smt-gst.nsf/eng/sf01904.html>) et dans Code de sécurité 6 notre ([http://www.hc-sc.gc.ca/ewh-semb/pubs/radiation/radio\\_guide-lignes\\_direct-eng.php](http://www.hc-sc.gc.ca/ewh-semb/pubs/radiation/radio_guide-lignes_direct-eng.php)).

En vertu de la réglementation d'Industrie Canada, cet émetteur radio risquera uniquement à l'aide d'une antenne de type et de gain maximum (ou moins) pour l'émetteur a été approuvé par Industrie Canada. Pour réduire les interférences radio potentielles à d'autres utilisateurs, le type d'antenne et son gain doivent être choisie que la puissance isotrope rayonnée équivalente (p.i.r.e.) n'est pas plus que celui nécessaire à une communication efficace.

Le dispositif pour la bande 5150-5250 MHz est seulement pour utilisation intérieure réduire le risque de brouillage préjudiciable aux systèmes mobiles par satellite dans la même voie.

# Australia Regulatory Compliance

## EMC Compliance Statement

In accordance with the provisions on the Radio Regulations of the AS/NZS of Australia, the following radio transmission equipment, after examination, conforms to the provisions:

- TI-Nspire™ Navigator™ Wireless Cradle
- TI-Nspire™ Navigator™ Access Point
- TI-Nspire™ CX Wireless Network Adapter
- TI-Nspire™ CX Navigator™ Access Point
- TI-Nspire™ CX Navigator™ Wireless Network Adapter – v2

Operation is subject to the following two conditions: (1) These devices may not cause harmful interference, and (2) these devices must accept any interference received, including interference that may cause undesired operation.

## RF Radiation Exposure and Hazard Statement

The products are designed to not exceed the limits for exposure to radio waves recommended by international guidelines, (SAR limit is 2.0 W/kg averaged over 10 grams of tissue). The products listed in the following table have been evaluated under ICNIRP Guidelines for RF exposure from radio frequency devices.

The highest SAR value reported under this standard during product certification when worn on the body:

Product Name	SAR Value
TI-Nspire™ Navigator™ Wireless Cradle	0.242 W/kg
TI-Nspire™ Navigator™ Access Point	0.497 W/kg
TI-Nspire™ CX Wireless Network Adapter	0.389 W/kg
TI-Nspire™ CX Navigator™ Access Point	0.348 W/kg
TI-Nspire™ CX Navigator™ Wireless Network Adapter – v2	0.453 W/kg

Using higher gain antennas and types of antennas not covered under ICNIRP is not allowed. Installers of the radio and end users of the product must adhere to the installation instructions provided in this manual. This transmitter must not be co-located or operating in conjunction with any other antenna or transmitter.

## Japan Regulatory Compliance

### EMC Compliance Statement

In accordance with the provisions on the Radio Regulations of the Den-An Law of Japan, the following radio transmission equipment, after examination, conforms to the provisions.

- TI-Nspire™ Navigator™ Wireless Cradle
- TI-Nspire™ Navigator™ Access Point
- TI-Nspire™ CX Wireless Network Adapter
- TI-Nspire™ CX Navigator™ Access Point
- TI-Nspire™ CX Navigator™ Wireless Network Adapter – v2

Operation is subject to the following two conditions: (1) These devices may not cause harmful interference, and (2) these devices must accept any interference received, including interference that may cause undesired operation.

### RF Radiation Exposure and Hazard Statement

The products are designed to not exceed the limits for exposure to radio waves recommended by international guidelines, (SAR limit is 2.0 W/kg averaged over 10 grams of tissue). The products listed in the following table have been evaluated under ICNIRP Guidelines for RF exposure from radio frequency devices.

The highest SAR value reported under this standard during product certification when worn on the body:

Product Name	SAR Value
TI-Nspire™ Navigator™ Wireless Cradle	0.242 W/kg
TI-Nspire™ Navigator™ Access Point	0.497 W/kg
TI-Nspire™ CX Wireless Network Adapter	0.389 W/kg
TI-Nspire™ CX Navigator™ Access Point	0.348 W/kg
TI-Nspire™ CX Navigator™ Wireless Network Adapter – v2	0.453 W/kg

Using higher gain antennas and types of antennas not covered under ICNIRP is not allowed. Installers of the radio and end users of the product must adhere to the installation instructions provided in this manual. This transmitter must not be co-located or operating in conjunction with any other antenna or transmitter.

# ***Korea Regulatory Compliance***

## **EMC Compliance Statement**

In accordance with the provisions on the Radio Regulations of the MSIP of Korea, the following radio transmission equipment, after examination, conforms to the provisions.

- TI-Nspire™ Navigator™ Wireless Cradle
- TI-Nspire™ Navigator™ Access Point
- TI-Nspire™ CX Wireless Network Adapter
- TI-Nspire™ CX Navigator™ Access Point
- TI-Nspire™ CX Navigator™ Wireless Network Adapter – v2

Operation is subject to the following two conditions: (1) These devices may not cause harmful interference, and (2) these devices must accept any interference received, including interference that may cause undesired operation.

## ***Class B Warning Statement***

<b>Class</b>	<b>Notification</b>
CLASS B	EMC registration is done on this equipment mainly for a house use (Class B) and also can be used in all areas.

## **RF Radiation Exposure and Hazard Statement**

The products are designed to not exceed the limits for exposure to radio waves recommended by international guidelines, (SAR limit is 2.0 W/kg averaged over 10 grams of tissue). The products listed in the following table have been evaluated under ICNIRP Guidelines for RF exposure from radio frequency devices.

The highest SAR value reported under this standard during product certification when worn on the body:

<b>Product Name</b>	<b>SAR Value</b>
TI-Nspire™ Navigator™ Wireless Cradle	0.242 W/kg
TI-Nspire™ Navigator™ Access Point	0.497 W/kg
TI-Nspire™ CX Wireless Network Adapter	0.389 W/kg
TI-Nspire™ CX Navigator™ Access Point	0.348 W/kg
TI-Nspire™ CX Navigator™ Wireless Network Adapter – v2	0.453 W/kg

Using higher gain antennas and types of antennas not covered under ICNIRP is not allowed. Installers of the radio and end users of the product must adhere to the installation instructions provided in this manual. This transmitter must not be co-located or operating in conjunction with any other antenna or transmitter.

## China SRRC CMIIT Identification

### EMC Compliance Statement

In accordance with the provisions on the Radio Regulations of the People's Republic of China, the following radio transmission equipment, after examination, conforms to the provisions with its SRRC ID:

Product Name	CMIIT ID
TI-Nspire™ Navigator™ Wireless Cradle	2010DJ5746
TI-Nspire™ Navigator™ Access Point	2012DJ1441
TI-Nspire™ CX Wireless Network Adapter	2011DJ1546
TI-Nspire™ CX Navigator™ Access Point	2013AJ6928
TI-Nspire™ CX Navigator™ Wireless Network Adapter – v2	2013AJ6929

Operation is subject to the following two conditions: (1) These devices may not cause harmful interference, and (2) these devices must accept any interference received, including interference that may cause undesired operation.

### RF Radiation Exposure and Hazard Statement

The products are designed to not exceed the limits for exposure to radio waves recommended by international guidelines, (SAR limit is 2.0 W/kg averaged over 10 grams of tissue). The products listed in the following table have been evaluated under ICNIRP Guidelines for RF exposure from radio frequency devices.

The highest SAR value reported under this standard during product certification when worn on the body:

Product Name	SAR Value
TI-Nspire™ Navigator™ Wireless Cradle	0.242 W/kg
TI-Nspire™ Navigator™ Access Point	0.497 W/kg
TI-Nspire™ CX Wireless Network Adapter	0.389 W/kg
TI-Nspire™ CX Navigator™ Access Point	0.348 W/kg
TI-Nspire™ CX Navigator™ Wireless Network Adapter – v2	0.453 W/kg

Using higher gain antennas and types of antennas not covered under ICNIRP is not allowed. Installers of the radio and end users of the product must adhere to the installation instructions provided in this manual. This transmitter must not be co-located or operating in conjunction with any other antenna or transmitter.



# Taiwan Regulatory Compliance

## EMC Compliance Statement

In accordance with the provisions of Bureau of Standards, Metrology and Inspection for Taiwan, the following radio transmission equipment, after examination, is in conformance:

Product Name
TI-Nspire™ Navigator™ Wireless Cradle
TI-Nspire™ Navigator™ Access Point
TI-Nspire™ CX Wireless Network Adapter
TI-Nspire™ CX Navigator™ Access Point
TI-Nspire™ CX Navigator™ Wireless Network Adapter – v2

Operation is subject to the following two conditions: (1) These devices may not cause harmful interference, and (2) these devices must accept any interference received, including interference that may cause undesired operation.

## RF Radiation Exposure and Hazard Statement

The products are designed to not exceed the limits for exposure to radio waves recommended by international guidelines, (SAR limit is 2.0 W/kg averaged over 10 grams of tissue). The products listed in the following table have been evaluated under ICNIRP Guidelines for RF exposure from radio frequency devices.

The highest SAR value reported under this standard during product certification when worn on the body:

Product Name	SAR Value
TI-Nspire™ Navigator™ Wireless Cradle	0.242 W/kg
TI-Nspire™ Navigator™ Access Point	0.497 W/kg
TI-Nspire™ CX Wireless Network Adapter	0.389 W/kg
TI-Nspire™ CX Navigator™ Access Point	0.348 W/kg
TI-Nspire™ CX Navigator™ Wireless Network Adapter – v2	0.453 W/kg

Using higher gain antennas and types of antennas not covered under ICNIRP is not allowed. Installers of the radio and end users of the product must adhere to the installation instructions provided in this manual. This transmitter must not be co-located or operating in conjunction with any other antenna or transmitter.

## Warning Statements

**Warning!** Install the TI-Nspire™ Navigator™ Access Point or TI-Nspire™ CX Navigator™ Access Point in such a manner as to maintain a minimum of 20 cm (7.9 inches) separation distance between the radiating element(s) and all persons. This safety warning conforms to FCC radio frequency exposure limits.

**Warning!** Do not touch or move the TI-Nspire™ Navigator™ Access Point or or TI-Nspire™ CX Navigator™ Access Point when the antennas are transmitting or receiving.

**Warning!** The TI-Nspire™ Navigator™ Access Point, TI-Nspire™ Navigator™ Wireless Cradle, TI-Nspire™ CX Wireless Network Adapter, TI-Nspire™ CX Navigator™ Access Point, and TI-Nspire™ CX Wireless Network Adapter - v2 are intended for indoor use only. Do not install the device nor operate it outdoors.

**Warning!** Intentional radiators, such as the TI-Nspire™ Navigator™ Access Point, TI-Nspire™ Navigator™ Wireless Cradle, TI-Nspire™ CX Wireless Network Adapter. TI-Nspire™ CX Navigator™ Access Point, and TI-Nspire™ CX Wireless Network Adapter - v2 are not intended to be operated with any antenna(s) other than those furnished by Texas Instruments. An intentional radiator may only be operated with the antenna(s) with which it is authorized.

**Warning!** The TI-Nspire™ Navigator™ Access Point radio(s) and TI-Nspire™ CX Navigator™ Access Point radio(s) are disabled by default and can be enabled only by the system administrator using the Management software application.

**Warning!** The radio frequency band, operating channels, and transmit power depend on the country of operation specified by the system administrator during setup and configuration using the Management software.

**Warning!** Only qualified personnel must perform installation. Read and follow all warning notices and instructions marked on the product or included in the documentation

### ***Important for Safe AC Adapter Operation***

In addition to the careful attention devoted to quality standards in the manufacture of your TI product, safety is a major factor in the design of every product. However, safety is your responsibility as well. This section lists important information that will help assure your enjoyment and proper use of this TI product and accessory equipment. Please read it carefully before operating and using your product.

#### **Installation**

- **Read and follow Instructions:** You should read all the safety and operating instructions before operating the product. Follow all operating instructions.
- **Retain Instructions:** You should save all the safety and operating instructions for future reference.
- **Heed Warnings:** Comply with all warnings on the product and in the operating instructions.
- **Use the Recommended AC adapter:** You must use the adapter that comes with your product.
- **Check Power Sources:** The AC adapter for your TI product must be used with an AC100V-230V 50Hz/60Hz supply outlet. If you are not sure of the type of power supplied to your home, consult your dealer or local power company.
- **Be Careful of Overloading:** Do not overload wall outlets or extension cords, as this can result in a risk of fire or electric shock. Overloaded AC outlets, extension cords, frayed power cords, damaged or cracked wire insulation, and broken plugs are

dangerous. Periodically examine the cord, and if its appearance indicates damage or deteriorated insulation, have it replaced by your service technician.

- **Protect Power Cords:** Route power supply cords so that they are not likely to be walked on or pinched by items placed upon or against them. Pay particular attention to cords where they are attached to plugs and convenience receptacles, and examine the point where the power cord attaches to the TI product.
- **Check Ventilation:** Slots and openings in the enclosure are provided for ventilation to ensure reliable operation of the TI product and to protect it from overheating. Do not block or cover these openings. Never block these openings by placing the TI product on a bed, sofa, rug, or other similar surface. Never place the TI product near or over a radiator or heat register, or any other heat source (including amplifiers). Do not place the TI product in a built-in installation, such as a bookcase or equipment rack, unless you provide proper ventilation.
- **Do Not Use Accessories:** Do not use attachments, unless they are recommended by TI, as they may cause electrical or fire hazards.
- **Do Not Use Near Water:** Do not use the TI product near water; for example, near a bathtub, sink or laundry tub, in a wet basement or near a swimming pool.
- **Do Not Place Near a High Temperature Source:** Do not use the TI product near a source of heat such as a kitchen range, a fireplace, or a radiator.
- **Use Caution in Mounting the TI Product:** Do not place the TI product on an unstable surface. The TI product may fall, causing serious injury to a child or adult, as well as serious damage to the TI product.
- **Do Not Use Near Medical Equipment:** Do not operate the product near equipment that is susceptible to electrical interference, or is used for medical purposes. Do not use the product near a pacemaker or a patient care area in a hospital.

### **Important Information**

- Wait at least 10 seconds between disconnecting and reconnecting the TI product with the AC power adapter.
- Unplug the product from the wall outlet carefully, as the AC adapter may be hot.

### **Use and Maintenance**

- **Unplug Power Before Cleaning:** Do not use liquid or aerosol cleaners. Use a damp cloth for cleaning.
- **Keep Objects Out of Openings:** Never push objects of any kind into the TI product through openings such as the ventilation holes, as they may touch high voltage circuits and "short out" parts, which could result in a fire or electric shock. Never spill liquid on the TI product.
- **Protect From Lightning:** Unplug the TI product during a lightning storm, or when leaving it unattended and unused for a long period. Remove the power adapter from the wall outlet, and disconnect the cable system. This will prevent damage to the TI product due to lightning and power line surges. Take care not to touch the metal portion of the TI product or cables in a lightning storm.

### **Service**

- Refer Servicing to Qualified Service Personnel under the Conditions Listed Below:

- If the power supply cord or plug is damaged.
  - If liquid has been spilled or objects have fallen into the product.
  - If the product has been exposed to rain or water.
  - If the product does not operate normally as per the operating instructions.
  - If the product has been dropped or the case has been damaged.
  - When the product exhibits a distinct change in operation, such as the inability to complete its self-check.
- **Require Safety Check:** Upon completion of any service or repairs to the product, ask the service technician to perform the recommended safety checks to verify that the product is in a safe operating condition.

## General Information

### ***Online Help***

[education.ti.com/eguide](http://education.ti.com/eguide)

Select your country for more product information.

### ***Contact TI Support***

[education.ti.com/ti-cares](http://education.ti.com/ti-cares)

Select your country for technical and other support resources.

### ***Service and Warranty Information***

[education.ti.com/warranty](http://education.ti.com/warranty)

Select your country for information about the length and terms of the warranty or about product service.

Limited Warranty. This warranty does not affect your statutory rights.

Texas Instruments Incorporated

12500 TI Blvd.

Dallas, TX 75243

# Index

## A

account, teacher .....	16
activities	
copying .....	48
filtering .....	46
keyword searches .....	47
opening .....	47
saving .....	47
Activities file .....	33
ActivityTypes file .....	34
adapter	
adding to network .....	23-24
connecting to handhelds .....	15
adding	
(x,y) numerical input questions .....	188
applications .....	97
classes .....	137
colors .....	92
copyrights .....	177
copyrights to documents (.tns) .....	104
drop points questions .....	190
equation questions .....	184
files to lesson bundles .....	107-108
files to transfer list .....	69
images in Quick Poll .....	133
images to pages .....	133
images to questions .....	180
links .....	43
lists questions .....	191
Master Documents .....	245
open response questions .....	183
pages .....	101
problems .....	101
questions .....	180, 182
shortcuts .....	42
shortcuts to lesson bundles .....	114
students to classes .....	142
teacher equations to graphs .....	233
teacher points to graphs .....	231
applications	
adding .....	97
deleting .....	101
grouping .....	100
inserting images .....	133
Question .....	176
swapping .....	98

arranging	
captured screens .....	122
aspect ratio	
changing (Review Workspace) .....	217
assignments	
exporting .....	242
redistributing .....	246
removing .....	248
renaming .....	247
saving .....	239
viewing individual .....	238
viewing summary .....	237
associating handhelds with a	
network .....	11
Attendance file .....	34

## B

bar charts	
organizing .....	221
viewing (Review Workspace) .....	211
beginning class sessions .....	149

## C

Capture Class	
printing screens .....	127
saving screens .....	126
view options .....	120
capture class tool .....	118
capture page option .....	128
Capture Selected Handheld option .....	129
captured screens	
rearranging .....	122
refreshing .....	122
capturing	
active pages in documents .....	128
handheld current screens .....	117
images in handheld mode .....	117
pages in active documents .....	117
screen stacks .....	123
student handhelds .....	118
changing	
class views .....	150
colors .....	220
General Settings .....	84
Graphs & Geometry settings .....	86
language .....	32
links .....	44
passwords .....	167

scores .....	242	converting	
changing screen size .....	261	page size; page size, converting;	
Class Record .....	156	preview, setting	
canceling file transfers .....	166	document; setting	
checking file transfer status .....	165	document preview	93
viewing file properties .....	166	copying	
Class Session file .....	35	activities .....	48
class sessions		handheld images .....	117
beginning .....	149	images .....	128
ending .....	149	images in handheld mode .....	117
Class Workspace .....	137	lesson bundles .....	113
classes		Live Presenter keypress history	173
adding classes .....	137	screens .....	132
adding students .....	142	student information .....	156
assigning students .....	152	copyrights	
changing views .....	150	adding .....	177
Class Record .....	137, 156	adding to documents (.tns) .....	104
copying student information .....	156	creating	
creating classes .....	137	classes .....	137
moving students to .....	155	lesson bundles .....	106, 113
removing classes .....	147	passwords .....	169
removing students from .....	144	creating documents (.tns) .....	88
seating charts .....	150-151		
sending files .....	48	<b>D</b>	
student lists .....	150	data	
clearing		viewing in tables (Review	
Live Presenter keypress history	173	Workspace) .....	213
closing		viewing student responses .....	216
Live Presenter .....	175	defining	
Transfer Tool .....	75	settings .....	32
closing documents (.tns) .....	91	deleting	
collecting		applications .....	101
files .....	160	classes .....	147
missing files .....	246	documents (.tns) .....	91
colors		files .....	73
changing for student responses	220	files (Portfolio Workspace) .....	248
colors, adding .....	92	images .....	135
comparing		keypress history in Live	
screens .....	125	Presenter .....	173
configuring plot lists .....	218	lesson bundles .....	113-114
connecting		pages .....	100, 102
handhelds to wireless adapters	15	problems .....	100, 102
content		shortcuts .....	42
viewing on handhelds .....	51	student information .....	144
Content Explorer .....	80	Destination folder	
content workspace		editing .....	72
exploring .....	37	displaying	
Content Workspace .....	37	student responses .....	209

teacher handhelds .....	119		
TI-SmartView™ emulator in teacher software .....	260		<b>F</b>
document settings managing on connected handhelds .....	58	features	
documents (.tns)		refreshing screen captures .....	122
changing General Settings .....	84	File transfers	
closing .....	91	stopping .....	75
creating .....	88	files	
deleting .....	91	adding to lesson bundles ...	107-108, 112
opening .....	54, 89	adding to transfer list .....	69
opening (Class Workspace) .....	214	canceling transfers .....	166
opening (Content Workspace) ..	47	checking transfer status .....	165
opening (Portfolio Workspace) ..	215	collecting .....	160
opening with TI-SmartView™ emulator .....	264	collecting missing .....	246
printing .....	103	copying/pasting from lesson bundles .....	111
properties .....	104	deleting from lesson bundles ...	112
protecting .....	105	image file types .....	133
read-only .....	105	importing (Portfolio Workspace)	240
saving .....	55, 90	opening in lesson bundles .....	110-111
saving in emulator .....	264	pasting from lesson bundles ...	112
switching between .....	94	previewing (Portfolio Workspace) .....	241
viewing .....	95	properties .....	166
DragScreen feature .....	117	redistributing (Portfolio Workspace) .....	246
drop points questions		refreshing list in lesson bundles	112-113
adding .....	190	removing (Portfolio Workspace)	248
		removing from Transfer List ...	71
		renaming in lesson bundles ...	112
<b>E</b>		saving (Portfolio Workspace) ...	234, 239
editing		sending .....	48, 158
Destination folder .....	72	sending missing .....	247
scores .....	242	viewing properties .....	166
emailing lesson bundles .....	115	working with files on connected handhelds .....	53
emulator, See TI-SmartView™		Files	
emulator .....	78	deleting .....	73
ending class sessions .....	149	filtering activities .....	46
equation questions		final scores, changing .....	242
adding .....	184	formatting text .....	91
exploring		formatting toolbar	
content workspace .....	37	hiding .....	92
resources pane .....	37	showing .....	92
exporting			
data .....	242	<b>G</b>	
student scores (Portfolio Workspace) .....	242	Gallery view .....	120
		graphs	
		adding teacher equations .....	233



adding teacher points .....	231	selecting .....	134
viewing data (Review Workspace) .....	212	TI-Nspire™ applications .....	133
Graphs & Geometry settings .....	86	importing files (Portfolio Workspace)	240
grouping		inserting	
responses .....	221	images in questions .....	180
grouping applications .....	100	images in Quick Poll .....	133
		images to pages .....	133
		installing a handheld OS update ....	63
<b>H</b>		<b>K</b>	
handhelds		keypress history	
associating with a network .....	11	copying .....	173
capturing current screens .....	117	hiding in Live Presenter .....	172
capturing selected handhelds ..	129	showing in Live Presenter .....	172
capturing student screens .....	118	viewing in Live Presenter .....	172
changing settings on connected	58	keyword searches .....	47
checking for OS updates .....	62		
connecting to adapters .....	15	<b>L</b>	
copying images .....	117	language	
installing OS update .....	63	changing .....	32
locating using Identify Selected	66	lesson bundles	
managing from teacher's		adding files .....	107-108, 112
computer .....	58	adding shortcuts to .....	114
pasting images .....	117	copying .....	114
renaming .....	66	copying/pasting .....	113-114
transferring files .....	58	copying/pasting files .....	111
viewing content on connected .	51	creating .....	106-107, 113
working with files on connected	53	deleting .....	113-114
hiding		deleting files .....	112
handheld display in Live		emailing .....	115
Presenter .....	171	opening .....	109-110, 112, 114
Live Presenter keypress history	172	opening files .....	110-111
presenter handheld .....	171	packaging .....	115
responses .....	209, 223-224	packaging pages .....	114
student names .....	119	pasting .....	114
student names in Live Presenter	170	refreshing list of files .....	112-114
hiding format toolbar .....	92	renaming .....	113-114
		renaming files .....	112
<b>I</b>		sending .....	114, 116
Identify Selected .....	66	libraries .....	254
images		Linear Algebra functions .....	257
adding to questions .....	180	refreshing .....	256
deleting .....	135	restoring .....	257
file types .....	133	library objects	
inserting .....	133	creating shortcuts .....	257
moving .....	134	private .....	255
Quick Poll .....	133	public .....	255
resizing .....	135	using .....	256
saving .....	117, 128		



panes		lists	191
resource	37	multiple choice	182
passwords		open response	183
changing for teacher	17	responding	196
resetting for students	167	Self Check mode	183
setting	169	suggested responses	184
pasting		using the Question application	176
handheld images	117	questions (students)	
images	128	checking answers	198
images in handheld mode	117	toolbar options	195
lesson bundles	113	types of	195
screens	132	Quick Poll	
PDF		images	133
save document as	103	opening	200
playing		polling students	202
Live Presenter recording	175	saving polls	204
plots		stopping polls	203
configuring lists	218	viewing results	204
points		Quick Poll questions	
adding to graphs (Review		clearing answers	198
Workspace)	231	responding	196
polling students	202	types	197
polls			
stopping	203	<b>R</b>	
viewing results	204	randomize screen option	119
Portfolio Workspace	236	read-only documents (.tns)	105
preparing handhelds remotely	58	rearranging	
Press-to-Test		captured screens	122
managing on connected		recording	
handhelds	58	Live Presenter presentation	174
preview, printed document	104	starting Live Presenter recording	174
print preview	104	redistributing assignments	246
printing		refreshing	
captured screens	127	captured screens	122
printing documents (.tns)	103	removing	
problems		classes	147
adding	101	files	248
deleting	100, 102	images	135
renaming	103	links	44
protecting documents (.tns)	105	students from classes	144
		removing files from Transfer list	71
<b>Q</b>		renaming	
questions		items (Portfolio Workspace)	247
(x,y) numerical input	188	lesson bundles	113-114
adding	180	renaming problems	103
adding images	180	reponses	
drop points	190	adding suggested	184
equation	184	reporting system use	33
		repositioning images	134

resetting student passwords .....	167	teacher preferences .....	119
resizing		Tiled view .....	120
images .....	135	zooming in/out .....	123
resources pane		screen stacks .....	123
exploring .....	37	screens	
responses		comparing .....	125
hiding .....	223	searching for activities .....	47
marking .....	226	seating charts .....	151
organizing .....	218	selecting	
showing .....	223, 226	images .....	134
showing correct .....	211	selecting pages .....	99
sorting .....	213	self-check	
restoring libraries .....	257	document types .....	178
Review tools .....	207	Self-Check mode .....	183
Review Workspace .....	206	sending	
		files to class .....	48, 158
		missing files .....	247
		sending session logs .....	35
		session logs	
		Activities .....	33
		activity types .....	34
		Attendance file .....	34
		Class Session .....	35
		managing session log files .....	35
		packaging .....	35
		sending .....	35
		settings	
		changing on connected	
		handhelds .....	58
		defining .....	32
		language .....	32
		teacher preferences .....	151
		TI-SmartView™ emulator .....	262
		sharing	
		Live Presenter recording .....	175
		shortcuts .....	42
		creating to library objects .....	257
		showing	
		correct responses .....	211
		handheld in Live Presenter .....	171
		Live Presenter handheld screen .....	173
		Live Presenter keypress history .....	172
		presenter handheld .....	171
		responses .....	223
		student names .....	119
		student names in Live Presenter .....	170
		student responses .....	209, 226
		showing format toolbar .....	92
<b>S</b>			
Save			
document as PDF .....	103		
saving			
activities to your computer .....	47		
captured images .....	117		
captured pages .....	131		
data as new document (Review			
Workspace) .....	235		
documents (.tns) .....	55		
documents (.tns) in emulator ..	264		
files to Portfolio Workspace .....	234		
handheld screens .....	131		
images .....	128		
Live Presenter recording .....	174		
Portfolio items .....	239		
saving documents (.tns) .....	90		
scores, editing .....	242		
Scratchpad			
clearing on connected			
handhelds .....	58		
screen capture tool .....	117		
screen captures			
Capture Class .....	117		
comparing screens .....	125		
copying .....	132		
Gallery view .....	120		
hiding student names .....	119		
Make Presenter option .....	126		
pasting .....	132		
showing student names .....	119		
stacks .....	123		

sorting		teacher preferences .....	151
Portfolio items .....	244	Teacher Tool Palette .....	177
responses .....	213	text formatting .....	91
student information .....	152	TI-Nspire™ CX Wireless Network Adapter	
starting		adding to network .....	23-24
Live Presenter recordings .....	174	connecting to handhelds .....	15
transfer .....	74	TI-Nspire™ Screen Capture Window	130
status		zooming in/out .....	130
of file transfers .....	165	TI-SmartView™	
stopping		capturing images .....	117
file transfers .....	75	DragScreen feature .....	117
Live Presenter .....	175	TI-SmartView™ emulator .....	78, 261
Live Presenter recording .....	174	capturing screens .....	264
polls .....	203	changing panel width .....	260-261
student handhelds		opening .....	259
capturing .....	118	opening documents (.tns) .....	264
student responses		options .....	263
individualizing .....	220	saving documents (.tns) .....	264
marking correct/incorrect .....	226	settings .....	262
organizing .....	218	TI-SmartView™ Emulator .....	259
showing/hiding .....	223, 226	Tiled view .....	120
viewing .....	208	toolbar	
students		text formatting .....	91
adding to classes .....	142	tools	
arranging in seating charts .....	151	capture class .....	118
changing classes .....	152	screen capture .....	117
changing names .....	154	tools menu .....	29
changing student IDs .....	154	Touchpad, navigating in emulator ..	262
checking login status .....	152	tracking system use .....	33
copying information .....	156	Transfer	
creating passwords .....	169	starting .....	74
deleting information .....	144	Transfer List	
displaying responses .....	209	removing files .....	71
moving information .....	155	Transfer Tool .....	67
polling .....	202	adding files .....	69
removing from classes .....	144	closing .....	75
resetting passwords .....	167	interface .....	67
responses .....	209	opening .....	69
setting passwords .....	169	removing files .....	71
viewing student list .....	150	transferring files	
suggested response .....	178	canceling .....	166
		checking transfer status .....	165
		transferring files to connected handhelds .....	58
<b>T</b>			
teacher account .....	16		
changing password .....	17		
changing user name .....	18		
teacher data, adding .....	231, 233		
teacher handhelds			
displaying .....	119		

## U

ungrouping	
applications .....	100-101
pages .....	100-101
user name, changing for teacher ...	18
Using the Preview Pane .....	39

## V

viewing	
answers .....	216
assignment summaries .....	236
bar charts/graphs (Review Workspace) .....	211
capture class options .....	120
captured screens .....	130
data (Review Workspace) .....	212-213
documents (.tns) .....	95
individual assignments .....	238
Live Presenter keypress history	172
live results .....	211
poll results .....	204
student responses .....	208, 216
views	
seating chart .....	150
student list .....	150
table (Review Workspace) .....	213

## W

windows	
TI-Nspire™ Screen Capture .....	130
wireless adapter	
adding to network .....	23-24
connecting to handhelds .....	15
wireless clients, adding to a network	11
workspaces .....	29
Class Workspace .....	137
Content Workspace .....	37
exploring .....	37
Portfolio Workspace .....	236
Review Workspace .....	206

## Z

zooming	
handheld preview .....	93
in/out .....	123, 130