

TI-30XS MultiView™

A Guide for Teachers

Developed by
Texas Instruments Incorporated

Activities developed by
Gary Hanson, Aletha Paskett, and Margo Lynn Mankus

Illustrated by
Jay Garrison and David Garrison

About the authors

Gary Hanson and **Aletha Paskett** are math teachers in the Jordan Independent School District in Sandy, Utah. They developed several of the activities and assisted in evaluating the appropriateness of the examples in the How to use the TI-30XS MultiView™ section of this guide.

Margo Lynn Mankus currently works in Mathematics and Technology Education at the State University of New York at New Paltz. She has reviewed and updated the materials for the TI-30XS MultiView and developed several activities for this guide.

Important notice regarding book materials

Texas Instruments makes no warranty, either express or implied, including but not limited to any implied warranties of merchantability and fitness for a particular purpose, regarding any programs or book materials and makes such materials available solely on an “as-is” basis. In no event shall Texas Instruments be liable to anyone for special, collateral, incidental, or consequential damages in connection with or arising out of the purchase or use of these materials, and the sole and exclusive liability of Texas Instruments, regardless of the form of action, shall not exceed the purchase price of this product. Moreover, Texas Instruments shall not be liable for any claim of any kind whatsoever against the use of these materials by any other party.

Permission is hereby granted to teachers to reprint or photocopy in classroom, workshop, or seminar quantities the pages in this work that carry a Texas Instruments copyright notice. These pages are designed to be reproduced by teachers for use in their classes, workshops, or seminars, provided each copy made shows the copyright notice. Such copies may not be sold, and further distribution is expressly prohibited. Except as authorized above, prior written permission must be obtained from Texas Instruments Incorporated to reproduce or transmit this work or portions thereof in any other form or by any other electronic or mechanical means, including any information storage or retrieval system, unless expressly permitted by federal copyright law. Send inquiries to this address:

Texas Instruments Incorporated
7800 Banner Drive, M/S 3918
Dallas, TX 75251

Attention: Manager, Business Services

Copyright © 1999, 2000, 2006 Texas Instruments Incorporated. Except for the specific rights granted herein, all rights are reserved.

Printed in the United States of America.

MultiView, MathPrint, Automatic Power Down, APD, and EOS are trademarks of Texas Instruments Incorporated.

Table of contents

CHAPTER	PAGE	CHAPTER	PAGE
About the teacher guide	v	How to use the TI-30XS MultiView calculator (Continued)	
About the TI-30XS MultiView™ calculator	vi	11 Statistics	83
Activities		12 Probability	89
Star voyage		13 Function table	97
Scientific notation	3	14 Powers, roots, and reciprocals	101
Heart rates		15 Logarithms and exponential functions	109
1-variable statistics	7	16 Pi	113
At the movies		17 Angle settings and conversions	117
Data formulas at the box office	13	18 Polar and rectangular conversions	121
Name that rule		19 Trigonometry	123
Algebraic expressions	21	20 Hyperbolics	131
How to use the TI-30XS MultiView calculator		Appendix A	
1 TI-30XS MultiView basic operations	29	Quick reference to keys	A-1
2 Clearing and correcting	41	Appendix B	
3 Basic math	45	Display indicators	B-1
4 Order of operations and parentheses	49	Appendix C	
5 Numeric notation	55	Error messages	C-1
6 Fractions	59	Appendix D	
7 Decimals and decimal places	65	Support and service information	D-1
8 Constant	67	Appendix E	
9 Memory and stored variables	71	Battery information	E-1
10 Data editor and list formulas	79		

About the teacher guide



How the teacher guide is organized

This guide is for the TI-30XS MultiView™ and TI-30XB MultiView scientific calculators. All subsequent references in this guide refer to the TI-30XS MultiView, but are also applicable for the TI-30XB MultiView.

This guide consists of two sections: **Activities** and **How to use the TI-30XS MultiView calculator**. The **Activities** section is a collection of activities for integrating the TI-30XS MultiView into mathematics instruction. The **How to use the TI-30XS MultiView calculator** section is designed to help you teach students how to use the calculator.

Each section uses the default settings, including the MathPrint™ mode, unless indicated otherwise.

Activities

Each activity is self-contained and includes the following:

- An overview of the mathematical purpose of the activity.
- The mathematical concepts being developed.
- The materials needed to perform the activity.
- The detailed procedure, including step-by-step TI-30XS MultiView key presses.
- A student activity sheet.

How to use the TI-30XS MultiView

This section contains examples on transparency masters. Chapters are numbered and include the following.

- An introductory page describing the calculator keys presented in the example, the location of those keys on the TI-30XS MultiView, and any pertinent notes about their functions.
- Transparency masters following the introductory page provide examples of practical applications of the key(s) being discussed. The key(s) being discussed are shown in black on the TI-30XS MultiView keyboard. The mode settings for the example are also shown.

Reset the TI-30XS MultiView

- You can ensure that everyone starts at the same point by having students reset the calculator: Press **on** and **clear** simultaneously or press **2nd** **[reset]** and then select **2** (Yes).

Conventions used in the teacher guide

- In the text, brackets [] around a key's symbol/name indicate that the key is a second, or alternate, function.

For example: **2nd**[sin⁻¹]

How to order additional teacher guides

To place an order or to request information about Texas Instruments (TI) calculators, use our e-mail address: ti-cares@ti.com, visit our home page: education.ti.com, or call our toll-free number:

1-800-TI-CARES (1-800-842-2737)



About the TI-30XS MultiView™ calculator

Home screen

On the Home screen, you can enter mathematical expressions and functions, along with other instructions. The answers are displayed on the Home screen. The TI-30XS MultiView screen can display a maximum of four lines with a maximum of 16 characters per line. For entries and expressions of more than 16 characters, you can scroll left and right (◀ and ▶) to view the entire entry or expression.

When you press **2nd**[quit], the TI-30XS MultiView calculator returns you to a blank Home screen. Press ◀ and ▶ to view and reuse previous entries. (See Previous Entries, page vii.)

In the MathPrint™ mode, you can enter up to four levels of consecutive nested functions and expressions, which include fractions, square roots, exponents with $^$, $\sqrt[x]{y}$, e^x , and 10^x .

When you calculate an entry on the Home screen, depending upon space, the answer is displayed either directly to the right of the entry or on the right side of the next line.

Display indicators

Refer to Appendix B for a list of the display indicators.

Order of operations

The TI-30XS MultiView uses the Equation Operating System (EOS™) to evaluate expressions. The operation priorities are listed on the transparency master in Chapter 4, Order of operations and parentheses.

Because operations inside parentheses are performed first, you can use **[]** to change the order of operations and, therefore, change the result.

Mode

Use **mode** to choose modes. Press ◀ ▶ ◀ ▶ to choose a mode, and **enter** to select it. Press **clear** or **2nd**[quit] to return to the Home screen and perform your work using the chosen mode settings. Default settings are shown.



Classic mode displays inputs and outputs in a single line.

MathPrint mode displays most inputs and outputs in textbook format. Use MathPrint mode for better visual confirmation that math expressions have been entered correctly and to better reinforce the correct math notation.

Note: Switching the mode between Classic and MathPrint clears calculator history and the Constant value.

2nd functions

Pressing **2nd** displays the **2nd** indicator, and then accesses the function printed above the next key pressed. For example, **2nd** [$\sqrt{}$] 25 **enter** calculates the square root of 25 and returns the result, **5**.



Menus

Certain keys display menus: **prb**, **2nd**[angle], **data**, **2nd**[stat], **2nd**[reset], **2nd**[recall], and **2nd**[clear var]. Press **↓** or **↑** to scroll and select a menu item, or press the corresponding number next to the menu item. To return to the previous screen without selecting the item, press **clear**. To exit a menu or application and return to the Home screen, press **2nd**[quit].

Previous entries **↔** **↓**

After an expression is evaluated, use **↔** and **↓** to scroll through previous entries, which are stored in the TI-30XS MultiView history. You can reuse a previous entry by pressing **enter** to paste it on the bottom line, and then editing and evaluating a new expression.

Answer toggle **↔**

The toggle key displays the last calculated result into different output formats, where possible. Press **↔** to toggle between fraction and decimal answers, exact square root and decimal, and exact pi and decimal.

Last answer (Ans)

The most recently calculated result is stored to the variable **Ans**. **Ans** is retained in memory, even after the TI-30XS MultiView is turned off. To recall the value of **Ans**:

- Press **2nd** [ans] (**Ans** displays on the screen), or
- Press any operation key (**+**, **-**, and so forth) as the first part of an entry. **Ans** and the operator are both displayed.

Resetting the TI-30XS MultiView

Pressing **on** and **clear** simultaneously or pressing **2nd** [reset] and then selecting **2** (Yes) resets the calculator.

Resetting the calculator:

- Returns settings to their defaults — standard notation (floating decimal) and degree (**DEG**) mode.
- Clears memory variables, pending operations, entries in history, statistical data, constants, and **Ans** (Last answer).

Note: The examples on the transparency masters assume all default settings.

Automatic Power Down™ (APD™)

If the TI-30XS MultiView remains inactive for about 5 minutes, the APD feature turns it off automatically. Press **on** to restore power. The display, pending operations, settings, and memory are retained.

Error messages

Refer to Appendix C for a listing of the error messages.

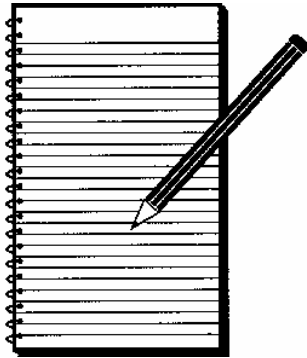

Activities

<i>Star Voyage</i> —	
<i>Scientific notation</i>	3
<i>Heart Rates</i> —	
<i>1-variable statistics</i>	7
<i>At the movies</i> —	
<i>Data formulas at the box office</i>	13
<i>Name that rule</i> —	
<i>Algebraic expressions</i>	21

Star voyage — scientific notation

Overview

Students investigate scientific notation by changing numbers into scientific notation, and then using them in calculations.

Math Concepts

- scientific notation
- addition
- division

Materials

- TI-30XS MultiView™
- pencil
- student activity

Introduction

Set up the activity by telling your students:

The standard form for scientific notation is $a \times 10^n$, where a is greater than or equal to 1 and less than 10, and n is an integer.

1. Have students practice writing the following numbers in scientific notation using pencil and paper.

- | | |
|----------------------|------------------------|
| a. 93 000 000 | 9.3×10^7 |
| b. 384 000 000 000 | 3.84×10^{11} |
| c. 0.000000000000234 | 2.34×10^{-12} |
| d. 0.0000000157 | 1.57×10^{-8} |

2. Have students change the following numbers into scientific notation (SCI) using the TI-30XS MultiView scientific calculator.

- | | |
|----------------|----------------------|
| a. 12 000 000 | 1.2×10^7 |
| b. 974 000 000 | 9.74×10^8 |
| c. 0.0000034 | 3.4×10^{-6} |
| d. 0.000000004 | 4×10^{-9} |

Note: Answers assume the default floating decimal setting.

3. Have students change the following numbers into standard (NORM) notation.

- | | |
|-------------------------|------------|
| a. 5.8×10^7 | 58 000 000 |
| b. 7.32×10^5 | 732 000 |
| c. 6.2×10^{-6} | 0.0000062 |
| d. 3×10^{-8} | 0.00000003 |

Note: To enter a negative number, press $(-)$ and then enter the number.

 Follow these steps:

1. Enter the first number, 12000000.
2. Press **mode**.
3. Press \leftarrow \rightarrow **enter** **clear** **enter** to display the number in scientific notation.

$1.2*10^7$

 Follow these steps:

1. Enter 5.8; press $\times 10^n$.
2. Enter 7; press **mode**.
3. Press \leftarrow **enter** **clear** **enter**.

58000000

Star voyage — scientific notation (Continued)

Activity

Present the following problem to students:

You are a captain of a starship in the distant future. You have been assigned to go to Alpha Centauri and you have 5 years to get there. The distance from our sun to Alpha Centauri is 2.5×10^{13} miles. The distance from the earth to our sun is approximately 9.3×10^7 miles.

Although we have not yet discovered how to travel at the speed of light, you live in a time where your ship can travel at the speed of light.

Light travels the approximate distance of 6×10^{12} miles in 1 light year. You will take a path from earth by our sun and then on to Alpha Centauri. Will you be able to get to Alpha Centauri on time?

Procedure

- Using the TI-30XS MultiView™ calculator, find the total distance you need to travel.

$$2.5 \times 10^{13} + 9.3 \times 10^7 = 2.5000093 \times 10^{13} \text{ miles}$$

- Next, find out how long it will take you to travel the distance. (Distance traveled \div 1 light year)

$$\frac{2.5000093 \times 10^{13}}{6 \times 10^{12}} = 4.1666821672 \text{ years}$$

- Can you make the trip in the allotted time of 5 years?

Yes, if your ship really could travel at the speed of light.

Extension

Light travels at 186,000 miles per second. A light year is the distance that light can travel in a year. Have students convert one light year to miles traveled per light year.

$$\frac{186,000 \text{ miles}}{1 \text{ sec}} \times \frac{60 \text{ sec}}{1 \text{ min}} \times \frac{60 \text{ min}}{1 \text{ hr}} \times \frac{24 \text{ hrs}}{1 \text{ day}} \times \frac{365 \text{ days}}{1 \text{ year}} \approx \frac{5.87 \times 10^{12} \text{ miles}}{1 \text{ year}}$$

We approximate this value using 6×10^{12} miles in 1 light year in this activity.

Answer to student extension: It will take the starship approximately 15 years to get to Delta Centauri.

Hint: Make sure the TI-30XS MultiView calculator is in MathPrint™ mode to work this problem.



Hint: The Earth is approximately 9.3×10^7 miles from the Sun.

Follow these steps:

- Press 2.5 $\boxed{\times 10^x}$ 13 $\boxed{\downarrow}$ $\boxed{+}$ 9.3 $\boxed{\times 10^x}$ 7 $\boxed{\text{enter}}$.

$$2.5000093 \times 10^{13}$$

- Press $\boxed{2\text{nd}}$ $\boxed{\text{ans}}$ $\boxed{\frac{\square}{\square}}$ 6 $\boxed{\times 10^x}$ 12 $\boxed{\text{enter}}$.

$$4.166682167$$

Depending on the problem, remind students to include parentheses where needed to ensure the intended order of operations.

Example:

$(2.5000093 \times 10^{13}) \div (6 \times 10^{12})$
must include the parentheses in order to get the correct result.

Students can learn more about this topic by visiting NASA web sites on the Internet.

Star voyage — scientific notation

Name _____

Date _____



Problems

1. Write the following numbers in scientific notation.

Standard Notation

Scientific Notation

a. 93 000 000

b. 384 000 000 000

c. 0.00000000000234

d. 0.0000000157

2. Using the TI-30XS MultiView™ calculator, change the following numbers into scientific notation using SCI mode.

Standard Notation

Scientific Notation

a. 12 000 000

b. 974 000 000

c. 0.0000034

d. 0.000000004

3. Using the TI-30XS MultiView calculator, change the following numbers into standard decimal notation using NORM mode.

Scientific Notation

Standard Notation

a. 5.8×10^7

b. 7.32×10^5

c. 6.2×10^{-6}

d. 3×10^{-8}

Star voyage — scientific notation

Name _____

Date _____



Problem

You are a captain of a starship in the distant future. You have been assigned to go to Alpha Centauri and you have 5 years to get there. The distance from our sun to Alpha Centauri is 2.5×10^{13} miles. The distance from the earth to our sun is approximately 9.3×10^7 miles.

Although we have not yet discovered how to travel at the speed of light, you live in a time where your ship can travel at the speed of light.

Light travels the approximate distance of 6×10^{12} miles in 1 light year. You will take a path from earth by our sun and then on to Alpha Centauri. Will you be able to get to Alpha Centauri on time?

Procedure

1. Using the TI-30XS MultiView™ calculator, find the total distance that you need to travel. For this rough estimate, assume that you are measuring the distance as a straight line from the earth to our sun and then on to Alpha Centauri.

Hint: Make sure your calculator is in scientific notation mode before you begin the calculation.

Next, find out how long it will take you to travel the distance.

(Distance traveled \div 1 light year)

Hint: Make sure you use parentheses if needed in order to get the correct result for this division problem.

2. Can you make the trip in the allotted time of 5 years?

Extension

Now that you have been successful, you have been asked to make another trip. The distance from the Sun to Delta Centauri is 9×10^{13} miles. How long will it take you to get there from Earth?

Hint: The Earth is approximately 9.3×10^7 miles from the Sun.

Your trip on this starship is fictitious. If you are interested in finding out more about the nearest star and cosmic distances, visit NASA web sites on the Internet.

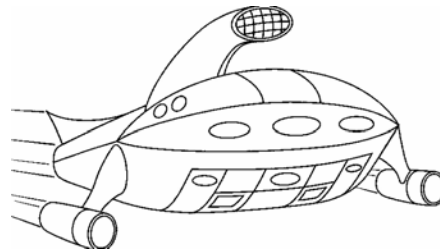

Heart rates — 1-variable statistics

Overview

Students use the data editor and statistics function of the TI-30XS MultiView™ calculator to investigate the effect of exercise on heart rate.

Math Concepts

- mean, minimum, maximum, and range

Materials

- TI-30XS MultiView
- stopwatch or a watch with a second hand
- student activity

Introduction

Students may be placed in smaller groups for this activity to minimize the amount of data to be entered. Ask students:

- *What do you think the average heart rate is for someone your age?*
- *What about after exercising?*

Activity

Have students complete the following investigation to check their estimations.

1. Have students check their resting heart rate by timing their pulse for 1 minute. (You could have them time for 10 seconds and then multiply by 6, but this could be the quietest minute of your day!)
2. Collect data on the chart. Enter each student's heart rate and a mark in the frequency column. As other students have the same heart rate, add another tally mark in the frequency column.
3. Enter the heart rate data into the TI-30XS MultiView scientific calculator.
 - a. Enter the first heart rate on the chart in L1, and the number of tallies for that heart rate in L2. You will use L2 as the frequency.
 - b. You must press \ominus between entries. For example, enter the first heart rate, and then press \ominus .
 - c. For example, assume a class of 22 students:

Rate	Students	Rate	Students
60	3	63	3
61	5	64	1
62	6	65	4

 Follow these steps:

1. Press **data** to enter the heart rates and frequencies. Enter the heart rates in L1 and the frequencies in L2. Press \ominus between entries, and \triangleright to get from L1 to L2.
2. Continue entering until you have entered all the heart rates and frequencies.
3. Press **2nd** [**stat**].
4. Press 1 to choose 1-var stats.
5. Choose L1 for the data, and L2 for the frequency.
6. Press \ominus **enter** to view the data.

Heart rates — 1-variable statistics (Cont.)

4. Check the statistics calculations. After students display Σx (Sigma x), explain that Σx is the sum of all the heart rates. Ask students:

- *How many heartbeats were entered from all of the student in one minute? This is Σx .*
- *How many students were entered? This is n .*
- *How can we calculate the average heart rate? This is \bar{x} . $\frac{\Sigma x}{n} = 62.27272727$*
- *Is the average heart rate higher or lower than you expected?*

5. Now we will see the effect of some exercise on heart rate. To accommodate various student's needs, pair students with other students who will be able to complete the task. Also consider designing some task that an individual student can safely undertake to raise their heart rate. Tell students:

If at any point during this portion of the activity you experience pain, weakness, or shortness of breath, stop immediately.

6. Have the students run in place for 2 minutes and then give them these instructions:

- Time your pulse for 1 minute.*
- Record your heart rate as before.*
- Enter the data into the calculator.*
- Compare the average heart rate after running with the resting heart rate.*

7. Now have the students do jumping jacks for 2 minutes. Instruct them to time their pulse for 1 minute again and record as before. Have them enter the data into the calculator again and calculate the average heart rate after jumping jacks. Compare to the other 2 averages.

8. Instruct students to make a bar graph of the 3 sets of data they collected. Ask students:

- *How are the bar graphs the same?*
- *How are they different?*
- *Is the data grouped the same, or is it more spread out in one graph compared to another?*

 Follow these steps:

1. View the statistical data.
n should equal the total number of students sampled. For this example, $n = 22$.
2. Press \odot to \bar{x} to see the average heart rate.
 $\bar{x} = 62.27272727$
3. Press \odot until you see Σx .
 $\Sigma x = 1370$

Note: The numbers show the results for the example described in this activity. Your students' results will vary depending on the size of the group and the heart rate readings.

Heart rates — 1-variable statistics

Name _____

Date _____



Problem

What do you think the average heart rate is for someone your age? What about after exercising?

Procedure

1. Use this table to record your class or group data (resting).

Heartbeats per minute (resting)	Frequency

2. What is the class (group) average? _____
3. Answer the following questions from the data:
 - a. What is the total number of heartbeats for the minute? Write the symbol and the number from the calculator. _____
 - b. What is the total number of student's heartbeats entered? Write the symbol and the number from the calculator. _____
 - c. How would you compute the average heart rate? _____
Is your answer the same as in question 2? _____

Heart rates — 1-variable statistics

Name _____

Date _____



4. Use this table to record your class or group data (running).

Heartbeats per minute (running)	Frequency

5. What is the class (group) average? _____

6. Answer the following questions from the data:

a. What is the total number of heartbeats for the minute? Write the symbol and the number from the calculator. _____

b. What is the total number of student's heartbeats entered? Write the symbol and the number from the calculator.

c. How would you compute the average heart rate?

Is your answer the same as in question 5? _____



Heart rates — 1-variable statistics

Name _____

Date _____



7. Use this table to record your class or group data (jumping).

Heartbeats per minute (jumping)	Frequency

8. What is the class (group) average? _____

9. What is the total number of heartbeats for the minute? _____

10. Answer the following questions from the data:

- What is the total number of heartbeats for the minute? Write the symbol and the number from the calculator. _____
- What is the total number of student's heartbeats entered? Write the symbol and the number from the calculator. _____
- How would you compute the average heart rate? _____
Is your answer the same as in question 8? _____

Heart rates — 1-variable statistics

Name _____

Date _____



11. Make a bar graph for each of the 3 sets of data you collected.

Resting

Running

Jumping

12. How are the bar graphs the same? How are they different? _____

13. Is the data grouped the same or is it more spread out in one graph compared to another? _____

At the movies — data formulas at the box office

Overview

Students investigate a table of values and observe patterns in the table. Students use **data** on the TI-30XS MultiView™ calculator to enter data into a list and test their generalizations.

Math Concepts

- patterns
- algebraic expressions
- linear functions
- variables

Materials

- TI-30XS MultiView
- pencil
- graph paper
- student activity

Introduction

The warm up question is given to help you launch the student sheet activity. You can skip the warm up activity but you will have to provide more guidance during the investigation of the problem on the student sheet.

Warm up

Guide students in the use of tables and **data** to see a pattern and write a generalization. Present the following story problem.

Every Wednesday, Keisha gets home from work too late to walk her dog, Max. She asked her neighbor Kyle to walk her dog after he comes home from school. Kyle is happy to help! Keisha pays Kyle \$4 each week to walk Max. Kyle likes to save his money. Create a table of how much money Kyle has each week for 5 weeks.

Guide students to create the following table on their papers. You can think of this table as a data list of two numbers which depend on each other. It is important to have students write their calculation and outcome in the Money (output) column in order to see any patterns. This helps them to write algebraic sentences from the words and to make generalizations using inductive reasoning.

Use these columns for different learning styles if needed.

Week	Money
1	$1 \times 4 = 4$
2	$2 \times 4 = 8$
3	$3 \times 4 = 12$
4	$4 \times 4 = 16$
5	$5 \times 4 = 20$

Repeated addition	Adding on
$4 = 4$	$4 = 4$
$4 + 4 = 8$	$4 + 4 = 8$
$4 + 4 + 4 = 12$	$8 + 4 = 12$
$4 + 4 + 4 + 4 = 16$	$12 + 4 = 16$
$4 + 4 + 4 + 4 + 4 = 20$	$16 + 4 = 20$

At the movies (Continued)

Point out that the Money column looks like the multiplication table for the number 4. This connects them back to something familiar. Remind the students that they know that Kyle earns \$4 per week. This is the rate of Kyle's savings and it can be written in fractional form as

$$\text{rate} = \frac{\$4}{1 \text{ week}}$$

Ask the students to fill in more of the table describing how much Kyle will save. Have them fill in the table for weeks 6 and 7, and then ask if they can determine the amount of money for 10 weeks, 25 weeks, and 100 weeks. Finally, ask them if they could fill in the amount of money after some number of weeks. Call the unknown number of weeks a variable and use the letter W to represent weeks. Use the variable M to represent money.

Week (W)	Money (M)
1	1x4=4
2	2x4=8
3	3x4=12
4	4x4=16
5	5x4=20
6	6x4=24
7	7x4=28
10	10x4=40
25	25x4=100
W	Wx4*

All of this investigation should be done *without* the calculator for these basic multiplication facts. If students need support with their multiplication, encourage looking up facts in a chart rather than using the calculator, to promote mental math and appropriate calculator use.

Ask students to write the expression for the calculation using W, x, and 4.*

(Answer: W x 4)

At the movies (Continued)

Ask the students the following:

"If you calculate W weeks times \$4, you get a number. What does that number mean to Kyle?" You are prompting the student to say Money (M) and lead them into writing the formula or sentence in two variables, $M = W \times 4$. Typically, you write the number and then the letter with implied multiplication. Remind students that multiplication is commutative so $M = W \times 4 = 4 \times W = 4W$.

Support the investigation using the data editor (**data**) on the TI-30XS MultiView™ calculator by having the students look at many values of their algebraic expression to see if they match the table they created.

1. Have students enter their table into the data list. Notice there are three lists available: L1, L2, and L3.

Discuss that they will enter the Week (W) values in L1.

2. Have the students enter the first three values of W from their table, {1, 2, 3}.
3. Enter a formula to validate the work: $L2 = 4 \times L1$. Notice that $W = L1$ and $M = L2$.
4. Add input to L1 to see L2 update automatically with the output value of the formula. Scroll to an open entry space in L1. Ask them to check their table for 4 weeks and then 100 weeks.

Before starting the group investigation on the student sheet, have the students clear the data in the lists.

(Continued)

 Remind students that for this activity they are using the features in **data** and not **table**.

 If students are not familiar with the TI-30XS MultiView calculator, have them turn on the calculator and press **mode**.

 Make sure all students have their calculator mode set as shown:

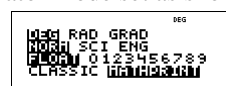

To return to the Home screen, press **clear**.

1. Enter the first three values of W :
data 1 \downarrow 2 \downarrow 3 \downarrow .

2. Enter the formula:

\downarrow **data** \downarrow 1

4 \times **data** 1 **enter**.

3. Add input to L1:

\downarrow \downarrow \downarrow \downarrow 4 **enter**

100 **enter**.

4. To view the formula in L2 again, press \downarrow **data** \downarrow 1.

5. Edit the formula, if desired, and press **enter** to set the formula again.

6. To clear data, press **data** 4.

 Hint: Remember that pressing **2nd**[quit] takes you back to the Home screen.

At the movies (Continued)

The students now have taken data from words to a table of values, to a pattern they can view, to writing an algebraic expression. The next step is to show them a view of how the number pattern plots on a graph. What is the shape of $M = 4W$? Have students plot the first 4 points in the table. Notice the points fall on a straight line. You can mention that they can describe the increase of Money (M) as "for every 1 week (W) Kyle works, his amount of money (M) increases by \$4." This is an obvious statement but sets the foundation for talking about rates and how they affect the tilt of a line (slope).

The number of weeks and amount of money are both positive so the graph makes sense in the first quadrant. Have your students use graph paper to make the graphs of their data.

Activity

Students repeat a similar investigation in groups looking at patterns to write algebraic expressions and sentences. They also create a graph of the values in the table. Have students read the problem on the student sheet before breaking up into groups so they understand their task.

Students fill in the table using mental math. They write all calculations to help them see the formula. They are encouraged to use mental math as much as they can *before* using the calculator to find the results for the amount of money.

Number of People (P)	Calculation	Amount of Money (M)
1	1×11.50	\$11.50
2	2×11.50	\$23.00
3	3×11.50	\$34.50
4	4×11.50	\$46.00
...		
10	10×11.50	\$115.00
...		
100	100×11.50	\$1150.00
...		
1000	1000×11.50	\$11500.00
...		
P	$P \times 11.50$	$M = P \times 11.50$

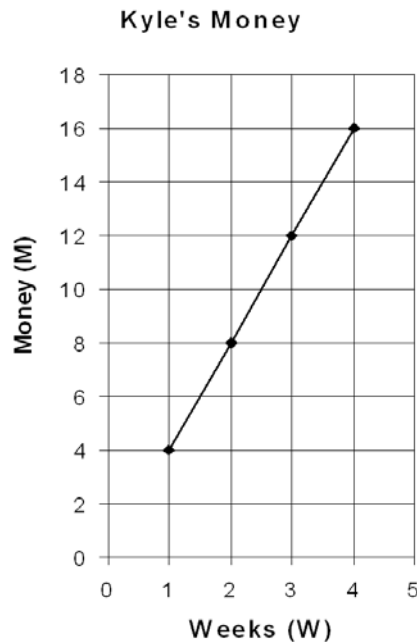

At the movies (Continued)

Procedure

Students should write the algebraic equation from the pattern showing in their table: $M = P \times 11.50$ or using implicit multiplication, $M = 11.50 P$.

Students check their formula using the data editor (**data**) on the TI-30XS MultiView™ calculator, as in the warm up example.

1. Have the students check to see how the calculator is set up.
2. Enter the first three values in L1 {1, 2, 3}.
3. Translate your formula to the calculator formula and enter the formula into L2.

Your formula: $M =$ _____

The calculator formula: L2 = _____

4. Enter more values into L1 to check the table of values and the formula. This activity validates the formula for several values.
5. Enter 7500 in L1 to find the amount of money in L2. Write the math as $M = 11.50 \times 7500 = \$86,250$.
6. Create a report by filling in a table of values and a graph. Write a paragraph describing the work for the presentation.

Answers in the paragraph will vary. Make sure that the students explain the table, graph, and algebraic sentence (formula) in the paragraph.

P	M
500	\$5750
1000	\$11500
1500	\$17250
2000	\$23000
2500	\$28750

1. Make sure the calculator mode is set as shown.

1. Press **mode**.



2. Press **data** 1 **↵** 2 **↵** 3 **↵**.

3. Enter the formula in L2.

data 1
11 **÷** 50 **×** **data** 1 **enter**.

4. Press **↵** **↵** **↵** 4 **enter**
5 **enter** 6 **enter** 10 **enter**
100 **enter** 1000 **enter**.

5. Press 7500 **enter**.

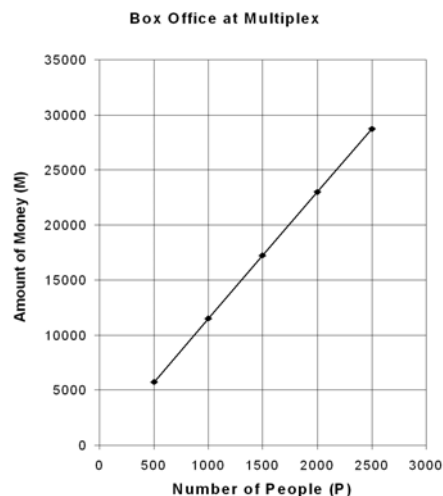

At the movies

Name _____

Date _____



Problem

A blockbuster movie is opening this weekend. On the news, you hear that tickets will be \$11.50 per person. The reporter says that a family of two will spend \$23 and a family of three will spend \$34.50. They show a graphic with this information in a table format.

Number of People	Amount of Money
1	\$11.50
2	\$23.00
3	\$34.50

The reporter also mentions that the local theater, MultiPlex, has twenty-five screens and can seat 7,500 people. This blockbuster will open on all screens at the theater. The owners predict that all seats will be sold out on the first day!

The owners of MultiPlex want to know how much money they can expect to take in at the ticket office. They would like a general formula so they can quickly find out the amount of money for any amount of people that buy tickets.

Your job: You have been hired as the accountant for MultiPlex! Congratulations! Your boss wants a formula that will tell her how much money will be taken in at the box office, depending on how many people buy tickets.

Procedure

1. Use the table to investigate the amount of money taken in at the ticket office depending on the number of people going to the movie. Fill in the following table. Write all of your calculations at each step. Use mental math as much as you can *before* using the calculator to find the results for the amount of money.

Number of People (P)	Calculation	Amount of Money (M)
1	1×11.50	\$11.50
2	2×11.50	\$23.00
3	3×11.50	\$34.50
4		
5		
6		
...		
10		
...		
100		
...		
1000		
...		

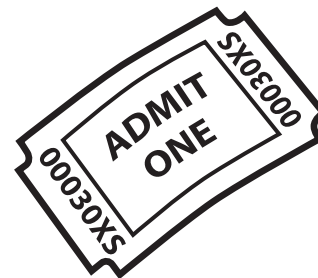

At the movies

Name _____

Date _____



2. What pattern do you see from your table? Using the information in your table, write a formula (an algebraic expression) which describes the amount of money (M) depending on the number of people (P) that buy a ticket to the show.

M = _____

3. Check your formula using the data list editor (**data**) on the TI-30XS MultiView™ calculator.
- In column L1, enter only the first three entries in the number of people (P) list from the table above. (Enter {1, 2, 3}.)
 - Enter your formula from part 2 in L2. Be careful: to use the calculator, you have to translate your variables (letters). The letter P is now L1 and M is L2. Rewrite your formula here in terms of L1 and L2 so you can enter the formula in your calculator.
Your formula: M = _____
The calculator formula: L2 = _____
 - Check the numbers in L2 with the numbers in your table above. Do they match?
 - Enter more values from the number of people list from your table into L1. Check the values in L2 against your table above. Do they match? Does your formula work?

4. Use the data editor on the calculator to find the amount of money (M) that the owners will take in at the ticket office if the entire theater is filled during one showing with 7500 people (P). Write how you would find this answer by hand using your formula.

At the movies

Name _____

Date _____



5. Your boss wants you to make a presentation to the people who invest money in MultiPlex. The investors want to see numbers and graphs in your presentation! Fill in the table below using the data editor on your calculator. Graph the points from this table. This is another way that an accountant can show how the amount of money (M) depends on the number of people (P). This gives a picture of the data!

P	M
500	
1000	
1500	
2000	
2500	

Amount of Money (M)

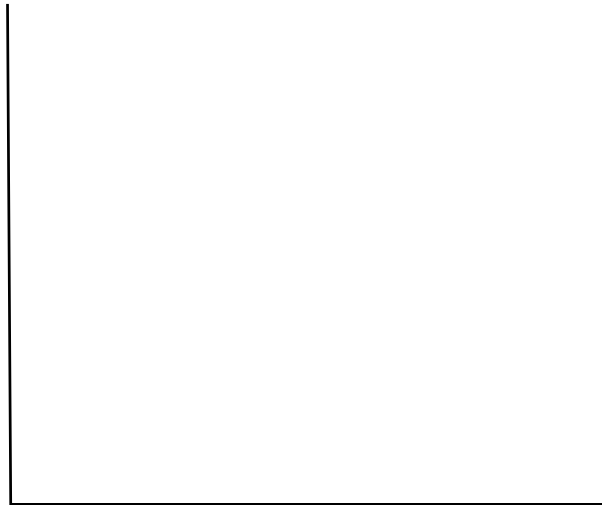

Number of People (P)

6. Write a paragraph below about what you would say to your boss and the investors about your work. Include how you determined the formula for the amount of money and what the table and graph tell them about the amount of money that will be taken in at the box office.

Name that rule!

Overview

Students guess the algebraic expression (function) from a table of values in a game format. Students use **table** on the TI-30XS MultiView™ calculator to enter an expression as a function ($y=$) in order to play the game.

Math Concepts

- algebraic expressions
- functions

Materials

- TI-30XS MultiView
- pencil
- student activity
- strips of paper and paper bag

Introduction

Students will warm up for this activity by evaluating expressions and filling out a table of values. They then play a game, "Name that rule!" The game uses the TI-30XS MultiView calculator to create a table of values.

Have students fill out the following tables which appear on the student sheet.

Note: Consider varying the variable letter in the warm up. The variable on the calculator, however, will always be x .

x	$x + 3$
-2	1
-1	2
0	3
1	4
2	5

x	$2x + 6$	$2(x + 3)^*$
-2	2	2
-1	4	4
0	6	6
1	8	8
2	10	10

*The students should notice that the tables for $2x + 6$ and $2(x + 3)$ are the same. Discuss why these are equivalent expressions and verify this by using the Distributive Property of Multiplication over Addition. You can also have students use tiles to display the area model, $2(x + 3) = 2x + 6$.

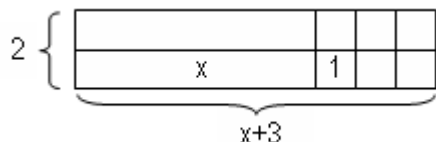

Show the students how to enter the expression in **table** on the TI-30XS MultiView. They enter the expression as a function. This may be a new concept for your students. If needed, use a function machine

Name that rule! (Continued)

to provide an alternate way of thinking about evaluating an expression for different values of x . Here, an input of $x = 1$ gives an output of $y = 1 + 3 = 4$. Discuss that the expression, $x + 3$, can be thought of as the rule to find y . Later in the game, the students will think backwards to guess the "rule." If needed, discuss how students follow the rules to their favorite board games. They need to follow the rules in order to play. When they evaluate an expression, they follow a rule to change one number to another.

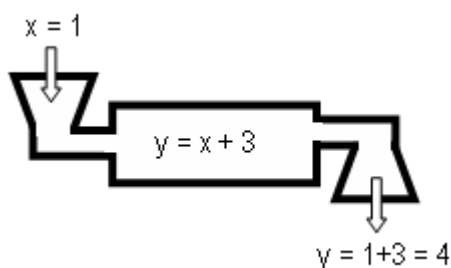

Set up the table on the calculator using the Auto feature in **table**. Auto automatically sets up a table of values to start at a given value and increment by a value. To have the calculator create the same table of values as above, set start at -2 and increment the x values by the step size of 1. Have students compare their table done by hand against the calculator table.

Activity

Play one or two games of "Name that rule!" with the whole class, using the rules on the next page. For the whole class introduction of the game, the teacher plays the role of the Ruler. This game uses **table** and the Ask- x feature on the TI-30XS MultiView™ calculator.

Follow these steps:

1. Press **mode** and set mode as shown.

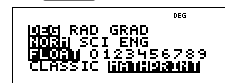

2. Enter the expression $y = x + 3$:
table $x^y \div$ **+** 3 **enter**.
3. Enter table setup values: **(-)** 2 **↵**
↵ **↵** **enter**.
4. Use **↵** and **↵** to scroll through values of x and $y = x + 3$.

Hint: Copy the game sheets from the student activity section for as many games as needed.

Name that rule! (Continued)

Rules for group play

- Form groups of three to four students.
- Assign one student to be the Ruler of the game.
- The Ruler is in charge of the calculator for the game.
- The Ruler picks an algebraic expression from a paper bag (or any container) and keeps it hidden from the other players, or the Ruler writes an algebraic expression on a piece of paper for the game and gets approval to use the expression from the teacher.

- The Ruler enters the algebraic expression into **table** and selects the Ask- x feature.

Note: The Ruler may have to delete each line in the Ask- x table before playing a new rule. (See keystroke instructions.)

- Each player other than the Ruler takes turns saying a value for x . The Ruler enters that value and tells the players the y value output.
- Each player keeps a table of values as a record of play.
- A player can guess the expression or rule only during the player's turn.
- Once a rule is guessed by a player, every player must check if the rule is true for all values already played, or challenge the rule by trying to find a value that does not work.
- If the guessed rule is shown to be incorrect by a player or the Ruler, the player who guessed the rule loses his or her next turn.
- If the algebraic expression guessed by a player is not in the same form as the expression entered by the Ruler, for example, $2(x+1)$ and $2x+2$, and all players agree that the guessed expression is correct, the Ruler reveals the expression on the calculator and the player who guessed the rule must explain why the two expressions are the same.
- The first player to guess the rule correctly and defend their rule wins.
- The role of Ruler then rotates to another player for the next round of play.

 Follow these steps:

1. Press **mode** and set mode as shown.

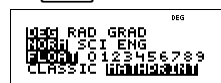

2. Enter the function $y = 2x + 5$:
clear **table** 2 **x²/_{abc}** + 5 **enter**.

Note: If a function is already entered on the $y=$ screen, press **clear** before entering a new function.

3. Enter table setup values: **enter** **enter**.
4. Enter x -values: 5 **enter** 6 **enter** 10 **enter**.

 **Hint:** To enter more values, highlight any of the three lines in the x column, enter the number, and press **enter**.

5. To review the $y=$ screen, press **table**. You will have to cycle through the setup screen again to see the table of values.

 To play again:

1. Clear the old expression, pick the next expression, and enter it:
table **clear** **x²/_{abc}** + **1** **1** **enter**.
2. Enter the desired table setup values, highlight **OK**, and press **enter**.
Notice that only 3 guesses show on the screen. Students can overwrite a number to see a new output.

Name that rule! (Continued)

Algebraic expression list

Copy these or other expressions on pieces of paper so the Ruler of each team of players can pick the expression to play. You can also have the Ruler write an expression which you can approve before the start of a game. Having the student write an expression gives them ownership and is an assessment of their knowledge.

Pick a list or mix the lists depending on the level of your students. Expand the lists depending on your students' level. Students should document all work on their student sheet.

Examples of
one-step expressions

$$x + 3$$

$$x - 9$$

$$x + \frac{1}{2}$$

$$x - 2.5$$

$$x + 15$$

$$x - \frac{1}{5}$$

Examples of
two-step expressions

$$2x + 3$$

$$-4x + 5$$

$$2x + 6 \text{ or } 2(x + 3)$$

$$\frac{1}{2}x - 4$$

$$1.5x + 2.5$$

Modifications of the game

- Include expressions that would need to be simplified by the players such as $2x + 4 + 3x - 6$. If a player guesses $5x - 2$, they will have to justify the expression is equivalent to $2x + 4 + 3x - 6$ which adds another assessment layer to the game.
- Include expressions in words such as "four less than twice a number." Have the Rulers pick the expression from the container and change the words to an expression for your approval before they return to their group to play the game.

Example: Four less than twice a number is picked. The Ruler translates this to $2x - 4$, you indicate if they are correct, and then they return to their group to play.

Name that rule!

Name _____

Date _____



Problem

We follow rules every day. Can you follow the rules to your favorite board game? Do you have to carefully follow the rules to play? We also follow rules when we work with numbers and expressions.

Example: If $x = 1$, then $x + 3 = 1 + 3 = 4$

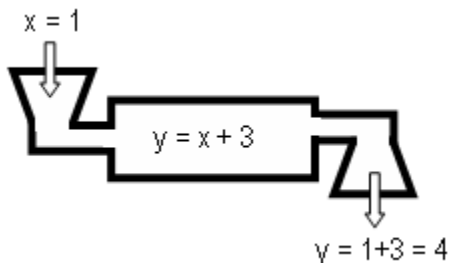

The expression $x + 3$ has one variable, x . Depending on the value of x , $x + 3$ will be equal to different numbers. You can think of $x + 3$ as a rule. Fill out the following table to warm up. The values of x have been picked for you.

x	$x + 3$
-2	
-1	
0	
1	
2	

x	$2x + 6$
-2	
-1	
0	
1	
2	

x	$2(x + 3)$
-2	
-1	
0	
1	
2	

1. What do you notice about the table for $2x + 6$ and $2(x + 3)$?
2. Check the tables above using **table** on the TI-30XS MultiView™ calculator.
3. Play the game "Name that rule!", using the game sheet on the next page. In this game, you will not know the expression (rule). You will have to guess the rule by thinking backwards! Your teacher will give you the instructions to play.



Name That Rule!



Think backwards!



Guess the rule from a table of values!

Player names:

Ruler:

Your teacher will give you the instructions on how to play. Use the table to keep track of the x and y values for every player's turn during the game. Use the Guess columns to check the rule. If a player's rule is not correct, continue playing.

x	Calculator y value	Guess 1 $y =$ _____ Check every x value! Is this guess correct? _____	Guess 2 $y =$ _____ Check every x value! Is this guess correct? _____
x	Calculator y value	Guess 3 $y =$ _____ Check every x value! Is this guess correct? _____	Guess 4 $y =$ _____ Check every x value! Is this guess correct? _____

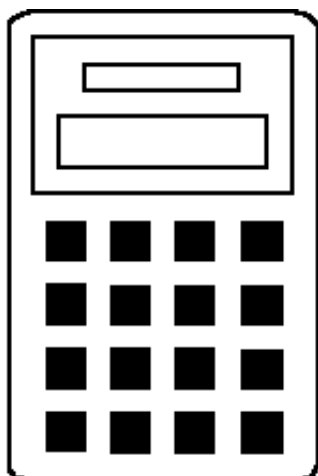

How to use the TI-30XS MultiView™ calculator

TI-30XS MultiView basic operations	29
Clearing and correcting	41
Basic math	45
Order of operations and parentheses	49
Numeric notation	55
Fractions	59
Decimals and decimal places	65
Constant	67
Memory and stored variables	71
Data editor and list formulas	79
Statistics	83
Probability	89
Function table	97
Powers, roots, and reciprocals	101
Logarithms and exponential functions	109
Pi	113
Angle settings and conversions	117
Polar and rectangular conversions	121
Trigonometry	123
Hyperbolics	131

TI-30XS MultiView™ basic operations

1

Keys



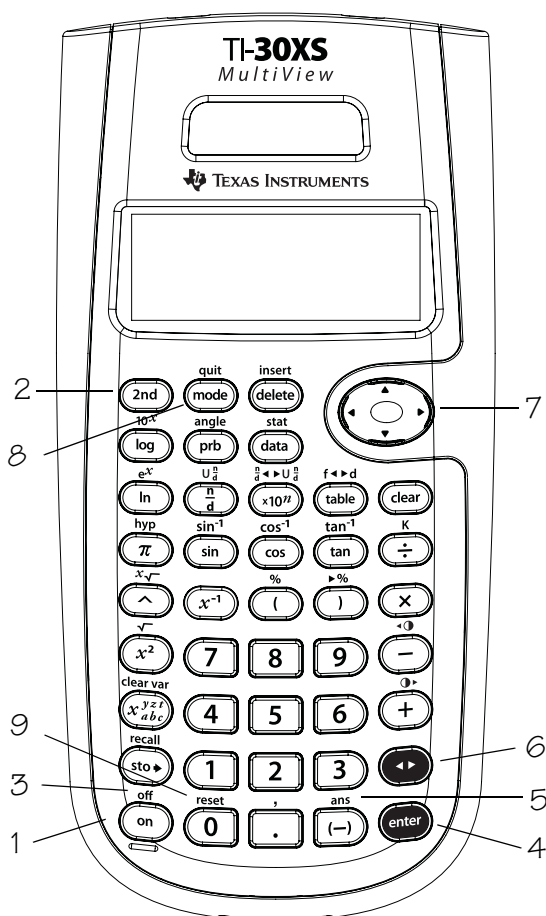





1. **[on]** turns on the calculator.
2. **[2nd]** turns on the **2nd** indicator and accesses the function shown above the next key you press.
3. **[2nd] [off]** turns off the calculator and clears the display.
4. **[enter]** completes the operation or executes the command.
5. **[2nd] [ans]** recalls the most recently calculated result and displays it as **Ans**.
6. **[\leftarrow]** toggles the answer between fraction and decimal, exact square root and decimal, and exact pi and decimal formats.



7. **[\leftarrow]** and **[\rightarrow]** move the cursor left and right to scroll entries on the Home screen and to navigate in menus.
[2nd] [\leftarrow] or **[2nd] [\rightarrow]** scrolls to the beginning or end of a current entry.
[\uparrow] and **[\downarrow]** move the cursor up and down through menu items, previous entries on the Home screen, and entries in Data editor and Function table.
[2nd] [\uparrow] moves the cursor to the top entry of the active column in Data editor, or to the previous entry on the Home screen. Press **[2nd] [\uparrow]** again to move the cursor to the oldest entry on the Home screen.
 In fractions, press **[2nd] [\uparrow]** to paste a previous entry to the denominator. (See Chapter 6, Fractions, for more information.)
[2nd] [\downarrow] moves the cursor to the first blank row of the active column in Data editor, or below the last entry on the Home screen.
 8. **[mode]** lets you set the angle, numeric, decimal, and display modes. Press **[\downarrow]** **[\uparrow]** **[\leftarrow]** **[\rightarrow]** to choose a mode, and **[enter]** to select it. Press **[clear]** or **[2nd] [quit]** to exit the mode menu.
 9. **[2nd] [reset]** displays the **Reset** menu.
 - Press **1** (No) to return to the previous screen without resetting the calculator.
 - Press **2** (Yes) to reset the calculator. The message **MEMORY CLEARED** is displayed.
- Note:** Pressing **[on]** and **[clear]** simultaneously resets the calculator immediately. No menu or message is displayed.
- Resetting the calculator:
 - Returns settings to their defaults: degree (**DEG**) angle mode, normal numeric notation (**NORM**), floating decimal notation (**FLOAT**) and MathPrint™ display mode.
 - Clears memory variables, pending operations, entries in history, statistical data, constants, and **Ans** (Last answer).

TI-30XS MultiView™ basic operations (Continued)

Notes

- The examples on the transparency masters assume all default settings (See page vi).
-  can be used in an entry before pressing . Pressing  more than once in a current entry may result in a Syntax error. To achieve the desired result, you can:
 - Enter the expression, press  , and then press  again after the result is displayed.
 - Enter the expression and press , and then press  as many times as desired to toggle the display and view the alternate format of the answer.
- When ◀ or ▶ appears in the display, the entry line contains more characters to the left or right.
- Press  after the Automatic Power Down™ (APD™) feature activates to restore power. The display, pending operations, settings, and memory are retained.

Second, off, arrows, enter

- Enter $46 - 23$.
- Change 46 to 41. Change 23 to 26 and complete the operation.
- Enter $2/5 + 3/10$ and complete the operation.
- Turn the TI-30XS MultiView™ calculator off and back on. The Home screen is blank; scroll up to view history.

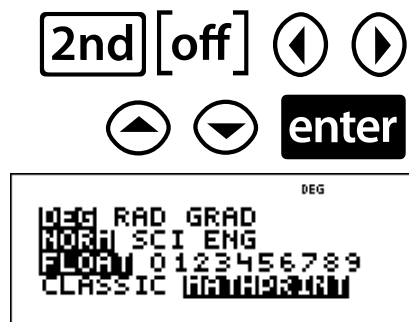

Press	Display
46 \ominus 23 enter	46-23 DEG ↑ 23
\uparrow \uparrow enter \downarrow \downarrow \downarrow \downarrow 1 \downarrow \downarrow 6 enter	46-23 DEG ↑↑ 23 41-26 15
2 $\frac{n}{d}$ 5 \rightarrow + 3 $\frac{n}{d}$ 10 enter	46-23 DEG ↑↑ 23 41-26 15 $\frac{2}{5} + \frac{3}{10}$ 7/10
2nd [off] on \uparrow \uparrow \uparrow	DEG ↑ █
	41-26 DEG ↑↑ 15 $\frac{2}{5} + \frac{3}{10}$ 7/10

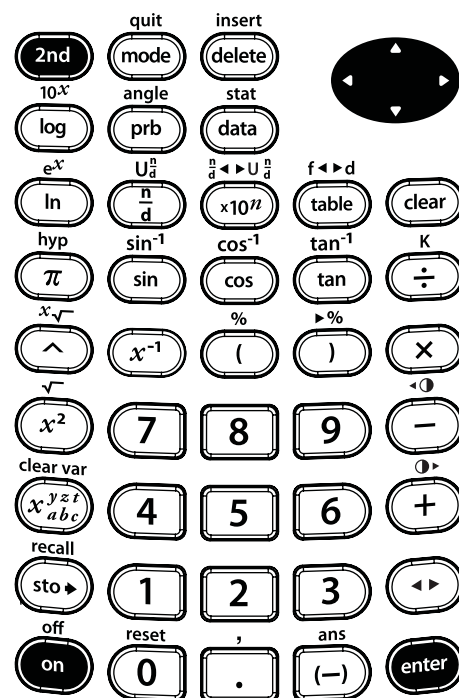

Reset

Reset the calculator.

2nd **[reset]**

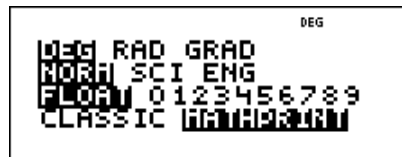

Press

Display

2nd **[reset]**

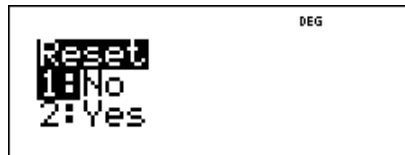

2

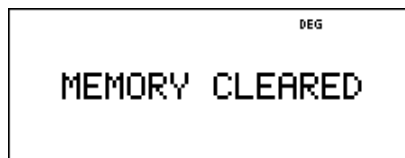

clear

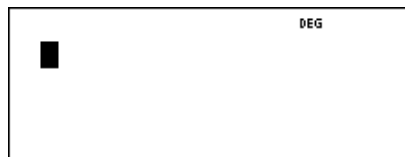

Pressing **on** and **clear** at the same time also resets the calculator immediately. No menu or message is displayed.

Using **2nd** **[reset]** or **on** and **clear** returns all settings to their defaults and clears the memory.

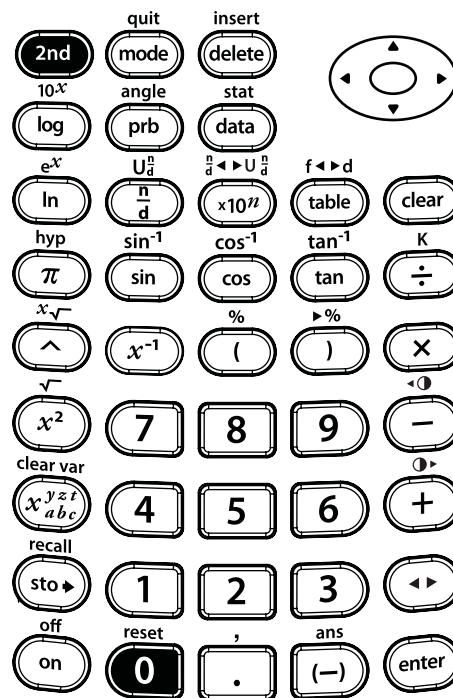

Mode

mode

Use **mode** to choose modes. Press  to choose a mode, and **enter** to select it. Press **clear** or **2nd** **[quit]** to return to the Home screen and perform your work using the chosen mode settings.

Default mode settings are shown highlighted.

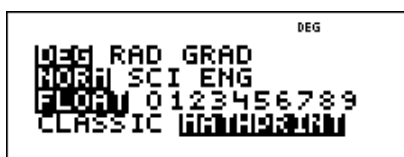

DEG RAD GRAD Sets the angle mode to degrees, radians, or gradians.

NORM SCI ENG Sets the numeric notation mode. Numeric notation modes affect only the display of results, and not the accuracy of the values stored in the calculator, which remain maximal.

mode

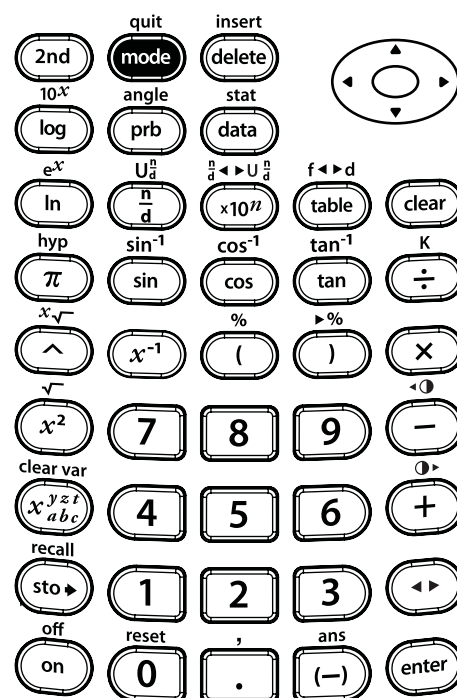

Mode (continued)

NORM displays results with digits to the left and right of the decimal, as in 123456.78.

SCI expresses numbers with one digit to the left of the decimal and the appropriate power of 10, as in 1.2345678×10^5 (which is the same as 123456.78).

ENG displays results as a number from 1 to 1000 times 10 to an integer power. The integer power is always a multiple of 3.

Note: $\boxed{\times 10^n}$ is a shortcut key to enter a number in scientific notation format. The result displays in the numeric notation format set in mode.

FLOAT **0 1 2 3 4 5 6 7 8 9**

Sets the decimal notation mode.

FLOAT (floating decimal point) displays up to 10 digits, plus the sign and decimal.

mode

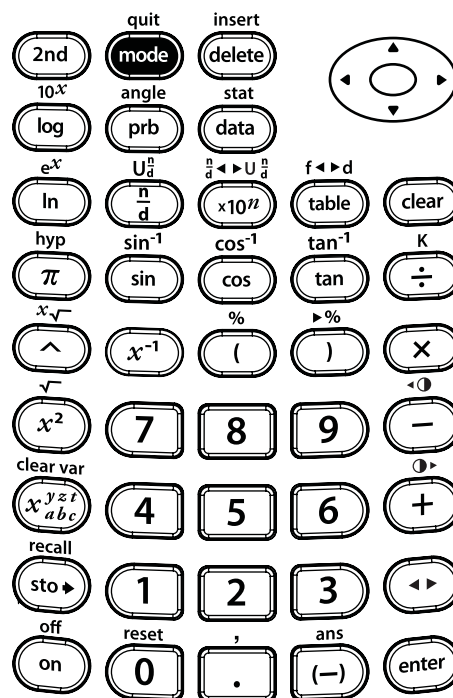

Mode (continued)

0 1 2 3 4 5 6 7 8 9 (fixed decimal point) specifies the number of digits (0 through 9) to display to the right of the decimal.

CLASSIC **MATHPRINT** sets the display input and output.

CLASSIC displays inputs and outputs in a single line.

MATHPRINT displays most inputs and outputs in textbook format. Use MathPrint mode for better visual confirmation that math expressions have been entered correctly and to better reinforce the correct math notation.

Note: Switching the mode between Classic and MathPrint clears calculator history and the Constant value.

mode

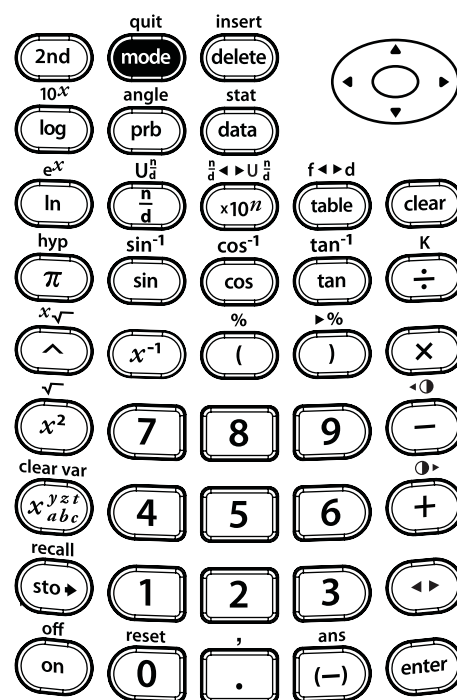

Menus

Certain keys display menus: **prb**, **2nd**[angle], **data**, **2nd**[stat], **2nd**[reset], **2nd**[recall], and **2nd**[clear var]. Some keys may display more than one menu.

Press **▶** and **▼** to scroll and select a menu item, or press the corresponding number next to the menu item. To return to the previous screen without selecting the item, press **clear**. To exit a menu or application and return to the Home screen, press **2nd**[quit]. The Home screen is blank; scroll up to view history.

Some sample menus:

prb		2nd [angle]	
PRB	RAND	DMS	R↔P
1: nPr	1: rand	1: °	1: R▶Pr(
2: nCr	2: randint(2: '	2: R▶Pθ(
3: !		3: "	3: P▶Rx(
		4: r	4: P▶Ry(
		5: g	
		6: ▶DMS	

Menus (Continued)

data

(Press **data** once to display the Data editor screen. Press again to display the menu.)

CLEAR

- 1: Clear L1
- 2: Clear L2
- 3: Clear L3
- 4: Clear ALL

FORMULA

- 1: Add/Edit Frmla
- 2: Clear L1 Frmla
- 3: Clear L2 Frmla
- 4: Clear L3 Frmla
- 5: Clear ALL

Press **data** while you are in the Add/Edit Frmla option of the FORMULA menu to display this menu:

LS

- 1: L1
- 2: L2
- 3: L3

2nd **[stat]**

STATS

- 1: 1-Var Stats
- 2: 2-Var Stats

3: StatVars

This menu option displays after you calculate 1-var or 2-var stats.

StatVars menu:

- 1: n
- 2: \bar{x}
- 3: S_x

Etc. See Chapter 11, Statistics, for a full list.

Last answer (Ans)

Use Last answer (Ans) to calculate

$$\sqrt{5^2 + 12^2}$$

Press

Display

5 x^2 + 12

x^2 enter

5²+12² 169

2nd $\sqrt{}$ 2nd

[ans] enter

5²+12² 169
 $\sqrt{\text{Ans}}$ 13

2nd [ans]





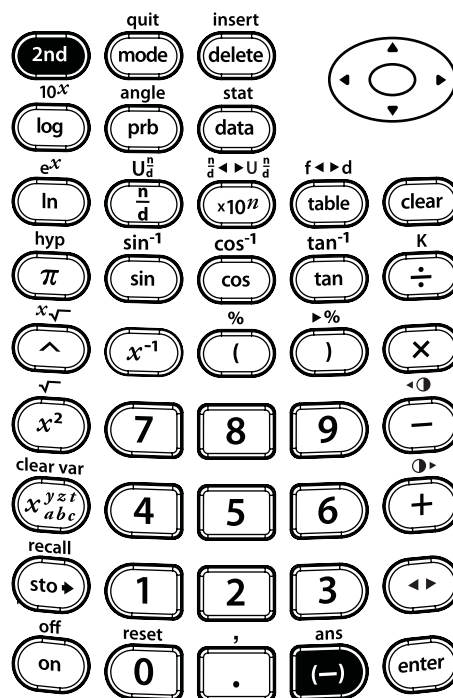

```

DEG RAD GRAD
NORM SCI ENG
FLOAT 0 1 2 3 4 5 6 7 8 9
CLASSIC MATHWDRN
    
```



Answer toggle

Press  to toggle the display result between fraction and decimal answers, exact square root and decimal, and exact pi and decimal.

Press	Display
   	
	

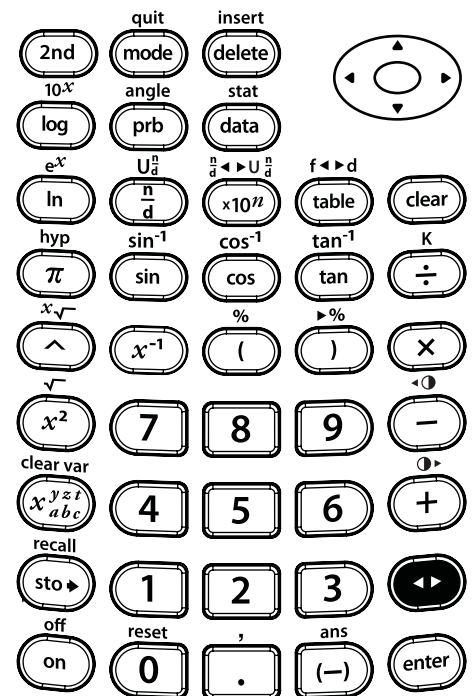
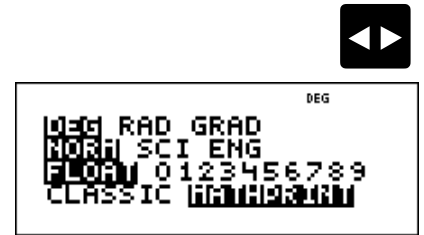

Clearing and correcting

2

Keys

1. **clear** clears characters and error messages. Press **clear** once to clear an uncompleted entry; press it again to clear the display. You can scroll up and use **clear** to clear entries in history. **clear** backs up one screen in applications.
2. **2nd** **insert** lets you insert a character at the cursor.
3. **delete** deletes the character at the cursor. Then, each time you press **delete**, it deletes 1 character to the left of the cursor.

Notes

- The examples on the transparency masters assume all default settings.
- Pressing **clear** does not affect the memory, statistical registers, angle units, or numeric notation.

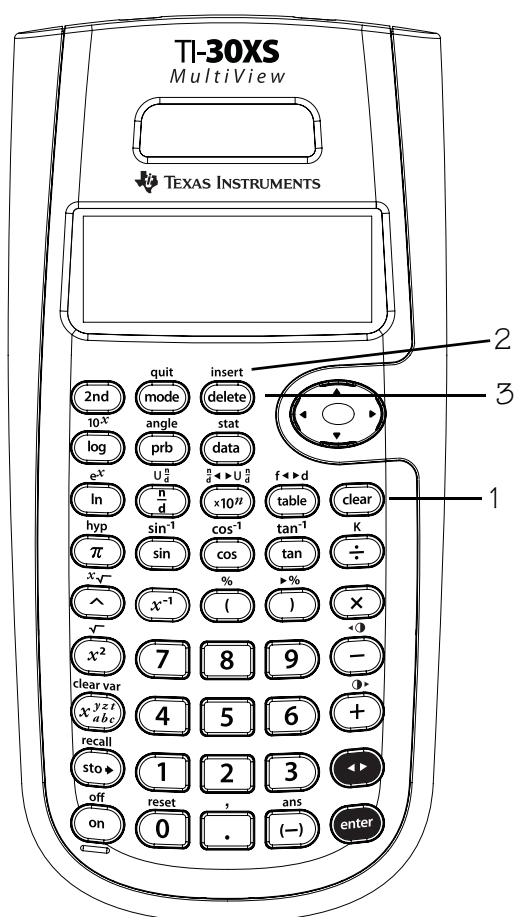

Delete and insert

Enter $4569 + 285$, and then change it to $459 + 2865$. Complete the problem.

Press	Display
4569 $+$ 285	4569+285 DEG
◀ ◀ ◀ ◀ ◀ ◀ delete	459+285 DEG
▶ ▶ ▶ ▶ 2nd [insert] 6	459+2865 DEG
enter	459+2865 DEG 3324



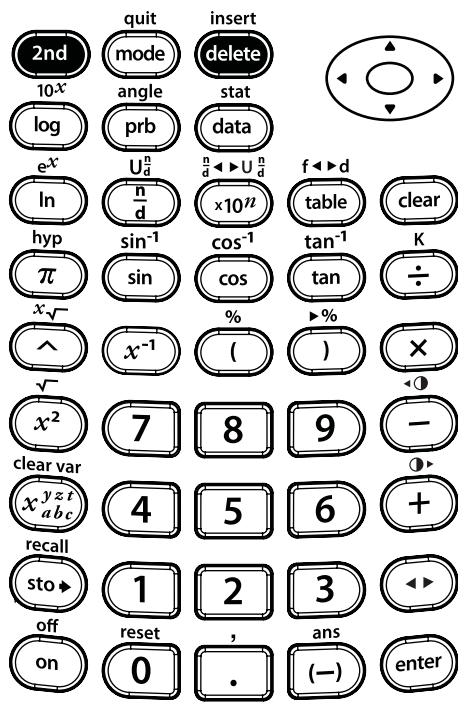

delete

2nd [insert]



Clear

Enter 21595.
 Clear the 95.
 Clear the entry.

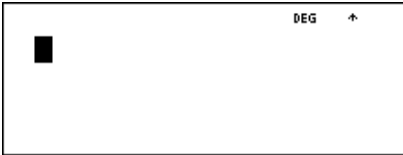
Press	Display
21595	
  clear	
clear	

clear

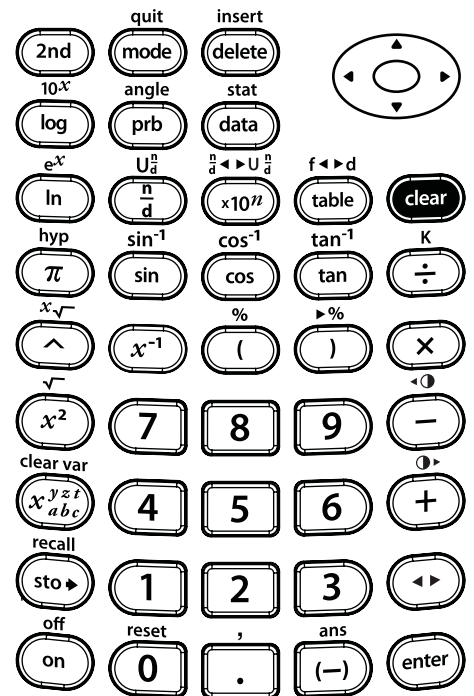
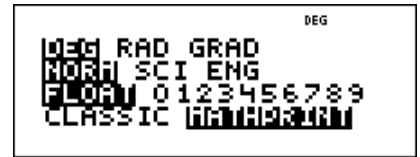

Keys

1. $\boxed{+}$ adds.
2. $\boxed{-}$ subtracts.
3. $\boxed{\times}$ multiplies.
4. $\boxed{\div}$ divides.
5. **enter** completes the operation or executes the command.
6. $\boxed{(-)}$ lets you enter a negative number.
7. **2nd** $\boxed{[\%]}$ appends the % sign to a number.

Notes

- The examples on the transparency masters assume all default settings.
- The TI-30XS MultiView™ allows implied multiplication.
Example: $3(4+3) = 21$
- Do not confuse $\boxed{(-)}$ with $\boxed{-}$. $\boxed{-}$ allows subtraction.
- Use parentheses to group the negation sign with the number if needed.
Example: $-2^2 = -4$, and $(-2)^2 = 4$.
- Results of percent calculations display according to the decimal notation mode setting.

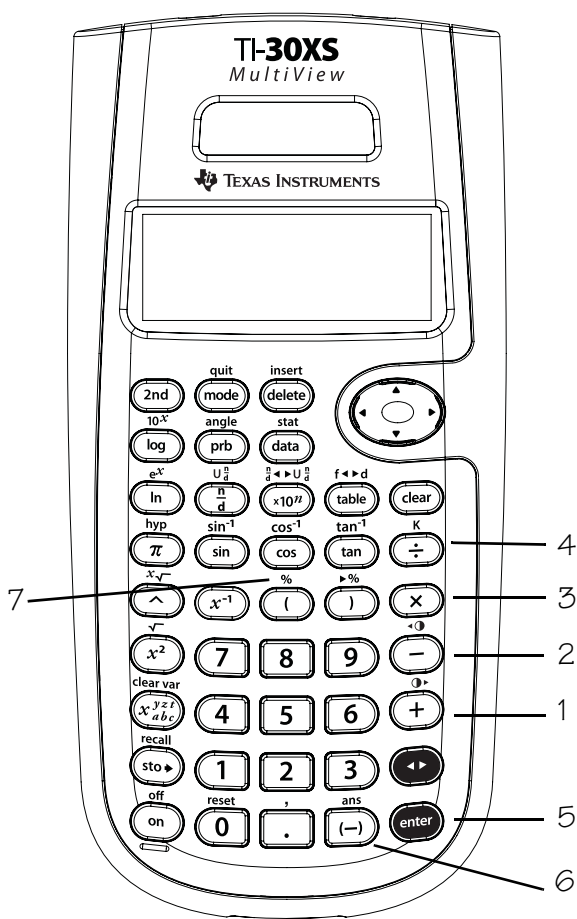

Add, subtract, multiply, divide, equals

Find:

$$2 + 54 - 6 =$$

$$16 \times 21 =$$

$$\frac{1}{2} \times 10 =$$

$$12 \times (5 + 6) =$$



enter

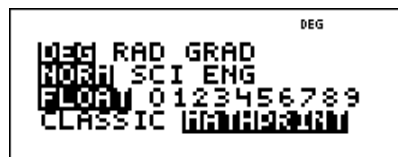

Press

Display

2 **+** 54 **-**
6 **enter**

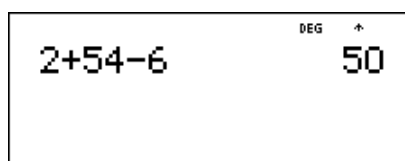

16 **x** 21 **enter**

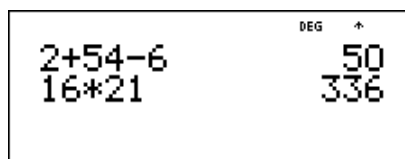

1 **n/d** 2 **→** **x**
10 **enter**

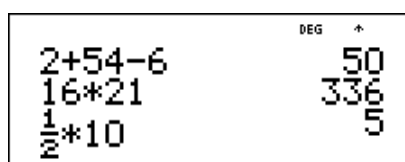

12 **x** (5 **+**
6 **)** **enter**

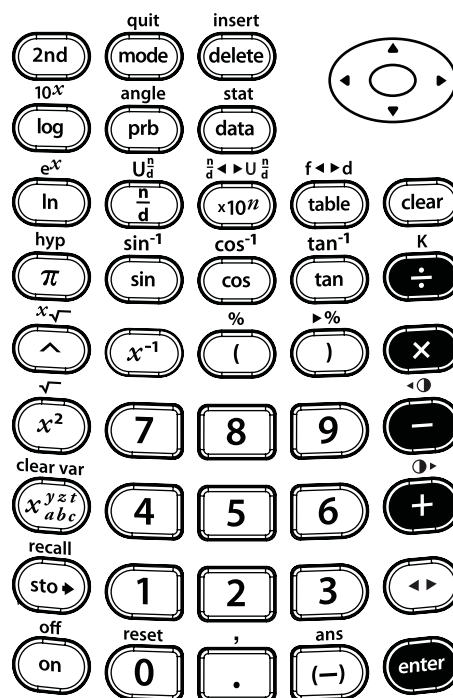
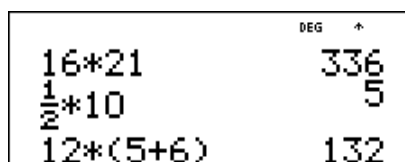

Negative numbers

The temperature in Utah was -3°C at 6:00 a.m. By 10:00 a.m. the temperature had risen 12°C . What was the temperature at 10:00 a.m.?

Press

(-) 3 **+**
12 **enter**

Display

$-3+12$ DEG \uparrow
 9

The temperature at 10:00 a.m. was 9°C .

(-)

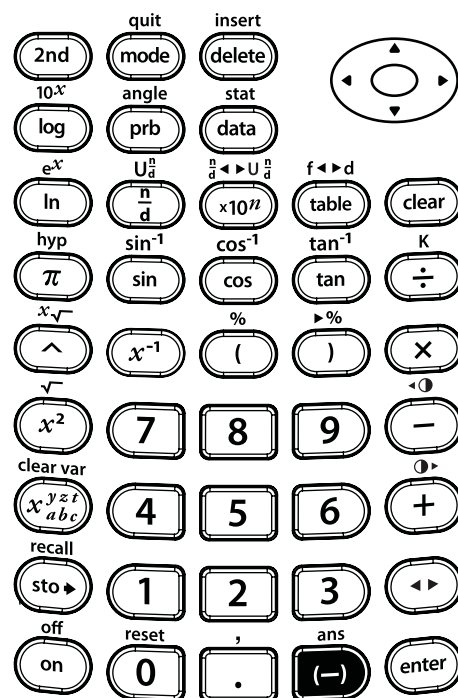

Percent

Mike makes \$80 per week. He saves 15% of his earnings. How much does Mike save per week?

Press	Display
15	15 DEG ↑
2nd [%] × 80 enter	15%*80 DEG ↑ 12

Mike saves \$12 per week.

2nd **[%]**

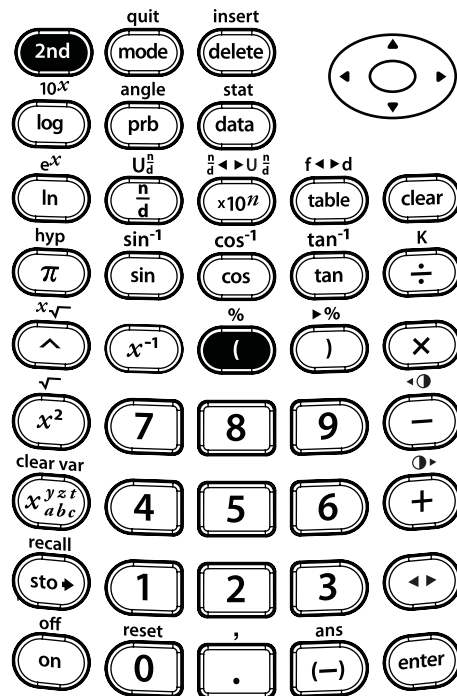

Order of operations and parentheses

4

Keys

1. $\left[\right]$ opens a parenthetical expression.
2. $\left) \right]$ closes a parenthetical expression.

Notes

- The examples on the transparency masters assume all default settings.
- The transparency master showing the Equation Operating System (EOS™) demonstrates the order in which the TI-30XS MultiView™ calculator completes calculations.
- Operations inside parentheses are performed first. Use $\left[\right]$ $\left) \right]$ to change the order of operations and, therefore, change the result.

Example: $1 + 2 \times 3 = 7$
 $(1 + 2) \times 3 = 9$

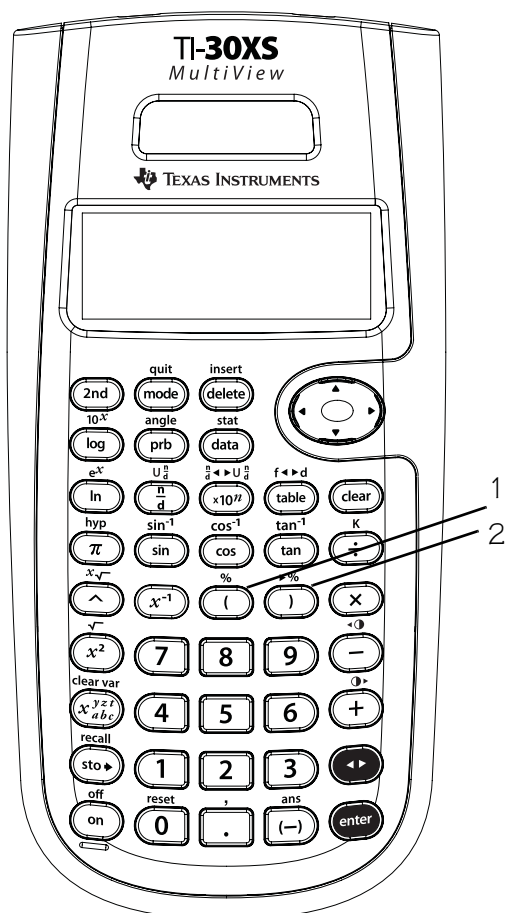

Equation Operating System (EOS™)

1 (first)	Expressions inside ()
2	Functions that need a () and precede the expression, such as $\boxed{\sin}$, $\boxed{\log}$, and some menu items
3	Fractions
4	Functions entered after the expression, such as $\boxed{x^2}$ and angle unit modifiers ($^\circ$, ', ", r , g)
5	<p>Exponentiation ($\boxed{\wedge}$) and roots ($\boxed{2nd}[\boxed{x\sqrt{\quad}}]$)</p> <p>Note: In Classic mode, exponentiation using the $\boxed{\wedge}$ key is evaluated from left to right. The expression 2^3^2 is evaluated as $(2^3)^2$, with a result of 64.</p> <p>In MathPrint™ mode, exponentiation using the $\boxed{\wedge}$ key is evaluated from right to left. Pressing $2 \boxed{\wedge} 3 \boxed{\wedge} 2$ displays as 2^{3^2}, with the result of 512.</p> <p>The TI-30XS MultiView™ scientific calculator evaluates expressions entered with $\boxed{x^2}$ and $\boxed{x^{-1}}$ from left to right in both Classic and MathPrint modes. Pressing $3 \boxed{x^2} \boxed{x^2}$ displays as 3^{2^2}. This is calculated as $(3^2)^2 = 81$.</p>

Equation Operating System (EOS™) (Continued)

6	Negation ($\boxed{(-)}$)
7	Permutations (\mathbf{nPr}) and combinations (\mathbf{nCr})
8	Multiplication, implied multiplication, and division
9	Addition and subtraction
10	Conversions ($\boxed{2nd} [\overset{n}{a} \blacktriangleleft \blacktriangleright U_a^n]$, $\boxed{2nd} [f \blacktriangleleft \blacktriangleright d]$, $\boxed{2nd} [\blacktriangleright \%]$, and $\blacktriangleright \mathbf{DMS}$)
11 (last)	enter completes all operations and closes all open parentheses.

Order of operations

$$1 + 2 \times 3 =$$

Press

1 **+** 2 **×**
3 **enter**

Display

1+2*3 DEG +
7

$$1 + (2 \times 3) =$$

Press

1 **+** (2 **×** 3
) **enter**

Display

1+2*3 DEG ++
1+(2*3) 7
7

$$(1 + 2) \times 3 =$$

Press

(1 **+** 2 **)**
× 3 **enter**

Display

1+2*3 DEG ++
1+(2*3) 7
(1+2)*3 9

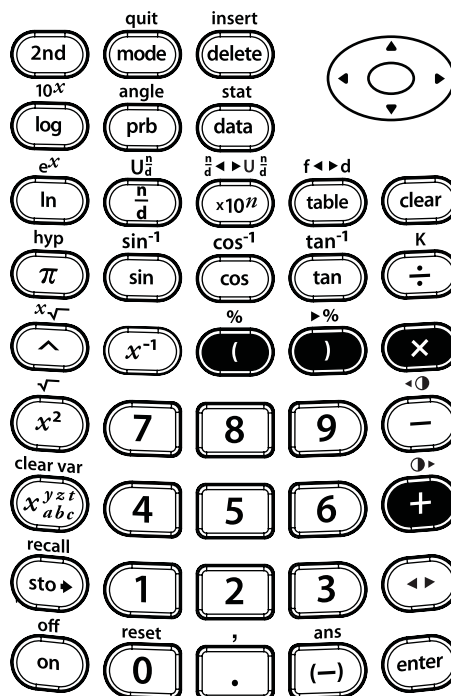
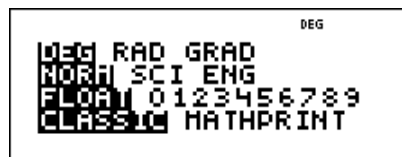

Order of operations (Continued)

$$\sqrt{5^2 - 4(1)(3)} = (\text{Classic mode})$$

Press

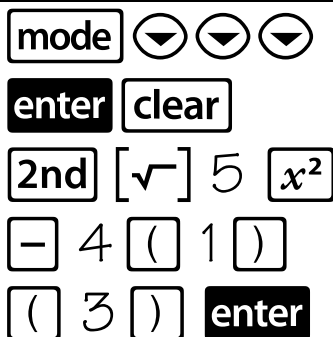

Display

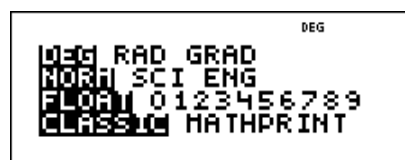
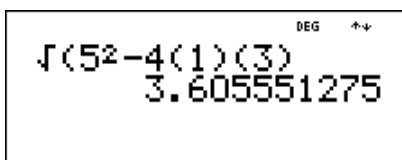

$$\sqrt{5^2 - 4(1)(3)} = (\text{MathPrint™ mode})$$

Press

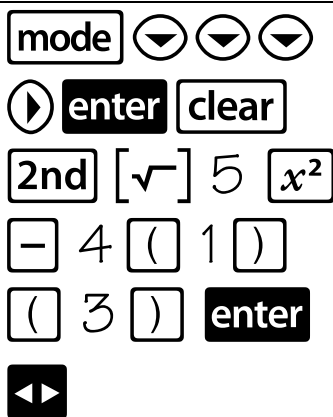

Display

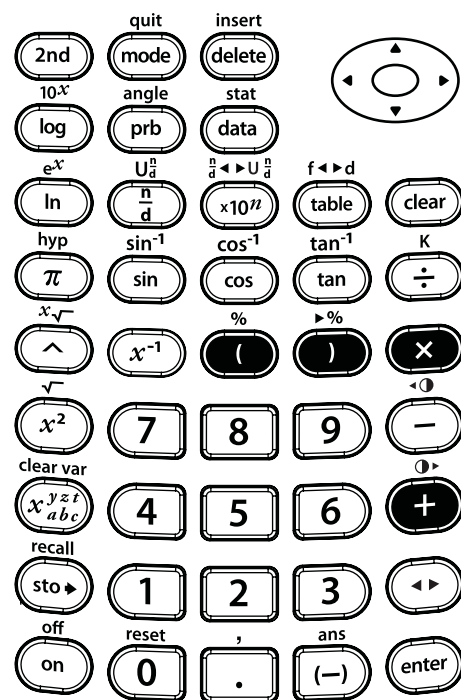
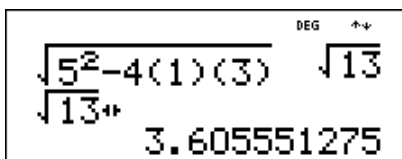
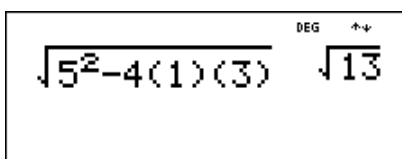

Keys

- mode** lets you choose from the following numeric notation menu.

NORM Restores standard mode (floating decimal).

SCI Turns on scientific mode and displays results as a number from 1 to 10 ($1 \leq n < 10$) times 10 to an integer power.

ENG Turns on engineering mode and displays results as a number from 1 to 1000 ($1 \leq n < 1000$) times 10 to an integer power. The integer power is always a multiple of 3.
- x10ⁿ** is a shortcut key to enter a number in scientific notation format.

Notes

- The examples on the transparency masters assume all default settings.
- You can enter a value in scientific notation regardless of the numeric notation mode setting. For a negative exponent, press **(-)** before entering it.
- Results requiring more than 10 digits are automatically displayed in scientific notation.
- For the decimal notation mode, refer to Chapter 7, Decimals and decimal places.
- These modes (**NORM**, **SCI**, and **ENG**) affect only the display of results.

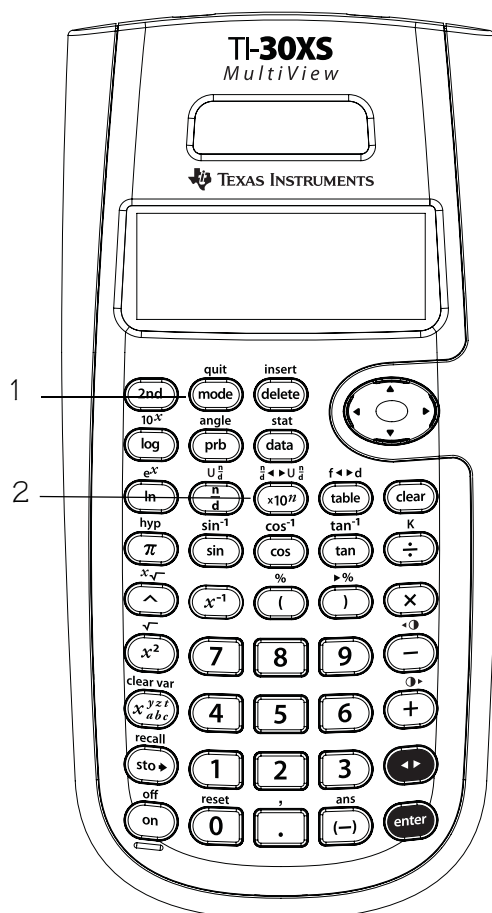

Engineering, scientific, floating decimal

Enter 12543, which will be in floating decimal notation and normal numeric notation (both default settings in **mode**). Alternate the display result between normal, scientific, and engineering notations by changing settings on the mode screen.

Press	Display
12543 enter	
mode enter	
clear enter	
mode enter	
clear enter	

mode

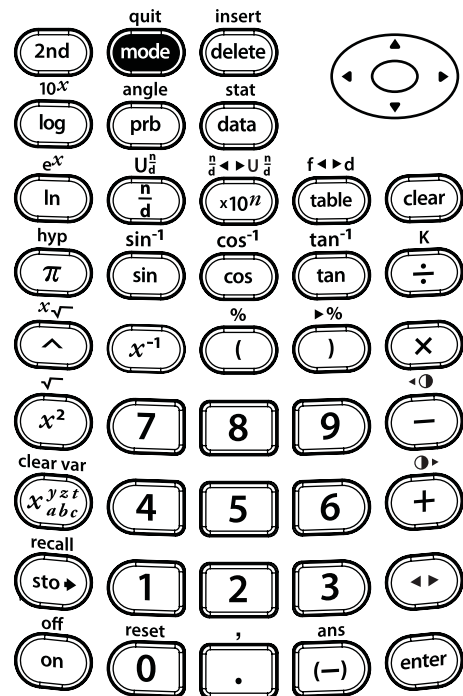
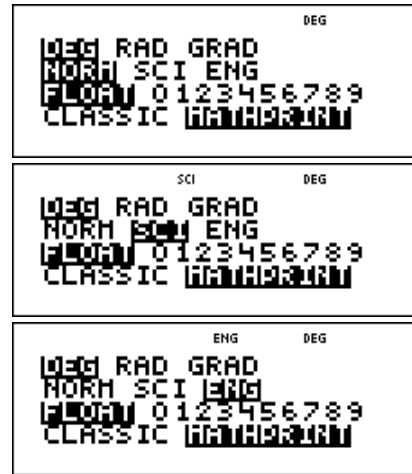

Engineering, scientific, floating decimal (Continued)

mode  enter
 clear enter

DEG +

12543
 12543 12.543*10³
 12543 12543

mode

DEG

MODE RAD GRAD
 NORM SCI ENG
 FLOAT 0 1 2 3 4 5 6 7 8 9
 CLASSIC MATH PWR ON

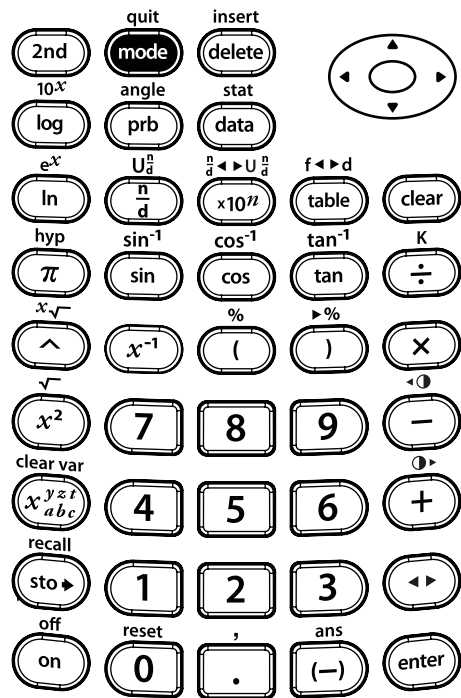

Scientific notation

With the TI-30XS MultiView™ calculator in Norm and MathPrint™ modes (both defaults), enter the following problem in scientific notation using the $\boxed{\times 10^n}$ key.

The Earth is approximately 1.5×10^8 kilometers from the Sun. Jupiter is approximately 7.8×10^8 kilometers from the Sun. Assuming the orbits of the planets are circular and the planets are on the same side of the sun, how close will Jupiter come to Earth?

Press	Display
7 . 8	
$\boxed{\times 10^n}$ 8 \blacktriangleright	
$\boxed{-}$ 1 . 5 $\boxed{\times 10^n}$	
8 enter	

Jupiter and Earth could be approximately
 $630,000,000 = 6.3 \times 10^8$
 kilometers apart.

$\boxed{\times 10^n}$

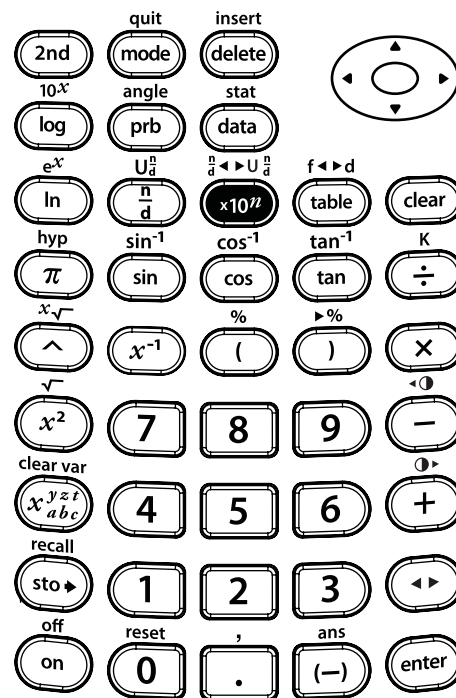

Keys

1. **$\boxed{2nd}\boxed{U_a}$** lets you enter mixed numbers and fractions. The unit must be an integer. The numerator and denominator can contain decimals.

To enter a mixed number, enter an integer for the unit, and then press **$\boxed{2nd}\boxed{U_a}$** to enter a numerator.

In MathPrint™ mode, pressing **$\boxed{2nd}\boxed{U_a}$** before entering an integer displays a fraction template, and allows only one digit to be entered for the unit.

2. **$\boxed{\frac{n}{d}}$** lets you enter a simple fraction. Pressing **$\boxed{\frac{n}{d}}$** before or after a number can result in differing behavior. In MathPrint™ mode, entering a number before pressing **$\boxed{\frac{n}{d}}$** usually makes that number the numerator.

$\boxed{\frac{n}{d}}$ in MathPrint mode can also be used for more complex fractional or formula computations that include operators and other functions by pressing **$\boxed{\frac{n}{d}}$** before you enter the numerator.

In MathPrint™ mode, press \odot between the entry of the numerator and the denominator. In Classic mode, press **$\boxed{\frac{n}{d}}$** between the entry of the numerator and the denominator.

3. **$\boxed{2nd}\boxed{a\leftarrow U_a}$** converts a simple fraction to a mixed number or a mixed number to a simple fraction.
4. **$\boxed{2nd}\boxed{f\leftarrow d}$** converts a fraction to its decimal equivalent or changes a decimal to its fractional equivalent, if possible.

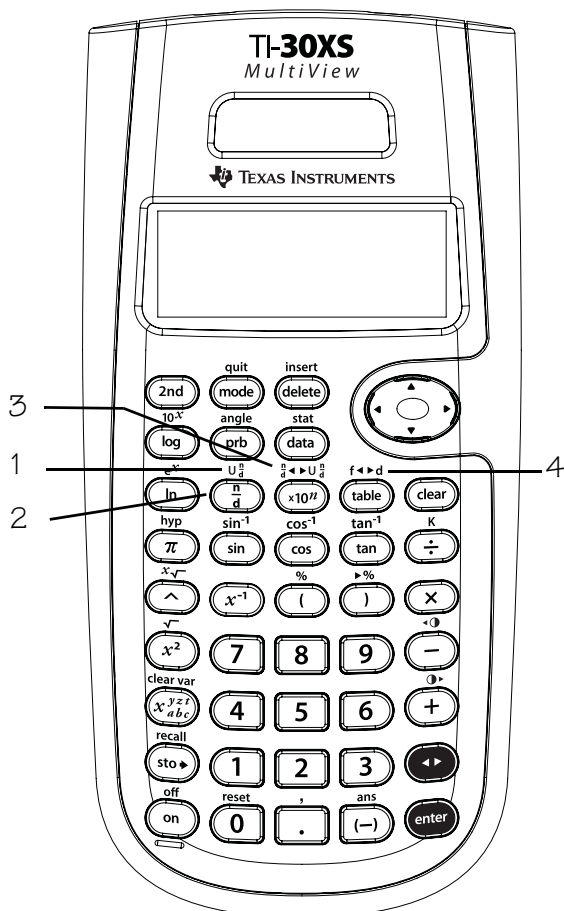

Notes

- The examples on the transparency masters assume all default settings.
- In MathPrint mode, fractions with **$\boxed{\frac{n}{d}}$** can include operation keys (**$\boxed{+}$** , **$\boxed{\times}$** , etc.) and most function keys (**$\boxed{x^2}$** , **$\boxed{2nd}\boxed{\%}$** , etc.). In Classic mode, fractions with **$\boxed{\frac{n}{d}}$** do not allow operation keys, functions, or complex fractions in the numerator or denominator.
- In MathPrint mode, you can enter variables (x, y, z, t, a, b, and c) in the numerator and denominator of a fraction. In Classic mode, fractions with **$\boxed{\frac{n}{d}}$** do not allow variables.
- In Classic mode, data editor, and table, use **$\boxed{\div}$** along with **$\boxed{[]}$** and **$\boxed{[]}$** where needed to perform complex division problems.

Fractions (Continued)

- To paste a previous entry in the denominator, place the cursor in the denominator, press **2nd** \leftarrow to scroll to the desired entry, and then press **enter** to paste the entry to the denominator.
- To paste a previous entry in the numerator or unit, place the cursor in the numerator or unit, press \leftarrow or **2nd** \leftarrow to scroll to the desired entry, and then press **enter** to paste the entry to the numerator or unit.
- Fractional results and entries are automatically simplified to their lowest terms.
- Calculations using fractions can display fraction or decimal results, depending on input.

Fractions

At the party, you ate $\frac{5}{6}$ of the

pepperoni pizza and $\frac{1}{10}$ of the

sausage pizza. The pizzas are the same size. If you put the pieces together, how much of one whole pizza did you eat?

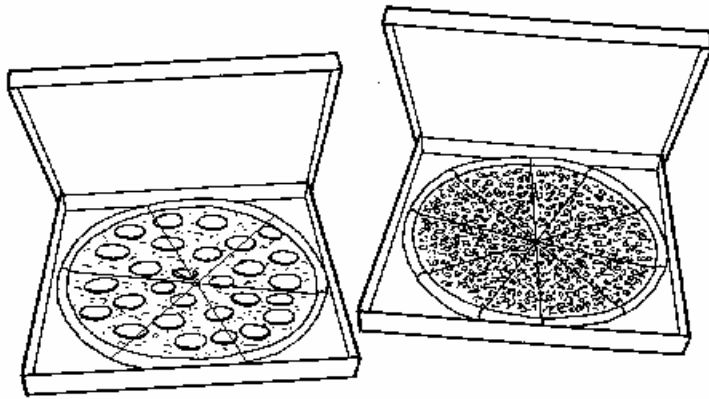

Press

5 $\frac{n}{d}$ 6 \rightarrow + 1
 $\frac{n}{d}$ 10 **enter**

Display

$\frac{5}{6} + \frac{1}{10}$ DEG $\frac{14}{15}$

You ate $\frac{14}{15}$ of the size of one whole pizza. That is almost an entire pizza!

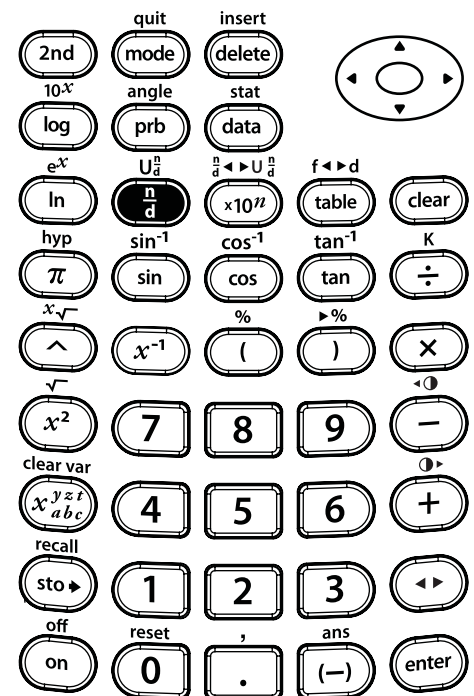
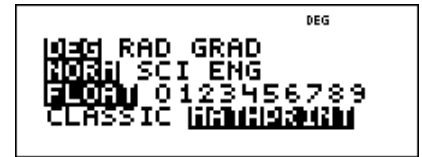

Mixed numbers

A baby weighed $4\frac{3}{8}$ pounds at birth.

In the next 6 months, she gained

$2\frac{3}{4}$ pounds. How much does she

weigh?

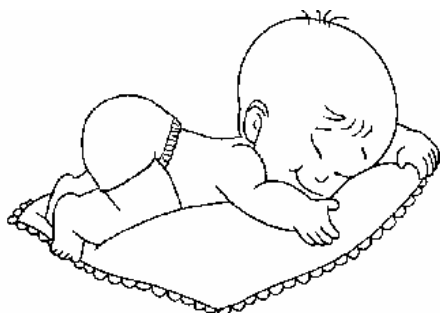

Press

Display

4 **2nd** [**U_dⁿ**] 3
 ⏴ 8 ⏵ **+** 2
2nd [**U_dⁿ**] 3 ⏴
 4 **enter**

DEG +
 $4\frac{3}{8} + 2\frac{3}{4}$
 $\frac{57}{8}$

2nd [**$\frac{n}{d} \leftarrow \rightarrow U_d^n$**]
enter

FIX DEG +
 $4\frac{3}{8} + 2\frac{3}{4}$
 $\frac{57}{8} \rightarrow \% \rightarrow U\%$
 $7\frac{1}{8}$

After 6 months, the baby weighs

$7\frac{1}{8}$ pounds.

2nd [**U_dⁿ**]

2nd [**$\frac{n}{d} \leftarrow \rightarrow U_d^n$**]

DEG
 DEG RAD GRAD
 NORM SCI ENG
 FLOA 0 1 2 3 4 5 6 7 8 9
 CLASSIC **|||||**

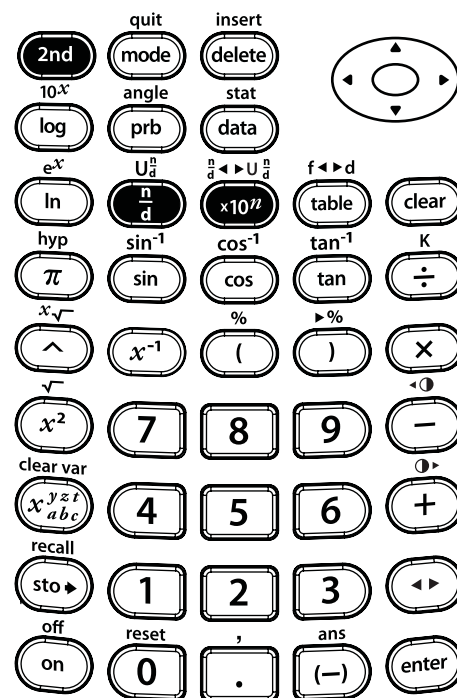

Converting fractions and decimals

Juan swims 20 laps in 5.72 minutes.

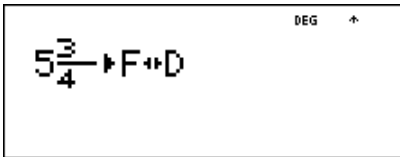
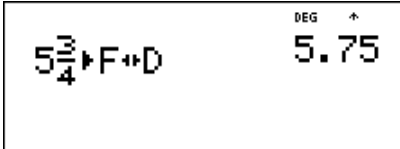

Mary swims 20 laps in $5\frac{3}{4}$ minutes.

Change Mary's time to a decimal to determine who swims faster.

Press	Display
5 2nd [U_aⁿ] 3 ⏴ 4 ⏵ 2nd [f◀▶d] enter	
	

Juan swims faster than Mary since he swims 20 laps in 5.72 minutes.

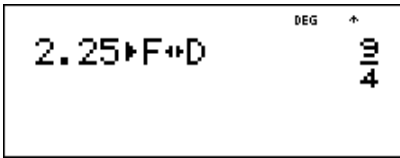
Change 2.25 to its fractional equivalent.

Press	Display
2 □ 25 2nd [f◀▶d] enter	
or	
2 □ 25 enter ◀▶	

2nd [**f◀▶d**]

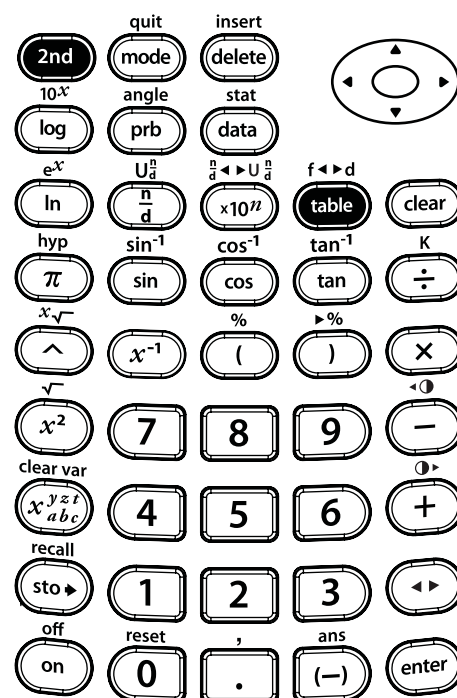
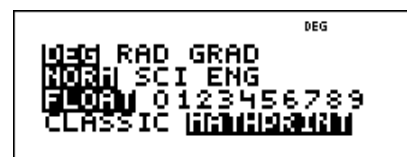

Decimals and decimal places

7

Keys

1. \square enters a decimal point.
2. **mode** lets you set the number of decimal places. Press $\downarrow \downarrow$ and then \uparrow to the choice of decimal desired. Press **enter** to select it.

FLOAT Sets floating decimal (standard) notation.

0-9 Sets the number of decimal places displayed. **FIX** displays when a decimal mode is set from 0-9.

Notes

- The examples on the transparency masters assume all default settings.
- Press **mode** $\downarrow \downarrow$ **enter** to return to standard notation (floating decimal).
- The decimal mode setting affects most decimal results and the mantissa of scientific and engineering notation results.
- The TI-30XS MultiView™ calculator automatically rounds the result to the number of decimal places selected. For example, when the decimal is set to 2 places, 0.147 becomes 0.15 when you press **enter**. The TI-30XS MultiView calculator also rounds or pads resulting values with trailing zeros to fit the selected setting. For example, when the decimal is set to 5 places, 0.147 becomes 0.14700 when you press **enter**.
- Resetting the calculator clears the decimal setting and resets to the default, **FLOAT**.
- The decimal setting does not affect the internal precision of results. It affects only the way results are displayed.

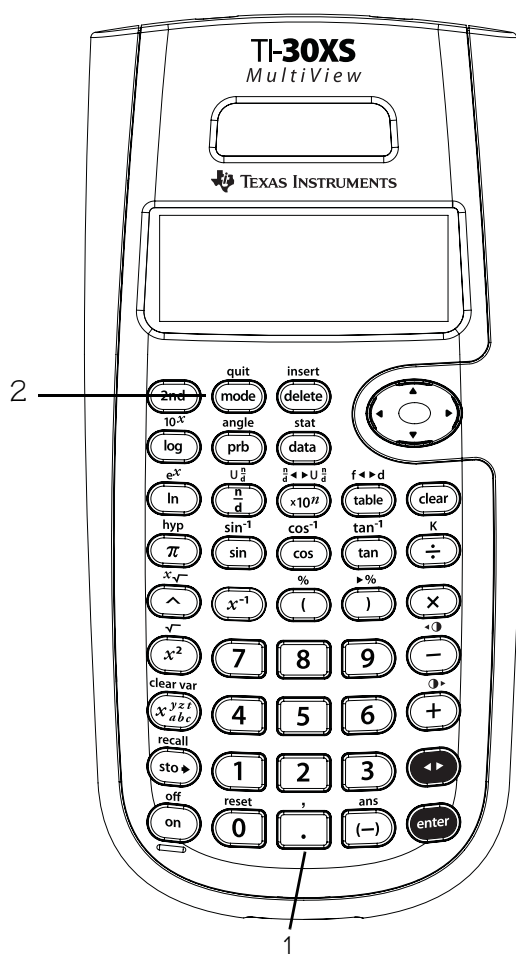

Decimal

Round 12.345 to the hundredths place, to the tenths place, and then to floating notation.

Press	Display
12 \square 345 enter	
mode \downarrow \downarrow \rightarrow \rightarrow \rightarrow enter	
clear enter	
mode \downarrow \downarrow \rightarrow \rightarrow enter	
clear enter	
mode \downarrow \downarrow enter	
clear enter	

mode

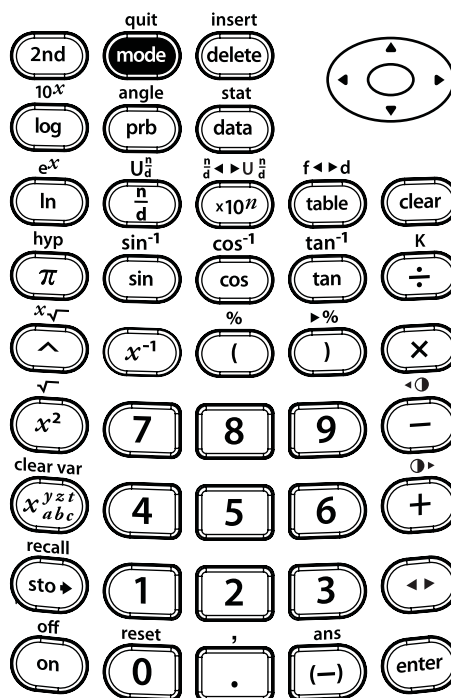

Keys

1. **2nd** [**K**] turns the constant feature on and off, and lets you define a constant number, operation, or expression for a shortcut when repeating a set of keystrokes. **K** displays when the constant mode is on.
2. **enter** places the contents of **K** at the end of the expression in the display.

Notes

- The examples on the transparency masters assume all default settings.
- All operations, functions, and values work in constant mode.
- To enter a constant:
 1. Press **2nd** [**K**]. If a constant is already stored, press **clear** to clear it.
 2. Enter the constant (any set of operations, functions, and values).
 3. Press **enter** to turn on the constant feature. **K** appears in the display to indicate the constant feature is on.
 4. Press **clear** to clear the display.
 5. Enter an initial value. If you do not enter a value, 0 is assumed, and **Ans** will appear in the display.
 6. Press **enter** to place the contents of **K** at the end of the expression and evaluate it.
 7. Continue pressing **enter** to repeat the constant.
 8. Press **2nd** [**K**] again to turn off the constant feature.

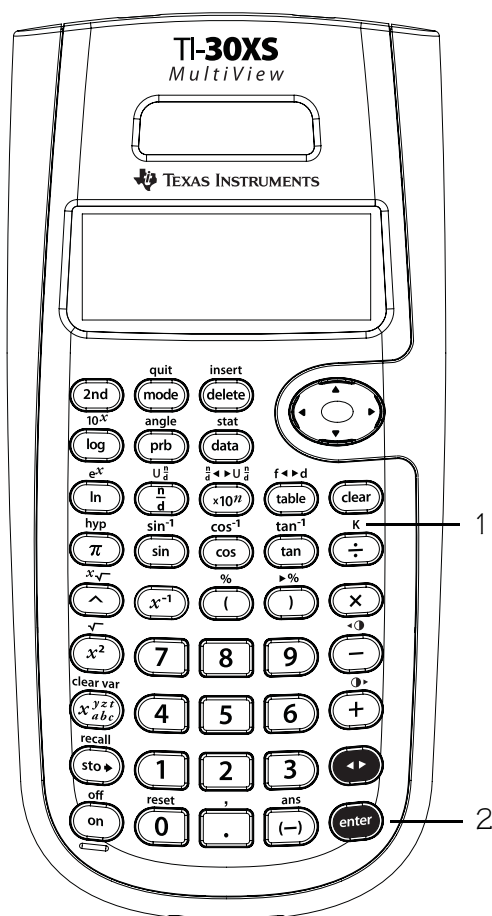

Constant

Three people babysit for \$5.25 each per hour. The first person works 16 hours. The second person works 12 hours. The third person works 17 hours. How much did each person earn?

2nd [K]

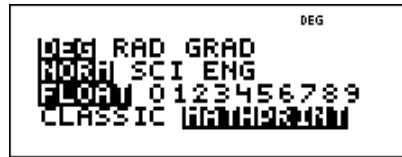

Press

Display

2nd [K]

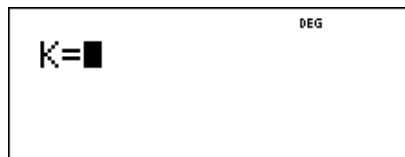

× 5.25 **enter**



clear



16 **enter**



12 **enter**

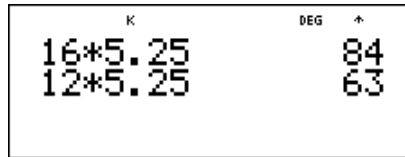

17 **enter**

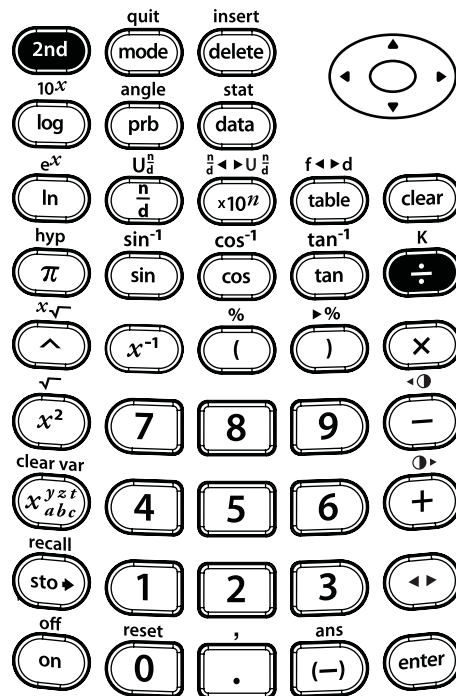
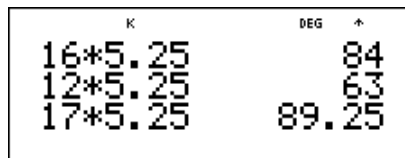

Constant (Continued)

2nd **[K]**

	DEG	↑
16*5.25		84
12*5.25		63
17*5.25		89.25

(Constant mode is off.)

2nd **[K]**

DEG	
MODE	RAD GRAD
NORM	SCI ENG
FIX	0 1 2 3 4 5 6 7 8 9
CLASSIC	NUMPDRUM

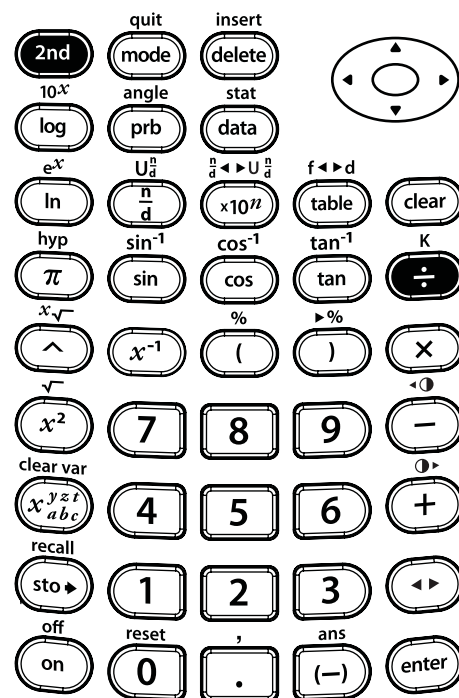

Keys

1. **sto** lets you store values to variables. Press **sto** to store a variable, and press x_{abc}^{yzt} to select the variable to store. Press **enter** to store the value in the selected variable. If this variable already has a value, that value is replaced by the new one.
2. x_{abc}^{yzt} accesses variables. Press this key multiple times to choose **x**, **y**, **z**, **t**, **a**, **b**, or **c**. You can also use x_{abc}^{yzt} to recall the stored values for these variables.

3. **2nd** [clear var] clears all variables.
4. **2nd** [recall] displays a menu of the variables **x**, **y**, **z**, **t**, **a**, **b**, and **c**, and lets you view their stored values before pasting to the display.

Notes

- The examples on the transparency masters assume all default settings.
- You can store a number or an expression that results in a number to a memory variable.
- When you select a variable using x_{abc}^{yzt} , the variable name (**x**, **y**, **z**, **t**, **a**, **b**, or **c**) is displayed. The variable name is inserted into the current entry, but the value assigned to the variable is used to evaluate the expression.
- When you select a variable using **2nd** [recall], a menu is displayed showing the value of the stored variables. Select the variable by pressing the corresponding menu number. The value assigned to the variable is inserted into the current entry and used to evaluate the expression.
- Resetting the calculator clears all memory variables.

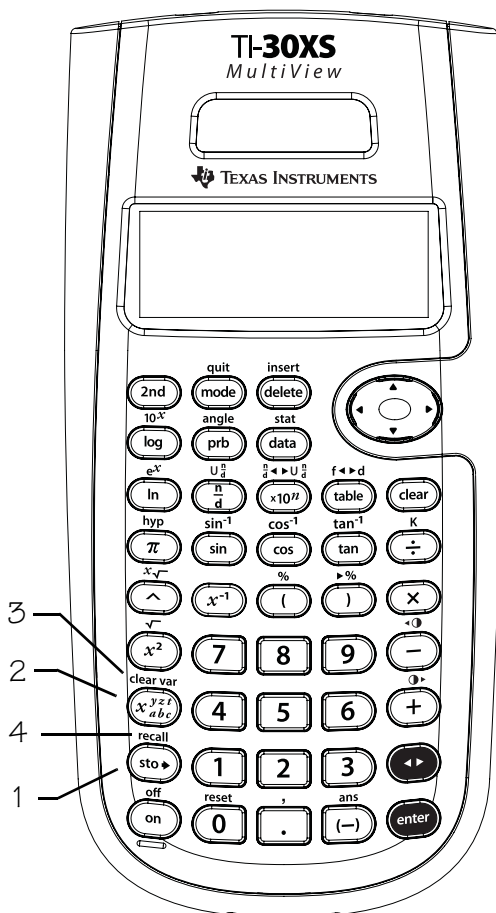

Store, variables

Following are your scores for tests and homework in your math class.

Test scores: 96, 76, 85.

Homework scores: 92, 83, 97, 86.

1. Find your test grade as the average of your test scores.
2. Find your homework grade as the average of your homework scores.
3. Your teacher will compute your final grade as the average of your test grade and your homework grade. What is your final grade? Your teacher will round to the nearest whole number if needed.

Press	Display
96 + 76 +	96+76+85 DEG \uparrow 257
85 enter	

sto \rightarrow x^{yzt}
 abc

2nd **[recall]**

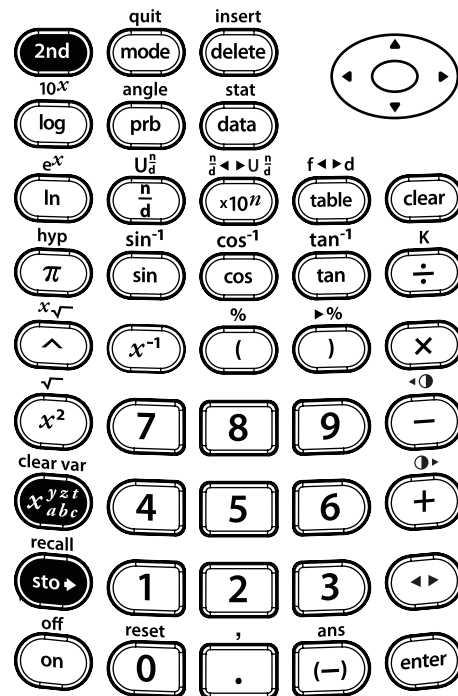

Store, variables (Continued)

\div 3 **enter**

```

DEG  +
96+76+85      257
Ans÷3
      85.66666667
    
```

sto x^{yzt}
enter

```

DEG  +
Ans÷3
      85.66666667
Ans→x
      85.66666667
    
```

92 **+** 83 **+**
97 **+** 86
enter

```

DEG  +
      85.66666667
Ans→x
      85.66666667
92+83+97+86  358
    
```

\div 4 **enter**

```

DEG  +
Ans→x
      85.66666667
92+83+97+86  358
Ans÷4
      89.5
    
```

+ x^{yzt} **enter**

```

DEG  +
92+83+97+86  358
Ans÷4
      89.5
Ans→x
      175.1666667
    
```

\div 2 **enter**

```

DEG  +
Ans→x
      175.1666667
Ans÷2
      87.58333333
    
```

Your final grade is 88 rounded to the nearest whole number.

sto x^{yzt}
abc

2nd **[recall]**

```

DEG
MODE RAD GRAD
NORMAL SCI ENG
FLOOR 0123456789
CLASSIC [MATH] [P/AM]
    
```

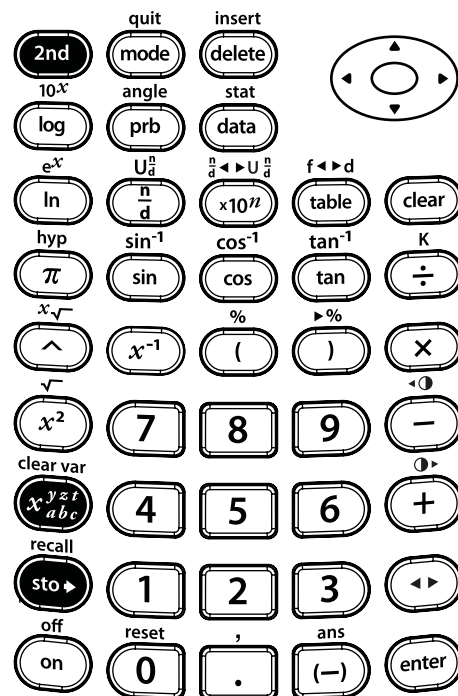

Store, recall

You are going to ship a gift to each of two friends. You see the gifts at two web sites for the same price. The shipping charges are different at each site. The packages weigh 4.5 pounds and 3.2 pounds. Store A will ship a package for €2 plus €1.40 per pound. Store B will ship the package for €3 plus €1.10 per pound. Which store will charge the least for shipping each gift?

Press

Display

4 \cdot 5 **sto**
 x^{yzt} **enter**

4.5→x 4.5

2 + x^{yzt} (1
 \cdot 40) **enter**

4.5→x 4.5
 2+x(1.40) 8.3

3 + x^{yzt} (1
 \cdot 10) **enter**

4.5→x 4.5
 2+x(1.40) 8.3
 3+x(1.10) 7.95

Store A charges €8.30 and store B charges €7.95. Store B charges less to ship the gift that weighs 4.5 pounds.

sto →

2nd [recall]

```

DEG RAD GRAD
NORM SCI ENG
FLOOR 0123456789
CLASSIC
    
```

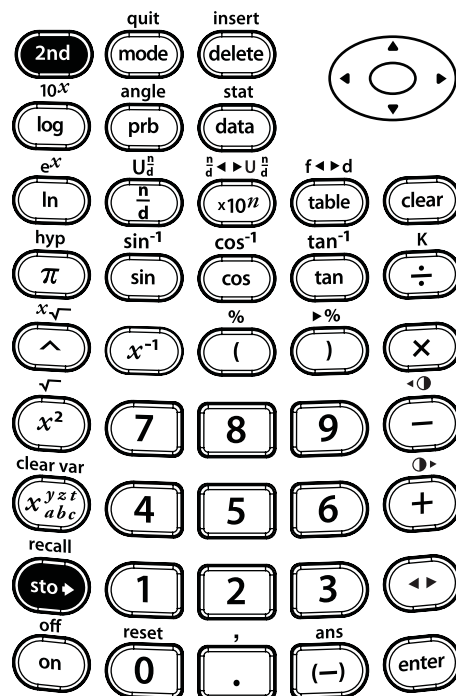

Store, recall (Continued)

3 \square 2 **sto**
 x^{yzt} **enter**

```

DEG  +
4.5+x      4.5
2+x(1.40)  8.3
3+x(1.10)  7.95
3.2+x      3.2
    
```

\uparrow \uparrow \uparrow \uparrow \uparrow
 \uparrow **enter** **enter**

```

DEG  ++
2+x(1.40)  8.3
3+x(1.10)  7.95
3.2+x      3.2
2+x(1.40)  6.48
    
```

\uparrow \uparrow \uparrow \uparrow \uparrow
 \uparrow **enter** **enter**

```

DEG  ++
3+x(1.10)  7.95
3.2+x      3.2
2+x(1.40)  6.48
3+x(1.10)  6.52
    
```

Store A charges €6.48 and store B charges €6.52. Store A charges less to ship the gift that weighs 3.2 pounds.

sto

2nd **[recall]**

```

DEG
MODE RAD GRAD
NORM SCI ENG
FLOOR 0123456789
CLASSIC
    
```

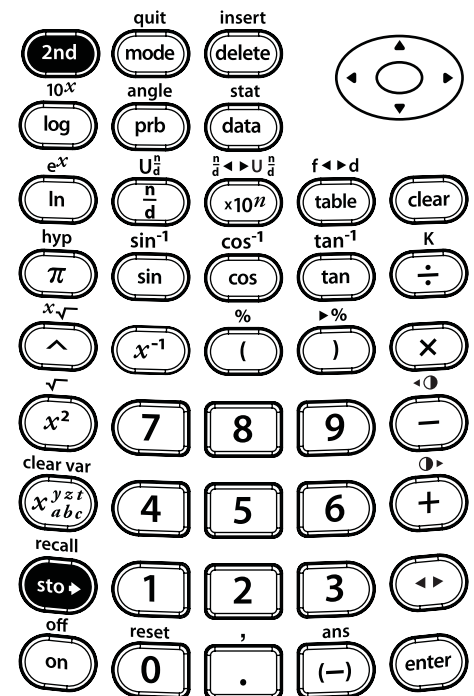

Store, recall (Continued)

Shop	Purchases	Qty	Cost
A	shirts	2	€13.98 ea.
B	ties	3	€7.98 ea.
C	belt	1	€6.98
	suspenders	1	€9.98

How much did you spend at each shop, and how much did you spend altogether?

Press

Display

2 \times 13 \square
98 **enter**

2*13.98 27.96
DEG +

sto x^{yzt}_{abc} **enter**

2*13.98 27.96
Ans \rightarrow x 27.96
DEG +

3 \times 7 \square
98 **enter**

2*13.98 27.96
Ans \rightarrow x 27.96
3*7.98 23.94
DEG +

sto x^{yzt}_{abc}
 x^{yzt}_{abc} **enter**

2*13.98 27.96
Ans \rightarrow x 27.96
3*7.98 23.94
Ans \rightarrow y 23.94
DEG +

sto \rightarrow

2nd [recall]

```

DEG RAD GRAD
NORM SCI ENG
FLOA 0 1 2 3 4 5 6 7 8 9
CLASSIC
  
```

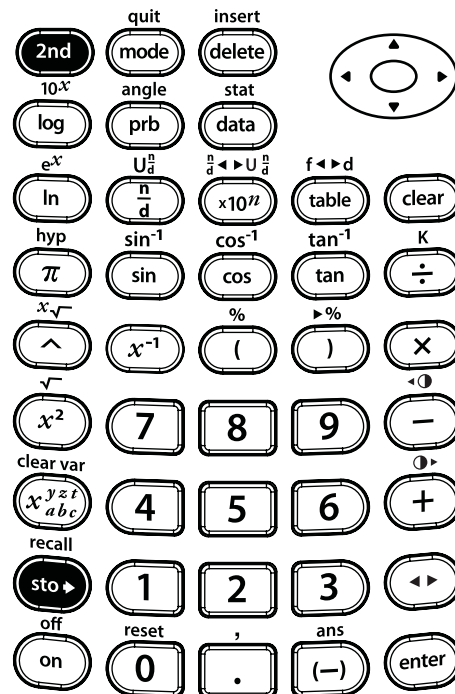

Store, recall (Continued)

6 \square . 98 \square +
 9 \square . 98 **enter**

```

DEG  +
Ans→x      27.96
3*7.98     23.94
Ans→y      23.94
6.98+9.98  16.96
  
```

sto \rightarrow x_{abc}^{yzt}
 x_{abc}^{yzt} x_{abc}^{yzt} **enter**

```

DEG  +
3*7.98     23.94
Ans→y      23.94
6.98+9.98  16.96
Ans→z      16.96
  
```

2nd [recall]

```

DEG
Recall Var
1: x=27.96
2: y=23.94
3: z=16.96
  
```

1 \square + **2nd** [recall]
 2 \square + **2nd**
 [recall] 3 **enter**

```

DEG  ++
6.98+9.98  16.96
Ans→z      16.96
27.96+23.94+16.9  68.86
  
```

You spent:

€27.96 at shop A,
 €23.94 at shop B,
 €16.96 at shop C.

You spent €68.86 at all three shops.

sto \rightarrow

2nd [recall]

```

DEG
MODE RAD GRAD
NORMAL SCI ENG
FLOOR 0123456789
CLASSIC MATHS/STAT
  
```

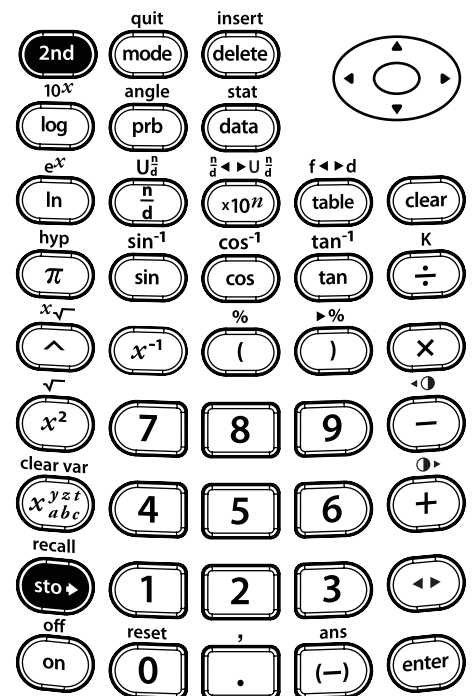

Keys

1. **[data]** displays a data editor with three lists. Each list can contain up to 42 items. To enter data, navigate to a list and enter a number. Press the arrow keys to navigate list elements.

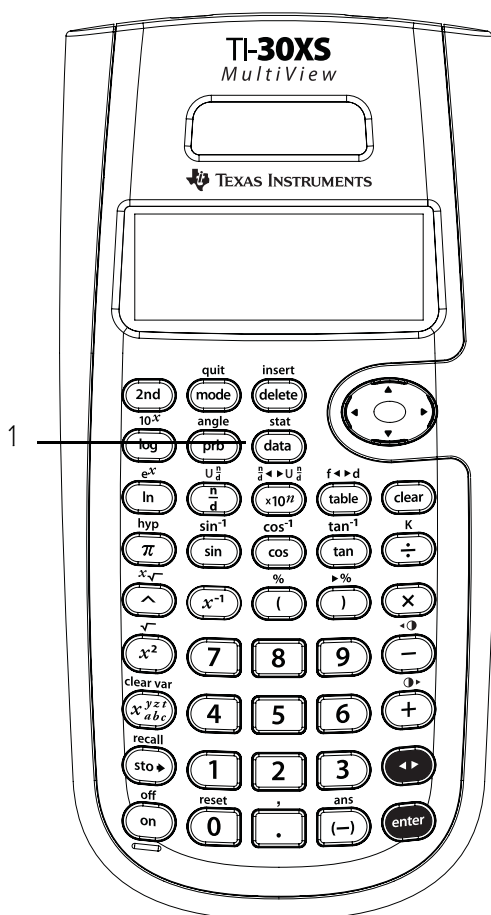

Notes

- The examples on the transparency masters assume all default settings.
- List formulas accept all calculator functions.
- In formulas, use **[(]** and **[)]** around variables or list names to ensure the desired order of operations.
- If a formula is entered to a list, the formula list automatically updates if a referenced list element is updated.

Note: Pressing **[enter]** in a formula list automatically deletes the formula. No message is displayed.

- When a formula is deleted, the data remains for use. The data is no longer updated.
- Pressing **[data]** again from the data editor screen opens menus with options to clear lists or to enter and manage formulas.
- Pressing **[data]** again when in “Add/edit formula” option opens a menu containing list names you can use when adding or editing formulas.
- Pressing **[clear]** backs up screens within the data editor.
- Pressing **[2nd] [quit]** exits the data editor and returns you to the Home screen.
- In the data editor, scientific notation displays as **E** to conserve space but still show the magnitude of a number.
Example: 2×10^3 appears as $2E3$.

Entering data and formulas

On a November day, a weather report on the Internet listed the following temperatures.

Paris, France 8°C

Moscow, Russia -1°C

Montreal, Canada 4°C

Convert these temperatures from degrees Celsius to degrees Fahrenheit.

Reminder: $F = \frac{9}{5}C + 32$.

Press	Display
data 8 \blacktriangledown (-) 1 \blacktriangledown 4 \blacktriangledown \blacktriangleright	
data \blacktriangleright	
1	
9 \div 5 \times data 1 $+$ 32	

data

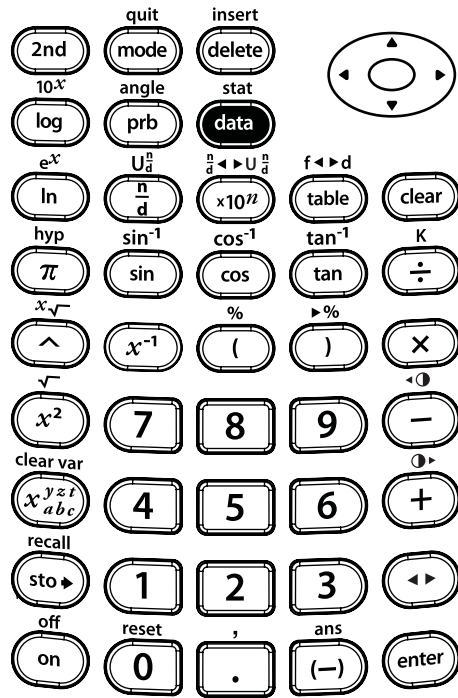

Entering data and formulas (Continued)

enter

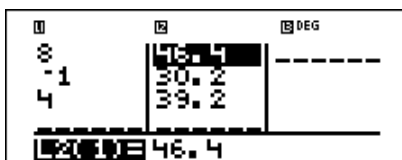

Notice L2 is highlighted, since it is the result of a formula.

The degrees Fahrenheit are:

Paris, France 46.4°F
 Moscow, Russia 30.2°F
 Montreal, Canada 39.2°F

If Sydney, Australia is 21°C, find the temperature in degrees Fahrenheit.





 21 **enter**

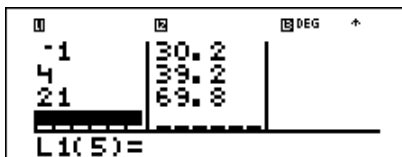

The temperature in Sydney, Australia is 69.8°F.

data

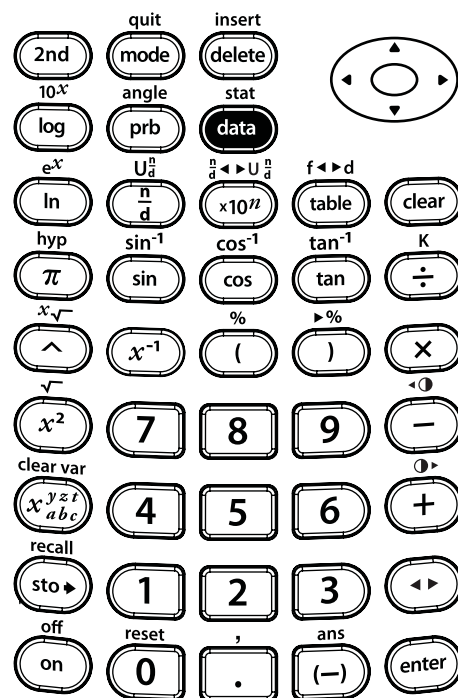

Keys

1. **[data]** lets you enter data points (x for **1-Var** stats; x and y for **2-Var** stats). (See Chapter 10, Data editor and list formulas, for more details on **[data]**.)
2. **[2nd][stat]** displays a menu from which you can select **1-Var**, **2-Var** or **StatVars**.

1-Var Analyzes data from 1 set of data with 1 measured variable— x .

2-Var Analyzes paired data from 2 sets of data with 2 measured variables— x , the independent variable, and y , the dependent variable.

StatVars This option appears only after you have calculated 1-var or 2-var stats. Displays the menu of variables with their current values.

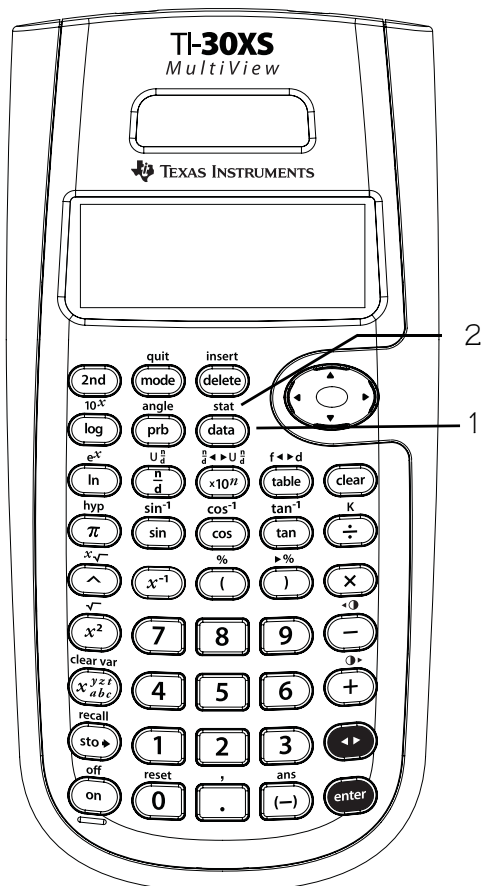

StatVars menu:

n	Number of x (or x,y) data points.
\bar{x} or \bar{y}	Mean of all x or y values.
Sx or Sy	Sample standard deviation of x or y .
σ_x or σ_y	Population standard deviation of x or y .
Σx or Σy	Sum of all x values or y values.
Σx^2 or Σy^2	Sum of all x^2 values or y^2 values.
Σxy	Sum of the product of x and y for all $x-y$ pairs in the 2 lists.
a	Linear regression slope.
b	Linear regression y -intercept.
r	Correlation coefficient.
x' (2-var)	Uses a and b to calculate predicted x value when you input a y value.
y' (2-var)	Uses a and b to calculate predicted y value when you input an x value.
minX	Minimum of x values.
Q1 (1-var)	Median of the elements between minX and Med (1st quartile).
Med	Median of all data points.
Q3 (1-var)	Median of the elements between Med and maxX (3rd quartile).
maxX	Maximum of x values.

Notes

- The examples on the transparency masters assume all default settings.
- You can change data points by going to the Data editor, navigating to the data element, and changing the value entered.

Note: You must then recalculate 1-var or 2-var stats to display the StatVars option.

Entering 1-Var stat data

Five students took a math test.
Using their scores, enter the data
points—85, 85, 97, 53, 77.

Press

Display

data

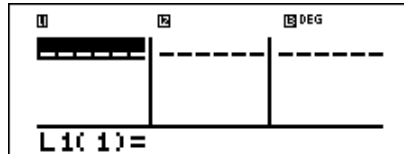

85 \blacktriangledown 97 \blacktriangledown 53
 \blacktriangledown 77 \blacktriangledown

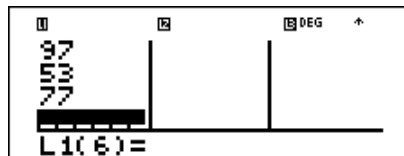

\blacktriangleright 2 \blacktriangledown 1 \blacktriangledown 1
 \blacktriangledown 1 \blacktriangledown

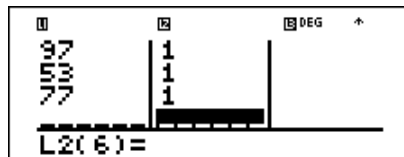

Continued

2nd **[stat]** **data**

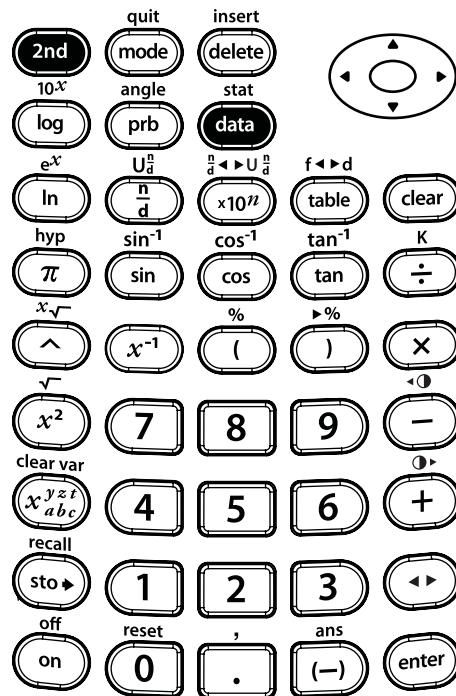

Viewing the statistics

Find the number of data points (n), the mean (\bar{x}), the sample standard deviation (Sx), the population standard deviation (σx), the sum of the scores (Σx), the sum of the squares (Σx^2), and the five-number summary of the data, minX, Q1, Q2, and maxX.

Press

Display

2nd **[stat]**

```

DEG
STAT
1:1-Var Stats
2:2-Var Stats
    
```

1 **▼** **▶** **▶**
enter **▼**

```

DEG
1-VAR STATS
DATA: [L1] L2 L3
FRQ: ONE L1 [L2] L3
CALC
    
```

enter

```

DEG
1-Var: [L1] [L2]
1:n=5
2:x=79.4
3:Sx=16.39512123
    
```

▼ **▼** **▼** **▼** **▼**

```

DEG
1-Var: [L1] [L2]
4:σx=14.66424222
5:Σx=397
6:Σx^2=32597
    
```

▼ **▼** **▼**

```

DEG
1-Var: [L1] [L2]
7:minX=53
8:Q1=77
9:Med=85
    
```

▼ **▼**

```

DEG
1-Var: [L1] [L2]
9:Med=85
A:Q3=85
B:maxX=97
    
```

2nd **[stat]** **data**

```

DEG
MODE RAD GRAD
NORM SCI ENG
FLOOR 0123456789
CLASSIC MATHPARM
    
```

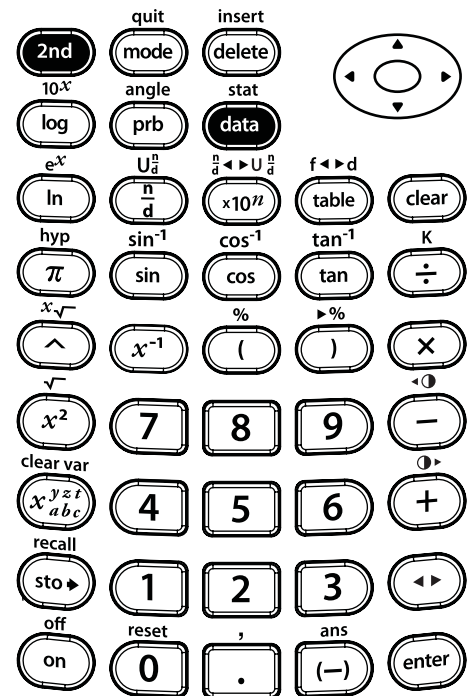

Removing data points

Drop the lowest test score by editing the data in L1 in the data editor.

Make sure you update the frequency list, L2, if needed. Find the new mean (\bar{x}). Finally, clear the data from all of the lists.

Press

Display

data



⏴ ⏵

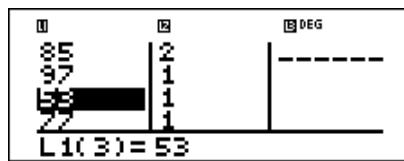

delete ⏴ **delete**

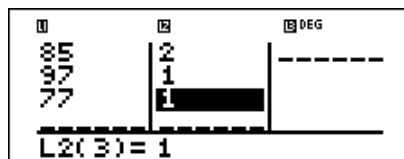

2nd [stat] 1

⏴ ⏵ **enter**

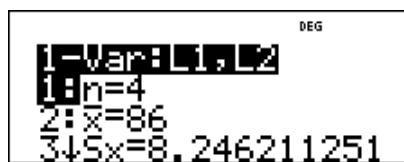

data **data** 4

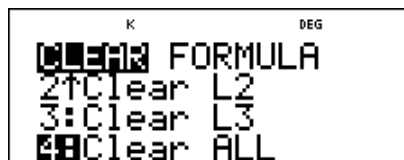

2nd [quit]

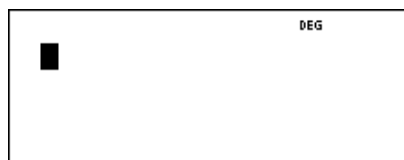

data

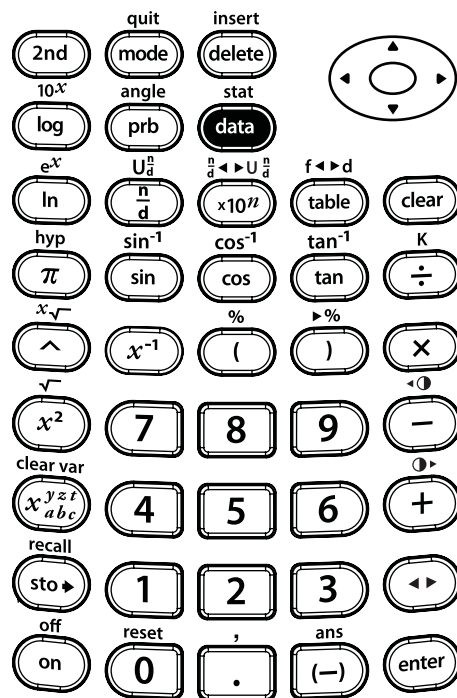

Entering 2-Var stat data

The table below shows the number of pairs of athletic shoes sold by a small shoe store. The table shows the total number of pairs of shoes sold for two months and the total number of pairs of Brand A shoes sold during the same months. Enter this data in the data editor.

Month	Total No. (x)	Brand A (y)
April	58	35
May	47	28

Press

Display

data 58 \blacktriangledown

47 \blacktriangledown

\blacktriangleright 35 \blacktriangledown 28 \blacktriangledown

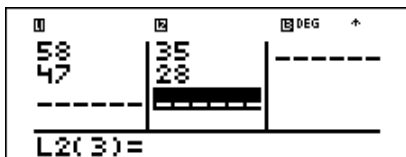
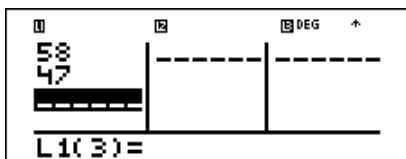

2nd **[stat]** **data**

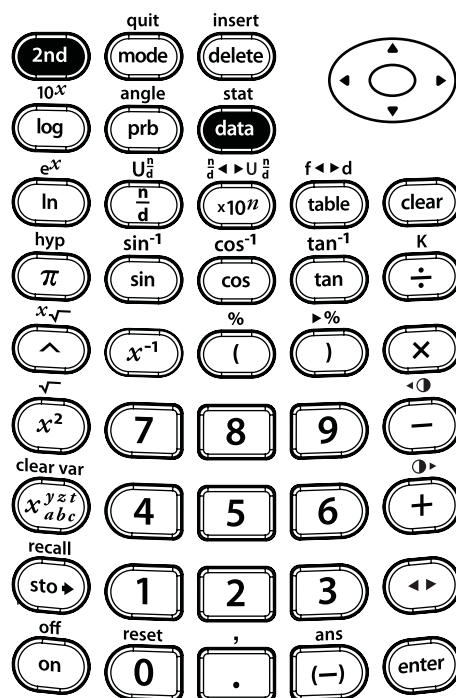
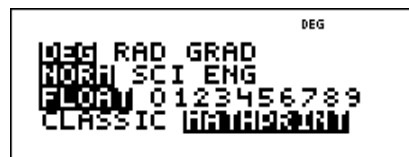

Viewing the statistics

Assuming that the rate of shoe sales is a constant, you can use two data points to predict the June sales of Brand A if we know the total June sales. Use a line of best fit to find the June sales of Brand A if the store sells a total of 32 pairs in June. Hint: Find $y'(32)$.

2nd **[stat]**



Press

Display

2nd **[stat]**



2 \downarrow \downarrow

enter

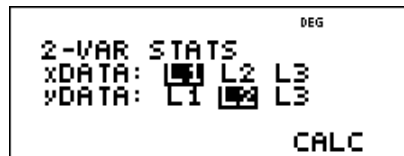

\downarrow (scroll down to y')

enter

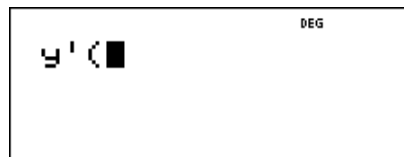

32 **)** **enter**

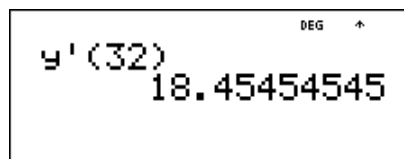

18 pairs of Brand A will be sold in June if the total sales are 32 pairs.

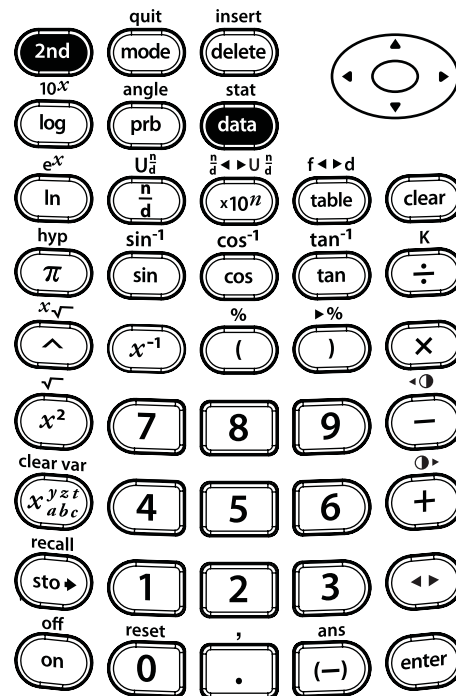

Keys

1. **prb** displays the following menu of functions.

- nPr** Calculates the number of possible permutations.
- nCr** Calculates the number of possible combinations.
- !** Calculates the factorial of a number.
- Rand** Generates a random number between 0 and 1.
- Randint(** Generates a random integer between 2 integers, A and B , where $A \leq \text{Randint} \leq B$.

Notes

- The examples on the transparency masters assume all default settings.
- A combination is an arrangement of objects in which the order is not important, as in a hand of cards.
- A permutation is an arrangement of objects in which the order is important, as in a race.
- A factorial is the product of all the positive integers from 1 to n , where n is a positive whole number ≤ 69 .
- You can store (**sto**) an integer to **Rand** just as you would store values to memory variables. If you wish to control the random numbers generated by all calculators in your class, have all students store the same number to **Rand**; the sequence of random numbers is then the same on all of the calculators.
- For **Randint**, use a comma to separate the 2 numbers that you specify.

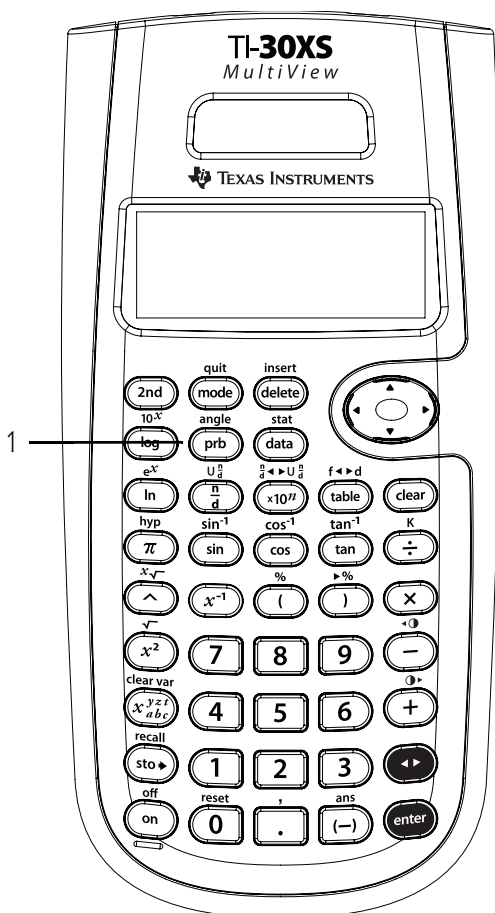

Combination (nCr)

You have space for 2 books on your bookshelf. You have 4 books to put on the shelf. Use this formula to find how many ways you could place the 4 books in the 2 spaces.

$$4 \text{ nCr } 2$$

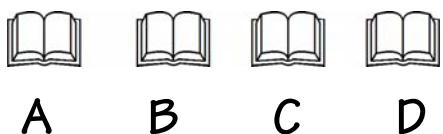

AB and BA
count as only 1
combination

AB	AC	AD
BA	BC	BD
CA	CB	CD
DA	DB	DC

Press

4 **prb**

Display



enter 2 **enter**

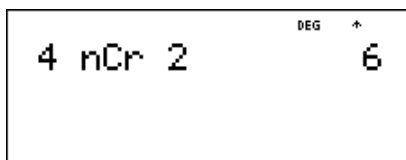

There are 6 unique combinations of 2 books chosen from 4 different books.

prb

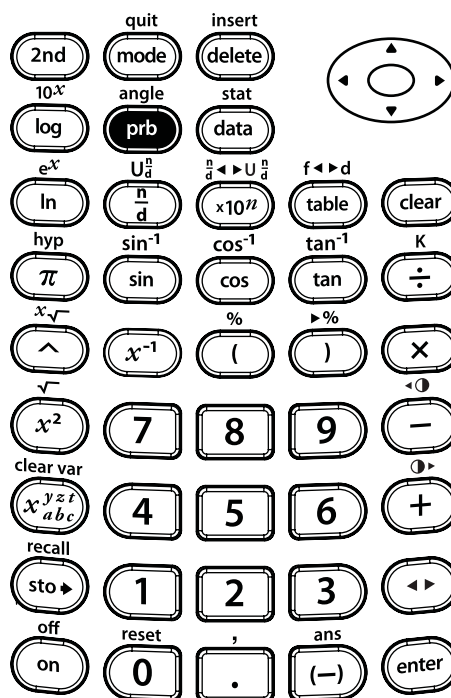
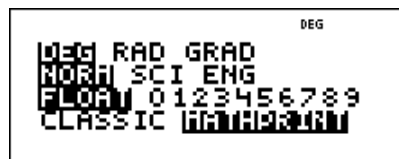

Permutation (nPr)

Four different people are running in a race. Use this formula to find how many different ways they can place 1st and 2nd.

$$4 \text{ nPr } 2$$

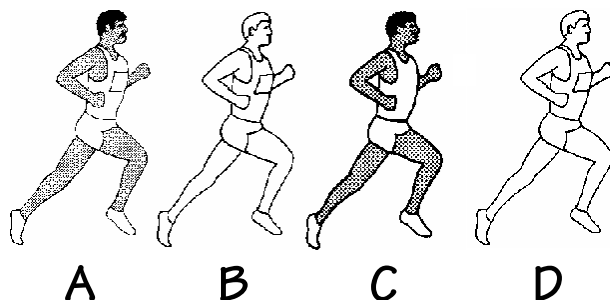

AB and BA	AB	AC	AD	
count as 2		BA	BC	BD
permutations		CA	CB	CD
		DA	DB	DC

Press

4 **prb**

enter 2 **enter**

Display

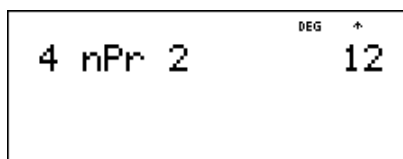
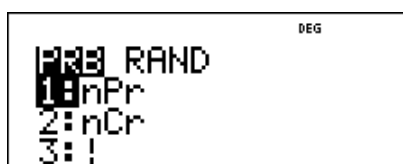

There are 12 different permutations for the 1st and 2nd place results of the race.

prb

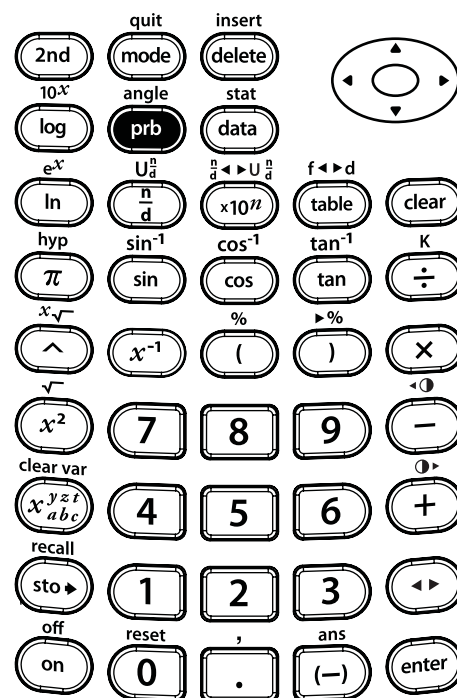

Factorial (!)

State license plates contain different numbers and letters to create a unique identification number for each car. Make your own license plates each containing a 4-digit number. Using the digits 1, 3, 7, and 9 without repetition, how many 4-digit numbers can you form?

You can use a tree diagram to create the following list of license plates. Are you sure you found them all?

Hint: Find 4!



1379	1397	1739	1793	1937	1973
3179	3197	3719	3791	3917	3971
7139	7193	7319	7391	7913	7931
9137	9173	9317	9371	9713	9731

Press

4 **prb**  

enter **enter**

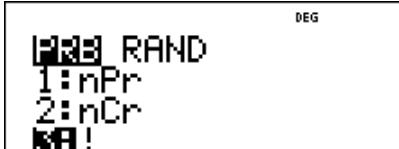
Display

You can make 24 unique license plates using 1, 3, 7 and 9 without repetition.

prb



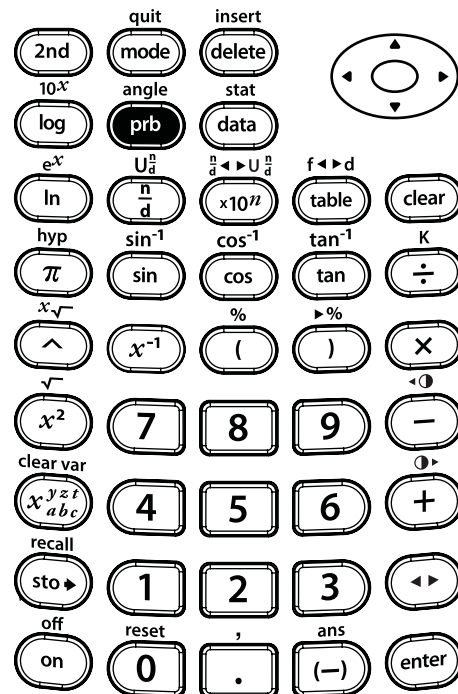

Random (rand)

Generate a sequence of random numbers.

Press

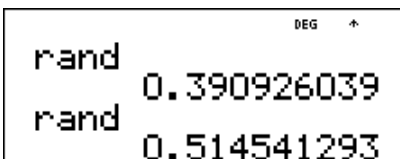
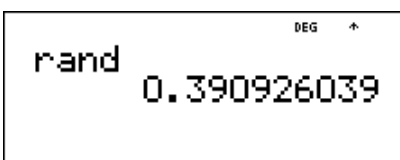
Display



Results will vary.

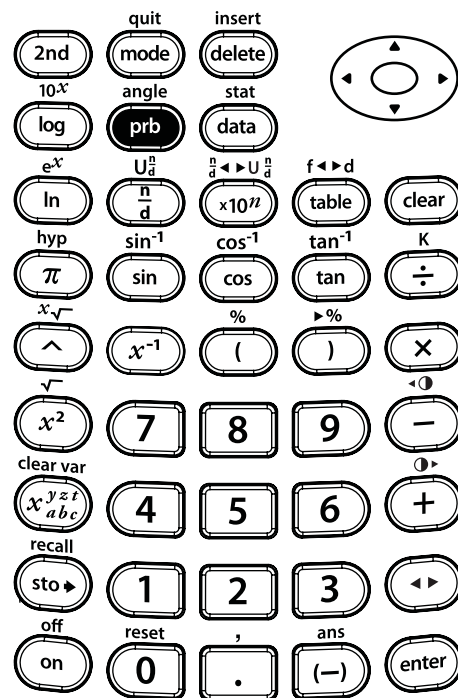

Setting a random (rand) seed

Set 1 as the current seed and generate a sequence of random numbers.

Press	Display
1 sto ▶ prb ▶ enter	1→rand DEG ↑
enter	1→rand DEG ↑ 1
prb ▶ enter	1→rand DEG ↑ 1 rand
enter	1→rand DEG ↑ 1 rand 0.000018633
enter	rand DEG ↑ 0.000018633 rand 0.745579721

Note: Your results will be the same as this example if you use the same number to store to random seed.

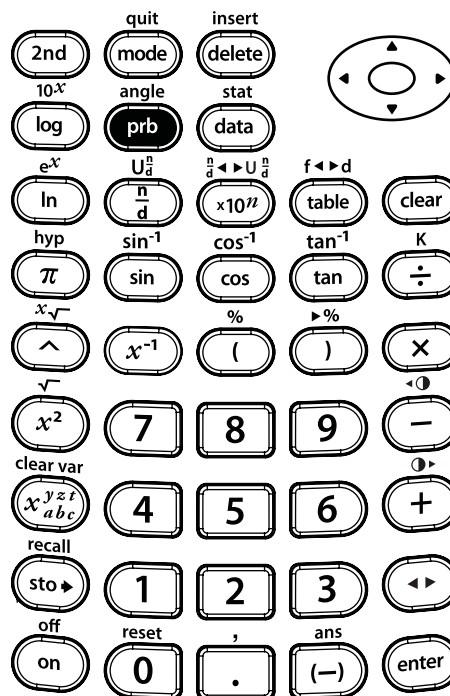

prb



Random integer (randint)

Create your own calculator spinner.
Your spinner will pick numbers from 2 through 10.

Hint: Generate a random integer from 2 through 10.

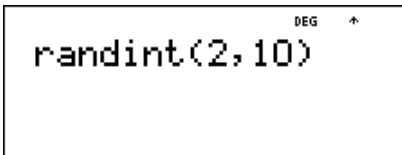
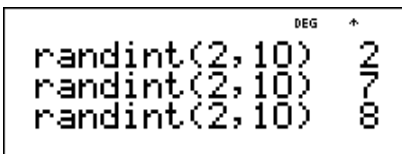
Press	Display
prb  	
enter 2 2nd [,] 10)	
enter enter enter	

Results will vary.

prb

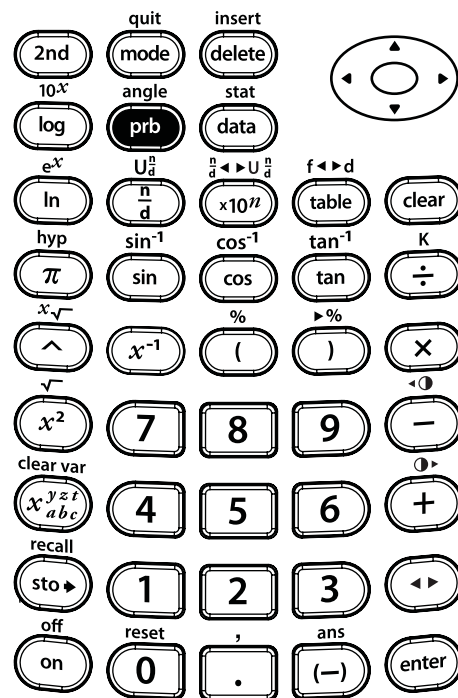
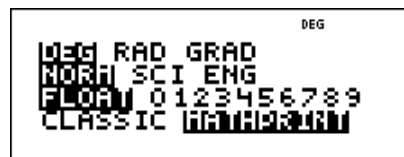

Keys

1. **table** allows you to display a defined function in a tabular form. To set up a function table:
 - a. Press **table**.
 - b. Enter a function in terms of x and press **enter**.
 - c. Select the start and step values, and auto or ask- x options, and press **enter**.

The table is displayed using the specified values.

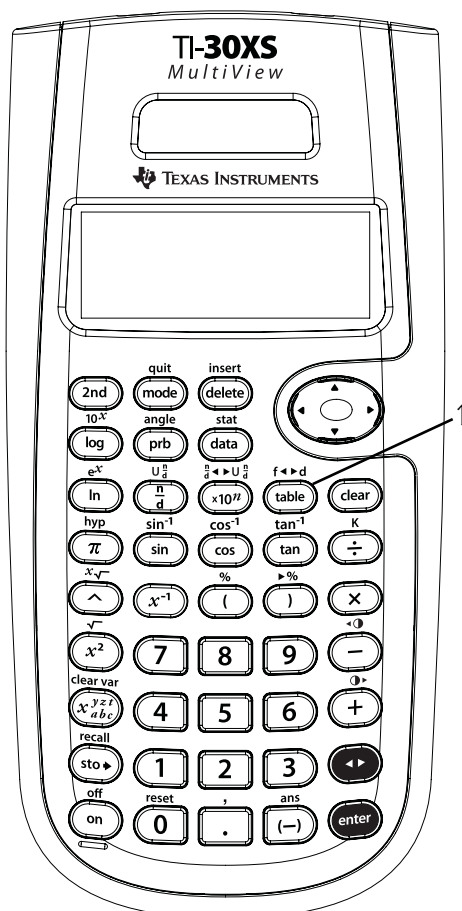

- The examples on the transparency masters assume all default settings.
- Enter the function (expression) at the $y=$ prompt. Functions can contain stacked fractions and most built-in functions such as sine, cosine, e^x , and so forth. Functions can not contain \leftarrow or the functions rand and randint.
- To change a value on the table setup screen, press **clear** and then enter a new value.
- Depending on the function and the step values, you may be able to affect the format (decimal or fraction) of the y values. When a decimal number (like 2.0) is used in the function or the step values, answers can be forced to decimal.
- To clear the table in ask- x , press **delete** on each entry.
- In ask- x , if you input a decimal, the x -value displays as a decimal. For example, if you enter 2π , the x -value displays 2π . If you enter 2.0π , the x -value displays 6.28319. If you enter a fraction using $\left[\frac{\square}{\square}\right]$, the x -value displays as a fraction.
- Press **clear** to back up screens within the function table.
- The TI-30XS MultiView™ calculator retains the last entered function in memory when you quit the function table application (**2nd**[quit]).

Notes

Using auto

Find the vertex of the parabola $y = x(36 - x)$ using a table of values.

Reminder: The vertex of the parabola is a point on the line of symmetry of the parabola. Notice that $(0, 0)$ and $(36, 0)$ are x -intercepts and the parabola is open (concave) down. The vertex will be between $x = 0$ and $x = 36$.

Press

Display

table x^{yzt} _{abc} (
 36 x^{yzt} _{abc} -
) **enter**

$y = x(36 - x)$ DEG +

0 \downarrow 4 \downarrow
 enter \downarrow

Start=0 DEG
 Step=4
 Auto Ask-x OK

enter \downarrow \downarrow \downarrow
 \downarrow \downarrow

x	y
12	288
16	320
20	320

x=20 DEG

Notice that the vertex must be between $x = 16$ and $x = 20$ since the y -values are the same. The y -values must be increasing and decreasing for $x = 16$ to $x = 20$.

table

```

DEG RAD GRAD
NORM SCI ENG
FLOAT 0123456789
CLASSIC MATHWDRN
    
```

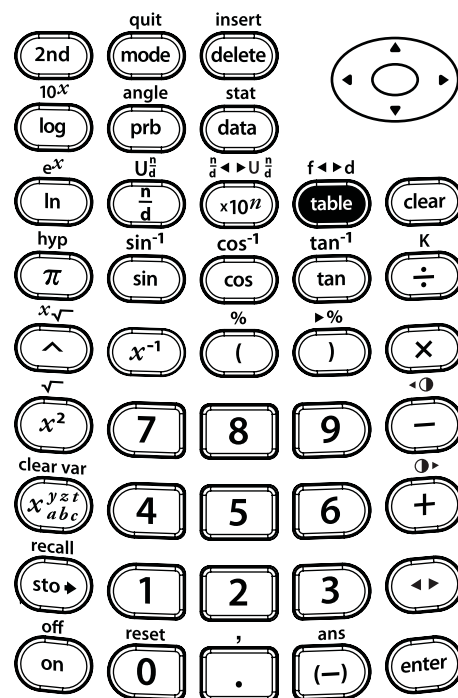

Using auto (Continued)

clear 15 \downarrow 1
 \downarrow \downarrow

```

DEG
Start=15
Step=1
Auto Ask-x
OK
    
```

enter \downarrow \downarrow
 \downarrow \downarrow

```

DEG  ↑
  x  |  y
17  |  323
18  |  324
19  |  323
x=19
    
```

table

```

DEG
MODE RAD GRAD
NORM SCI ENG
FLOA 0 123456789
CLASSIC W H H A R R
    
```

On your own:

Start at 17 and change the step size to 0.25. What happens around $x = 18$? Can you locate the vertex? Why?

After searching close to $x = 18$, the point $(18, 324)$ appears to be the vertex of the parabola since it appears to be the turning point of the set of points of this function.

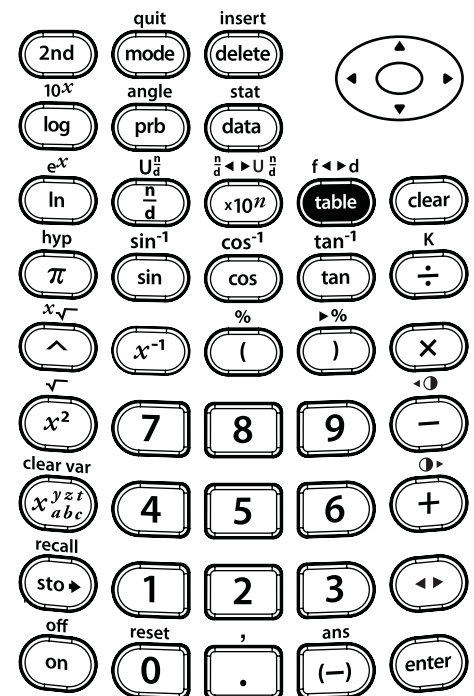

Keys

1. x^2 squares the value.
2. 2^{nd} $\sqrt{}$ calculates the square root.
3. 2^{nd} $[x\sqrt{}]$ calculates the specified root (x) of the value.
4. x^{-1} calculates the reciprocal.
5. \wedge raises a value to a specified power.

Notes

- The examples on the transparency masters assume all default settings.
- To use \wedge , enter the base, press \wedge , and then enter the exponent.
- In Classic mode, exponentiation using the \wedge key is evaluated from left to right. The expression 2^3^2 is evaluated as $(2^3)^2$, with the result of 64.

In MathPrint™ mode, exponentiation using the \wedge key is evaluated from right to left.

Pressing $2 \wedge 3 \wedge 2$ displays as 2^{3^2} , with the result of 512.

- The result of calculations with \wedge must be within the range of the TI-30XS MultiView™ calculator.
- The TI-30 MultiView calculator evaluates expressions entered with x^2 and x^{-1} from left to right in both Classic and MathPrint modes. Pressing $3 x^2 x^2$ displays as 3^{22} . This is calculated as $(3^2)^2 = 81$.
- The base and the exponent may be either positive or negative. Refer to Domain under Error Messages in Appendix C for restrictions.
- Use parentheses where needed to obtain the desired results.

Example: $-5^2 = -25$
 $(-5)^2 = 25$

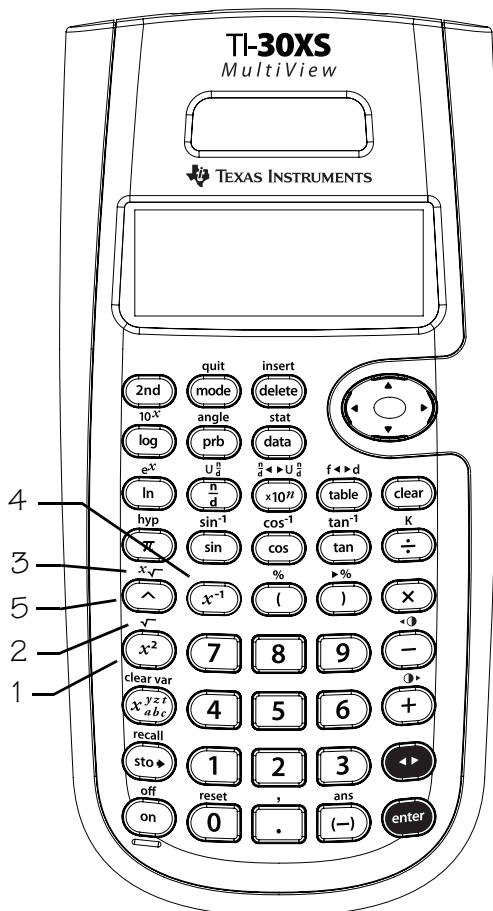

Squares

Use this formula to find the size of the tarpaulin needed to cover the entire baseball infield.

$$A = x^2 = 27.4^2 \text{ square meters}$$

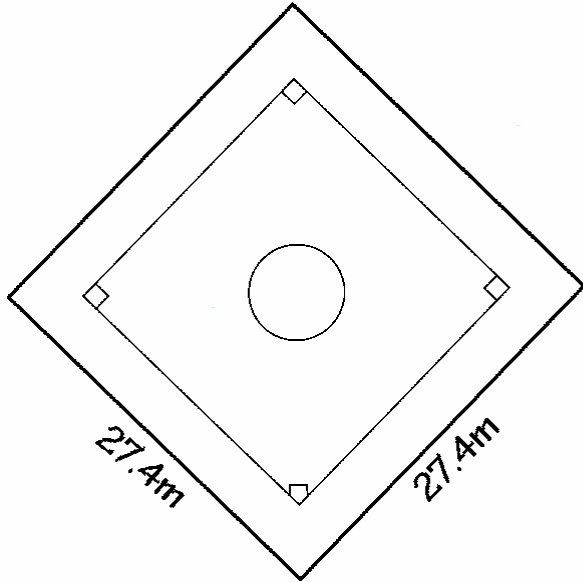

Press

27 \square 4
 \square x^2 **enter**

or

27 \square 4 \square \wedge
 2 **enter**

Display

27.4² 750.76 DEG $\uparrow\downarrow$

27.4² 750.76 DEG $\uparrow\downarrow$

The area of the tarpaulin is 750.76 square meters.

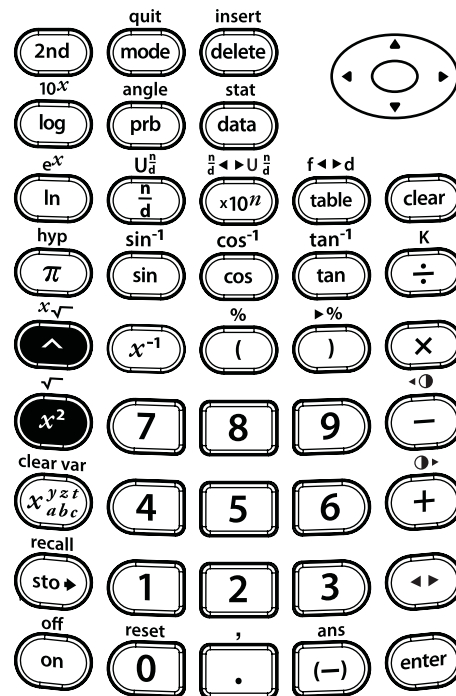
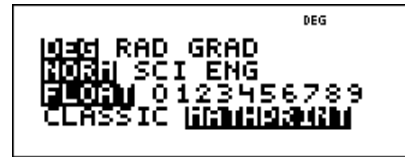

Square roots

Use this formula to find the length of the side of a square clubhouse if 3m^2 of carpet would cover the floor. Round your answer to 0 decimal places.

$$L = \sqrt{x} = \sqrt{3} \text{ meters}$$

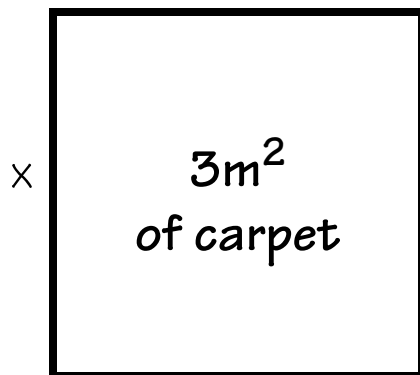

Press

Display

2nd **[√]** 3 **enter**

$\sqrt{3}$ DEG $\sqrt{3}$



$\sqrt{3}$ DEG $\sqrt{3}$
 $\sqrt{3}$ 1.732050808

mode

enter

clear **enter**

FIX DEG $\sqrt{3}$ DEG $\sqrt{3}$
 $\sqrt{3}$ 1.732050808
 $\sqrt{3}$ 2

The length of a side of the square clubhouse is 2 meters rounded to 0 decimal places.

2nd **[√]**

FIX DEG
MODE RAD GRAD
NORMAL SCI ENG
FLOAT 0 123456789
CLASSIC

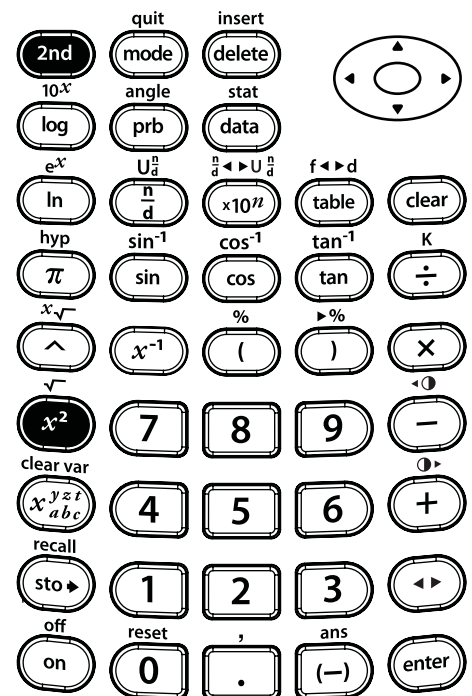

Cubes

Use this formula to find the volume of a cube with sides 2.3 meters long. Change your answer to a fraction.

$$V = L^3 = 2.3^3 \text{ cubic meters}$$

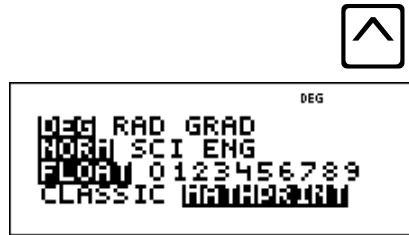
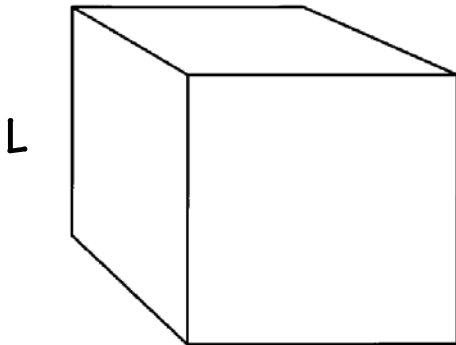

Press

Display

2 \square 3 \wedge
3 **enter**

2.3³ 12.167

$\leftarrow \rightarrow$

2.3³ 12.167
12.167 \rightarrow
12167
1000

The volume of the cube is 12.167 cubic meters.

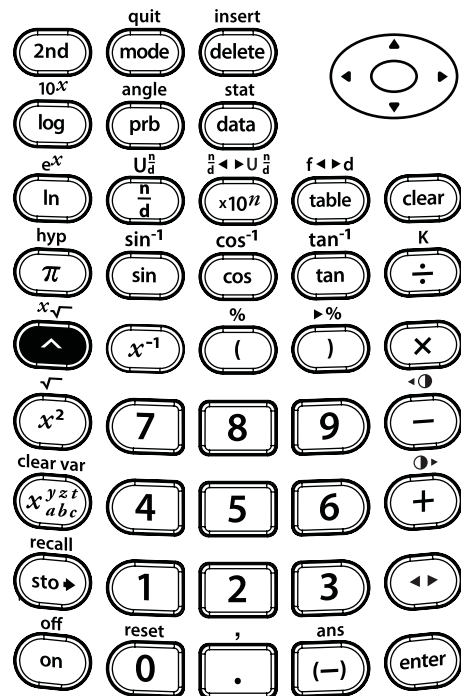

Powers

Fold a piece of paper in half, in half again, and so on until you cannot physically fold it in half again. How many sections would there be after 10 folds? After 15 folds?

Press	Display
2 \square^{\wedge} 10 enter	2^{10} 1024
2 \square^{\wedge} 15 enter	2^{15} 32768

Fold the paper in half once and you will see two sections. Fold the paper in half again and you will see four sections. Folding again yields 8 sections, and so on. After 10 folds there will be 1,024 sections. After 15 folds, there will be 32,768 sections!

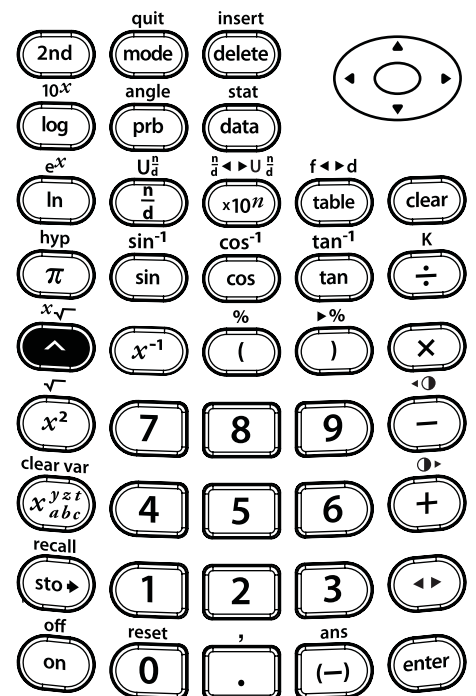
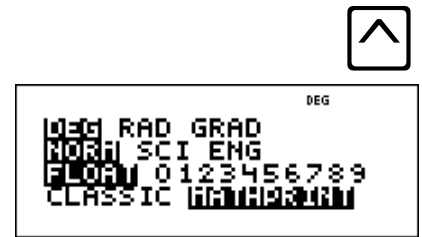

Roots

If the volume of a cube is 125 cm^3 ,
what is the length of each side?

$$L = \sqrt[3]{125} \text{ cm}$$

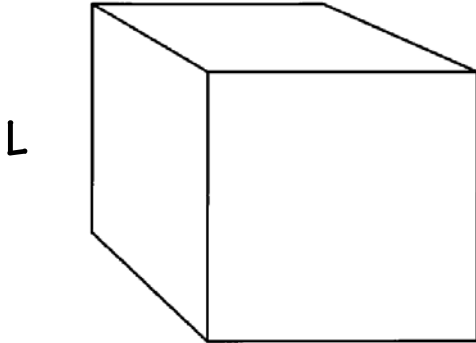

Press

3 **2nd** [$x\sqrt{\quad}$]
125 **enter**

Display

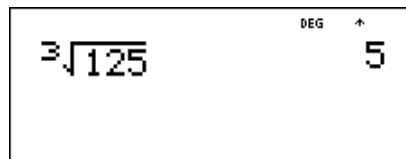

The length of each side is 5 cm.

2nd [$x\sqrt{\quad}$]

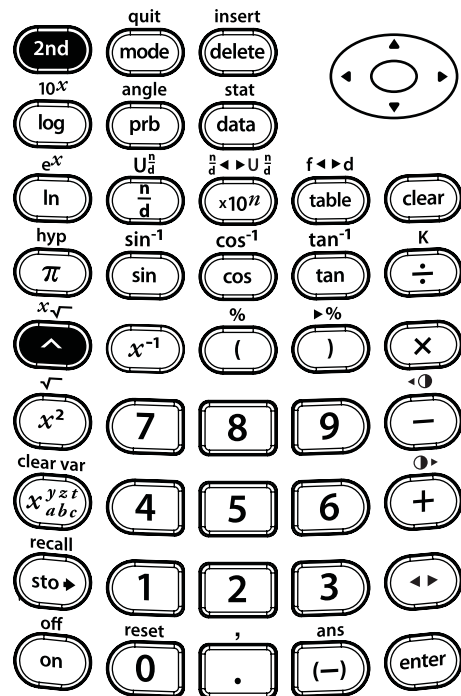

Reciprocals

The chart below shows the amount of time spent building model ships.

<u>Ships</u>	<u>Time Spent Building</u>	<u>Portion Completed Per Hour</u>
Sailing	10 hrs.	?
Steam	5 hrs.	?
Luxury	5 $\frac{1}{3}$ hrs.	?

How much of each model was completed per hour?

Press Display

Sailing ship:

10 x^{-1} **enter**



Steam ship:

5 x^{-1} **enter**

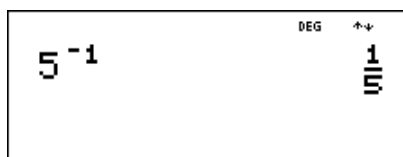

Luxury liner:

5 **2nd** **[Uⁿ/_d]** 1 **▼**
 3 **▶** **enter**
 x^{-1} **enter**

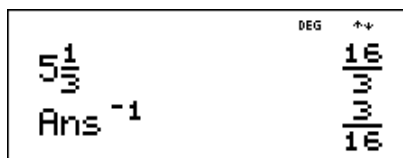

x^{-1}

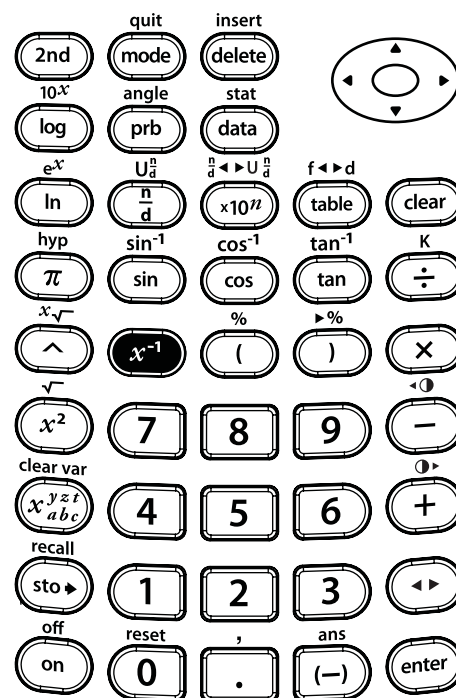
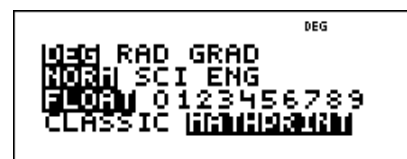

Keys

1. **log** calculates the common logarithm (base 10).
2. **2nd** **[10^x]** calculates 10 raised to the power of the value entered as the exponent (common antilogarithm).
3. **ln** calculates the natural logarithm (base e , where $e \approx 2.718281828459$).
4. **2nd** **[e^x]** calculates e raised to the power of the value entered as the exponent (natural antilogarithm).

Notes

- The examples on the transparency masters assume all default settings.
- **]** ends a logarithmic function.
- In MathPrint™ mode, press **⏏** to exit the exponent function.

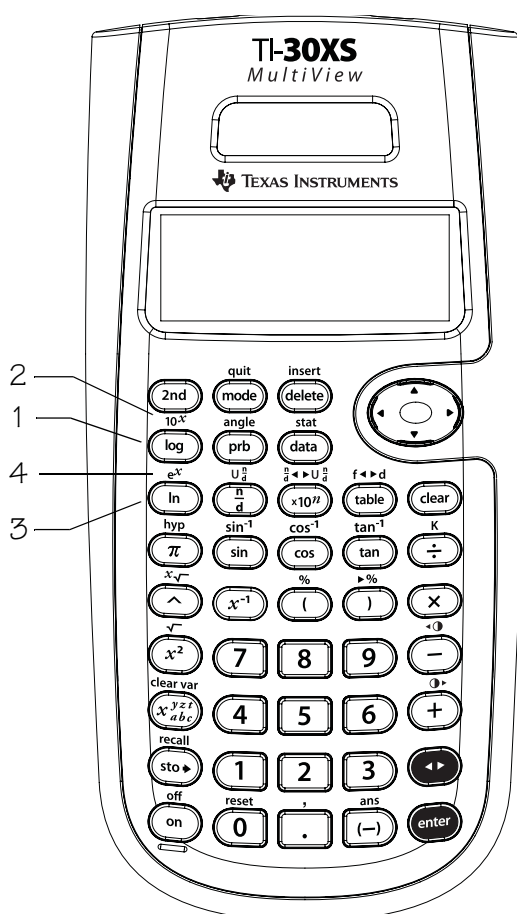

Common logarithm, natural logarithm

Find $\log 23$ rounded to 4 decimal places. Then find $\ln 23$ rounded to 4 decimal places and return to floating decimal notation.

Press	Display
log 23) enter	DEG + log(23) 1.361727836
mode \downarrow \downarrow \rightarrow \rightarrow \rightarrow \rightarrow \rightarrow enter clear enter	FIX DEG DEG RAD GRAD NORM SCI ENG FLOAT 0 123456789 CLASSIC MATH PRN
ln 23) enter	FIX DEG + log(23) 1.361727836 log(23) 1.3617 ln(23) 3.1355
mode \downarrow \downarrow enter clear enter	DEG DEG RAD GRAD NORM SCI ENG FLOAT 0 123456789 CLASSIC MATH PRN
clear enter	DEG + log(23) 1.3617 ln(23) 3.1355 ln(23) 3.135494216

log **ln**

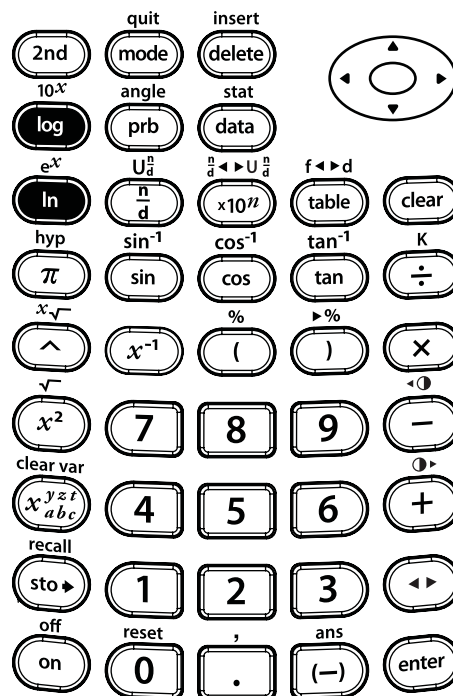
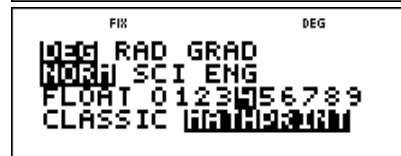
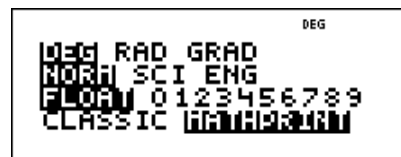

Common antilogarithm, natural antilogarithm

Find antilog 3.9824 rounded to 4 decimal places. Then find antiln 3.9824 rounded to 4 decimal places. When finished, return to floating decimal notation.

2nd **[10^x]**
2nd **[e^x]**

Press

Display

2nd **[10^x]** 3 **.**
 9824 **enter**

DEG \leftrightarrow
 $10^{3.9824}$
 9602.846792

mode \downarrow \downarrow
 \rightarrow \rightarrow \rightarrow \rightarrow
 \rightarrow **enter**

FIX DEG
 MODE RAD GRAD
 NORM SCI ENG
 FLOAT 0 1 2 3 4 5 6 7 8 9
 CLASSIC **FIX** **FIX**

clear **enter**

FIX DEG \leftrightarrow
 $10^{3.9824}$ 9602.846792
 9602.8468

2nd **[e^x]** 3 **.**
 9824 **enter**

FIX DEG \leftrightarrow
 $10^{3.9824}$ 9602.8468
 $e^{3.9824}$ 53.6456

mode \downarrow
 \downarrow **enter**

DEG
 MODE RAD GRAD
 NORM SCI ENG
 FLOAT 0 1 2 3 4 5 6 7 8 9
 CLASSIC **FIX** **FIX**

clear **enter**

DEG \leftrightarrow
 $e^{3.9824}$ 53.6456
 $e^{3.9824}$ 53.64562936

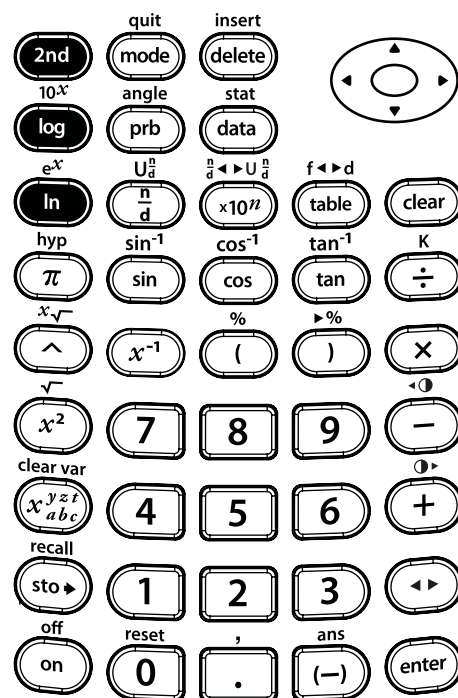

Keys

1. π displays the value of pi rounded to 10 digits (3.141592654).

Notes

- The examples on the transparency masters assume all default settings.
- In MathPrint™ mode, include a decimal number inside the expression with pi to receive a decimal output. For example, if you enter 2π , the TI-30XS MultiView™ calculator displays 2π . If you enter 2.0π , the calculator displays the decimal version, 6.28319.
- You can use \blacktriangleleft to toggle the answer between decimal and pi formats.
- Internally, pi is stored to 13 digits (3.141592653590).
- You can select the number of decimal places from the mode menu.

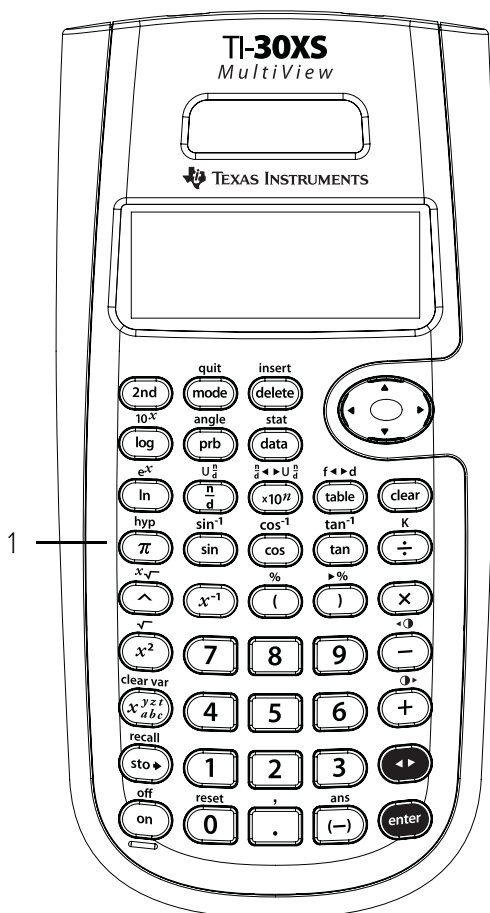

Circumference

Use this formula to find the amount of border you need if you want to put a circular border all the way around the tree.

$$C = 2\pi r = 2 \times \pi \times 1.5\text{m}$$

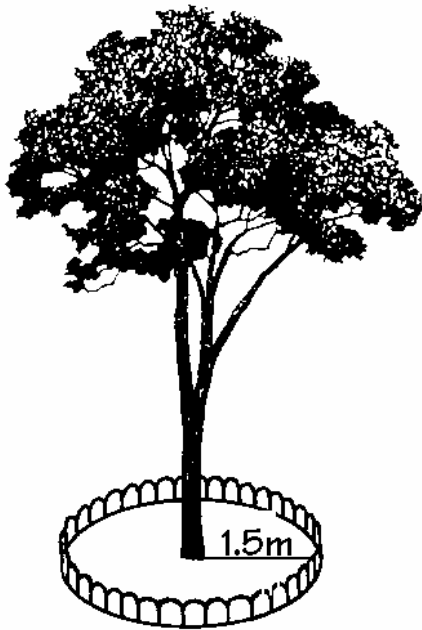

Press

2 \times π \times
1 \cdot 5 **enter**



Display

DEG \leftrightarrow

2* π *1.5
9.424777961

DEG \leftrightarrow

2* π *1.5
9.424777961
9.42477796077*
3 π

The border length is 3π m. You will need approximately 9.4 m for the border.

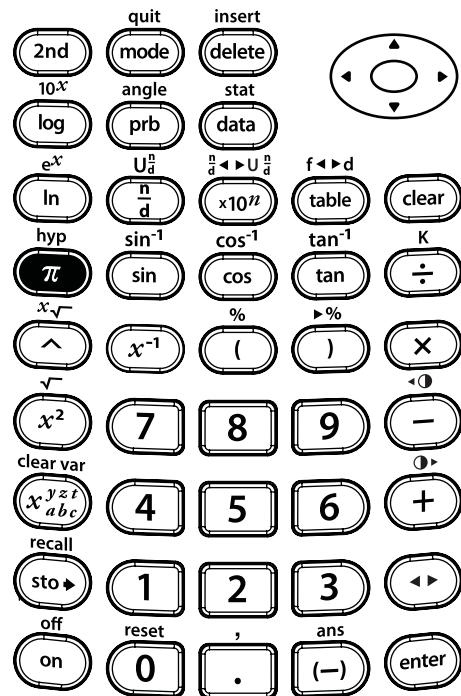

Area

Use this formula to find how much of a lawn would be covered by the sprinkler. Round your answer to the nearest whole number, and then return to floating decimal mode.

$$A = \pi r^2 = \pi \times 4^2 \text{ square meters}$$

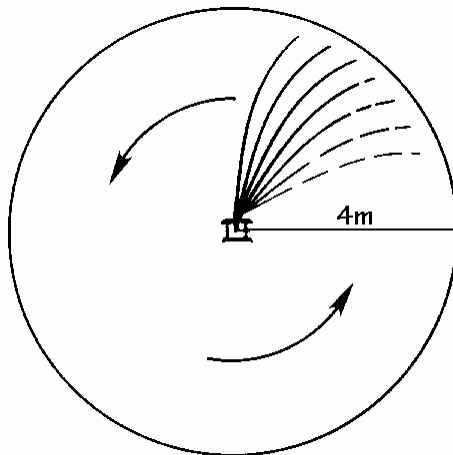

Press

π \times 4
 x^2 **enter**

mode \downarrow \downarrow \rightarrow
enter **clear**

\leftarrow

Display

```

DEG  +
pi*4^2  16pi
    
```

```

FIX  DEG
DEG RAD GRD
NORM SCI ENG
FLOAT 0123456789
CLASSIC MATHMATH
    
```

```

FIX  DEG  +
pi*4^2  16pi
16pi+  50
    
```



```

DEG  DEG
DEG RAD GRD
NORM SCI ENG
FLOAT 0123456789
CLASSIC MATHMATH
    
```

```

FIX  DEG
DEG RAD GRD
NORM SCI ENG
FLOAT 0123456789
CLASSIC MATHMATH
    
```

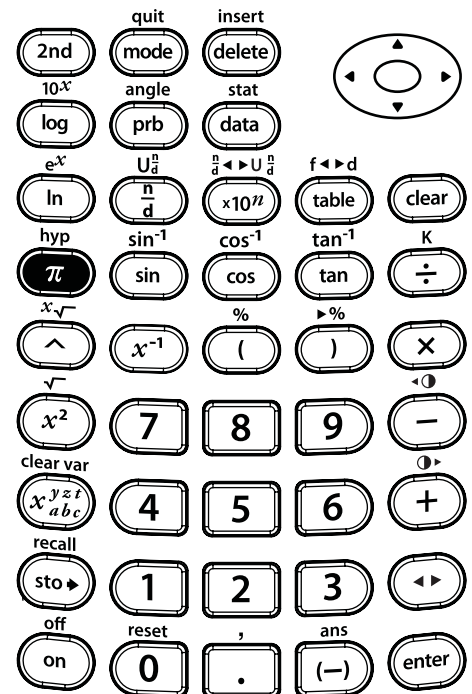

Area (Continued)

mode  

enter clear

enter

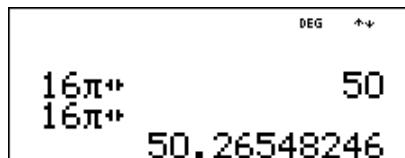

The area that will be covered by the sprinkler is approximately 50 square meters.

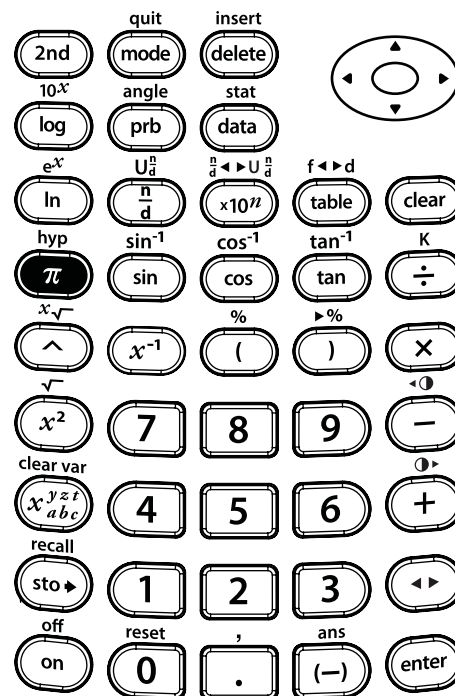

Keys

1. **2nd**[angle] displays a choice of two submenus that enable you to specify the angle unit modifier as degrees ($^{\circ}$), minutes ($'$), seconds ($''$); radian (r); gradian (g), or convert units using **DMS**. You can also convert between rectangular coordinate form (R) and polar coordinate form (P). (See Chapter 18, Polar and rectangular conversions, for more information.)

Choose an angle mode from the mode screen. You can choose from DEG (default), RAD, or GRAD. Entries are interpreted and results displayed according to the angle mode setting without the need to enter an angle unit modifier.

If you specify an angle unit modifier from the Angle menu, the calculation is performed in that angle type, but the result will be given in the angle mode setting.

Notes

- The examples on the transparency masters assume all default settings.
- **DMS** angles are entered as $^{\circ}$ (degrees), $'$ (minutes), and $''$ (seconds).

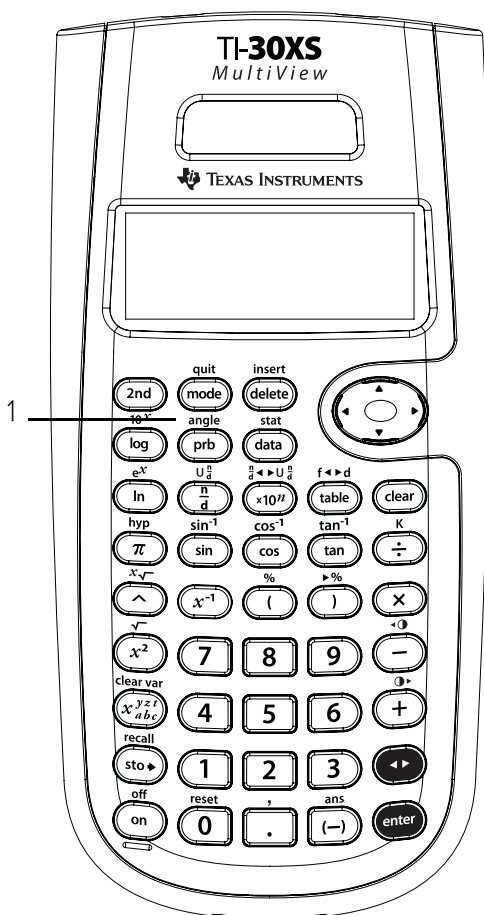

Degrees, minutes, and seconds to decimal

Find the measure of the third angle of a triangle if one angle measures $45^\circ 30'$ and the other angle measures $36^\circ 15'$. Express the angle measure in degrees, minutes, and seconds.

Press	Display
45 2nd [angle] 1	
30 2nd [angle] 2 + 36 2nd [angle] 1	
15 2nd [angle] 2 enter	
180 2nd [angle] 1 - 2nd [ans] enter	
2nd [angle] 6 enter	

The measure of the third angle is $98^\circ 15'$.

2nd [angle]

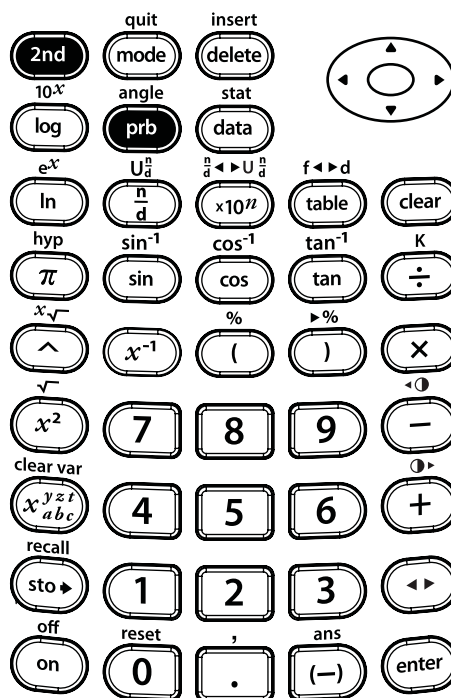
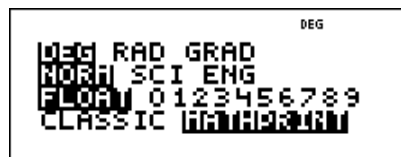

Decimal to degrees, minutes, and seconds

You are visiting Beijing, China. Your GPS gives your location (latitude and longitude) as 39.55° N 116.20° E. Change your location information to degrees, minutes and seconds.

Press	Display
39.55 2nd [angle] enter 2nd [angle] \blacktriangle enter enter	
116.20 2nd [angle] enter 2nd [angle] \blacktriangle enter enter	

Your location in Beijing, China is $39^\circ 33'$ N $116^\circ 12'$ E.

2nd **[angle]**

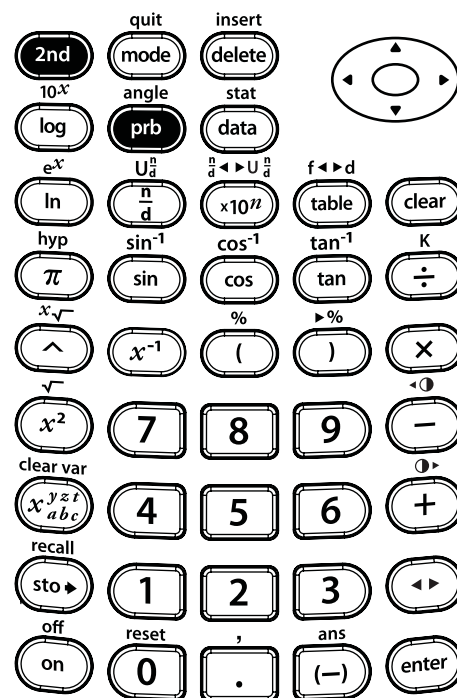

Degrees, radians, and gradians

Calculate the following:

$$\cos(180 \text{ degrees})$$

$$\cos(\pi \text{ radians})$$

$$\cos(200 \text{ grad})$$

Remember:

$$180 \text{ degrees} = \pi \text{ radians} = 200 \text{ grad.}$$

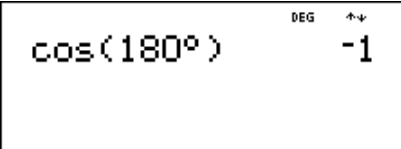
Press	Display
cos 180 2nd [angle] 1) enter	

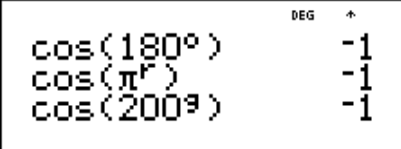
cos π 2nd [angle] 4) enter	
--------------------------------------------------------------------------	------------------------------------------------------------------------------------

cos 200 2nd [angle] 5) enter	
------------------------------------------------------------------------	-------------------------------------------------------------------------------------

2nd **[angle]**

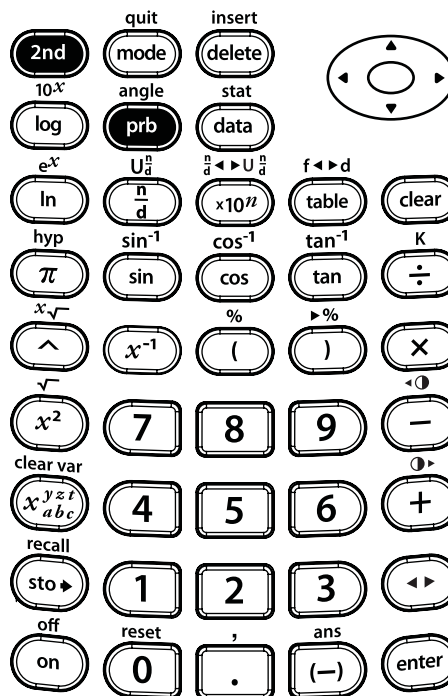

Keys

1. **2nd****[angle]** displays the choice of two submenus that let you convert rectangular coordinates (x,y) to polar coordinates (r,θ) or vice versa. You can also specify the angle unit modifier. (See Chapter 17, Angle settings and conversions, for more information.)

R \blacktriangleright **Pr**(Converts rectangular coordinate to polar coordinate r .

R \blacktriangleright **P** θ (Converts rectangular coordinate to polar coordinate θ .

P \blacktriangleright **R****x**(Converts polar coordinate to rectangular coordinate x .

P \blacktriangleright **R****y**(Converts polar coordinate to rectangular coordinate y .

2. **2nd** **[,]** enters a comma.

Notes

- The example on the transparency master assumes all default settings.
- Before starting calculations, set the angle mode as necessary.

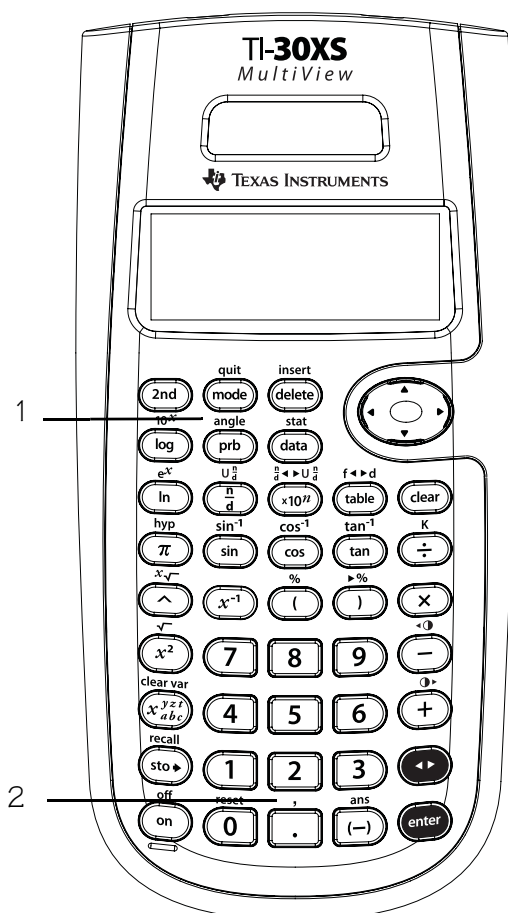

Polar to rectangular

Convert the polar ordered pair $(7, 30^\circ)$ to rectangular coordinates.

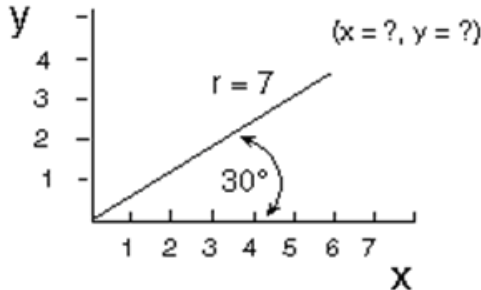

2nd **[angle]**

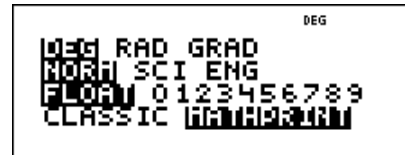

Press

Display

2nd **[angle]** **[▶]**



[▼] **[▼]**

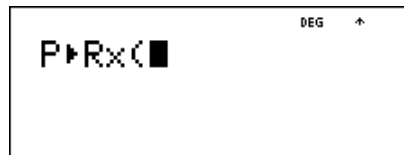

enter 7 **2nd** **[,]**
30 **)** **enter**

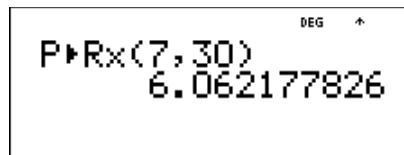

2nd **[angle]** **[▶]**

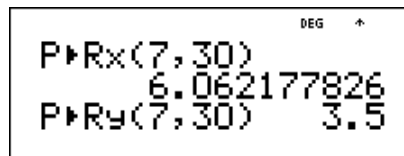

[▼] **[▼]** **[▼]** **enter**

7 **2nd** **[,]** 30

) **enter**

The rectangular ordered pair is $(x, y) = (6.062177826, 3.5)$

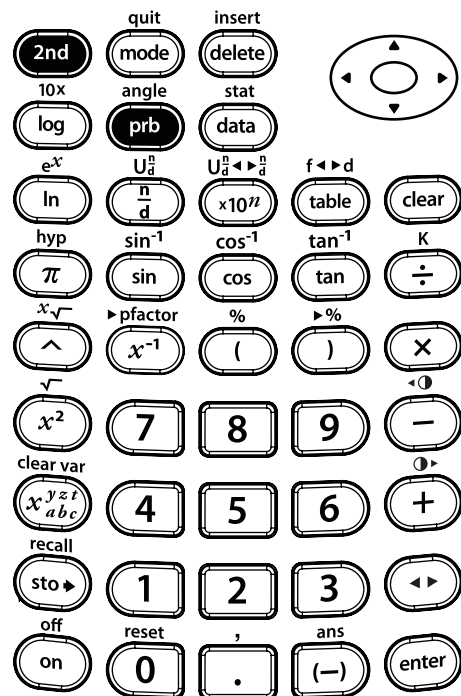

Keys

1. **[sin]** calculates the sine of an angle.
2. **[2nd] [sin⁻¹]** calculates the inverse sine.
3. **[cos]** calculates the cosine of an angle.
4. **[2nd] [cos⁻¹]** calculates the inverse cosine.
5. **[tan]** calculates the tangent of an angle.
6. **[2nd] [tan⁻¹]** calculates the inverse tangent.

Notes

- The examples on the transparency masters assume all default settings.
- Before starting a trigonometric calculation, be sure to select the appropriate angle mode setting (**DEG**, **RAD**, or **GRAD**—See Chapter 17, Angle settings and conversions). The calculator interprets values according to the current angle-unit mode setting.
- In MathPrint™ mode and the corresponding mode setting of DEG or RAD, evaluating trigonometric functions at multiples of 15 degree or pi/12 increments yields exact radical output in many cases.
- **[)]** closes the argument of a trigonometric function.

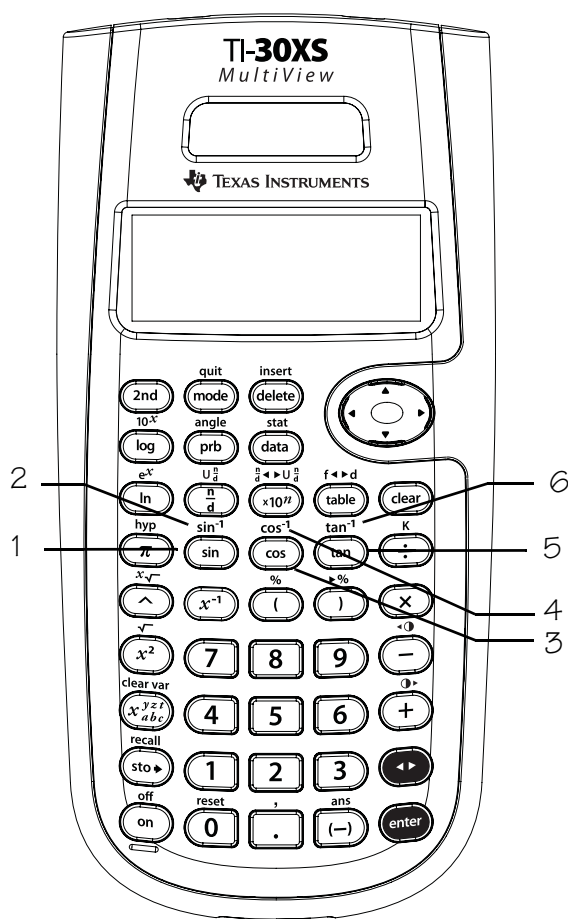

Tangent

Use this formula to find the distance from the lighthouse to the boat. Round your answer to the nearest whole number, and then return to floating decimal mode.

$$D = \frac{78}{\tan 27}$$

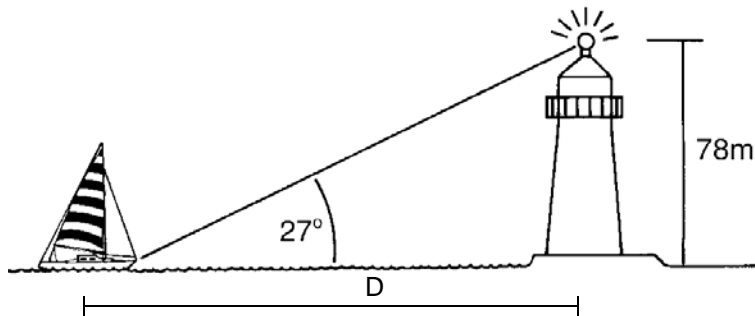

Press

Display

78 $\frac{n}{d}$ tan 27

2nd [angle] **enter**

) **enter**

mode \downarrow \downarrow

\blacktriangleright **enter**

clear **enter**

mode \downarrow \downarrow **enter**

clear **enter**

```

DEG  ↑↓
  78
tan(27°)
153.0836194
    
```

```

FIX      DEG
|DEG| RAD |GRAD|
|NOR| SCI |ENG|
|FLOAT| 0|123456789|
|CLASSIC| WAVE
    
```

```

FIX      DEG  ↑↓
tan(27°)
153.0836194
  78
tan(27°)
153
    
```

```

DEG  ↑↓
tan(27°)
  78
tan(27°)
153.0836194
    
```

The distance from the lighthouse to the boat is approximately 153 m.

tan

```

FIX      DEG
|DEG| RAD |GRAD|
|NOR| SCI |ENG|
|FLOAT| 0|123456789|
|CLASSIC| WAVE
    
```

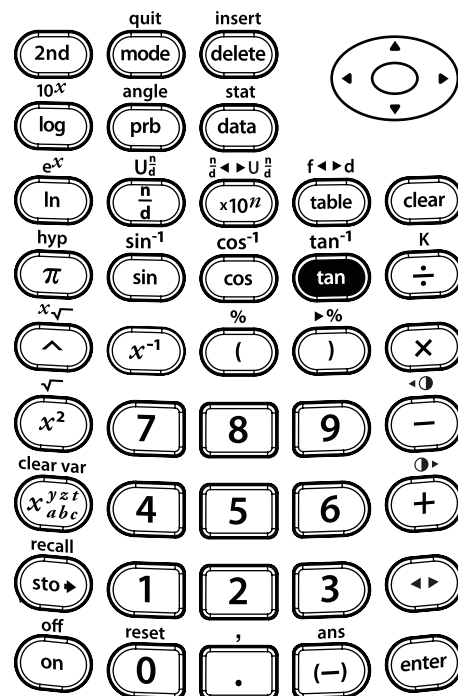

Inverse tangent

Use this formula to find the angle of depression, x . Round your answer to the nearest tenth, and then return to floating decimal mode.

$$x = \text{TAN}^{-1} \frac{600}{2500}$$

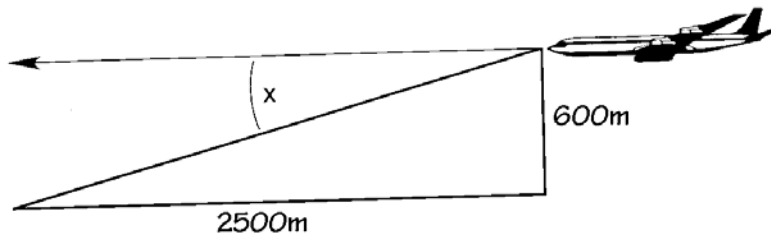

Press

Display

2nd **[tan⁻¹]** 600

[n/d] 2500 **[▶]**

) **enter**

mode **[▼]** **[▼]** **[▶]**

[▶] **enter**

clear **enter**

mode **[▼]** **[▼]**

enter **clear** **enter**

```

DEG  +-
tan-1( 600 / 2500 )
13.49573328
    
```

```

FIX  DEG  +-
MODE RAD GRAD
MODE SCI ENG
FLOAT 0 1 2 3 4 5 6 7 8 9
CLASSIC 1 2 3 4 5 6 7 8 9
    
```

```

FIX  DEG  +-
var1 '( 2500 )
13.49573328
tan-1( 600 / 2500 ) 13.5
    
```

```

DEG  +-  ---
var1 '( 2500 )
tan-1( 600 / 2500 )
13.49573328
    
```

2nd **[tan⁻¹]**

```

FIX  DEG
MODE RAD GRAD
MODE SCI ENG
FLOAT 0 1 2 3 4 5 6 7 8 9
CLASSIC 1 2 3 4 5 6 7 8 9
    
```

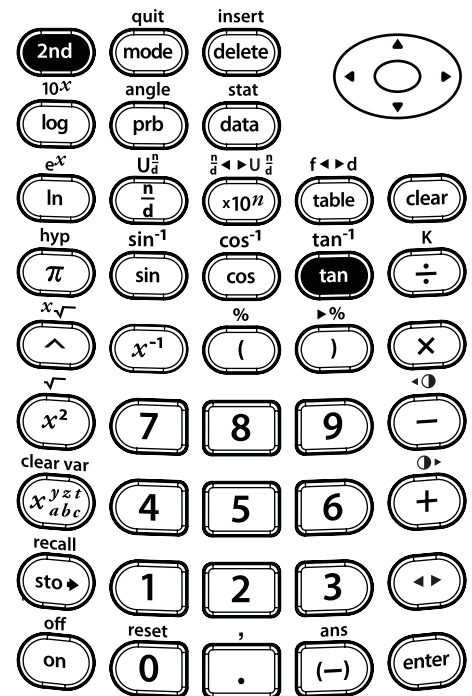

The angle of depression is $x = 13.5^\circ$ rounded to the nearest tenth.

Cosine

Use this formula to find the distance, D , from the base of the ladder to the house. Round your answer to the nearest whole number, and then return to floating decimal mode.

$$D = 5 \times \cos(74) \text{ meters}$$

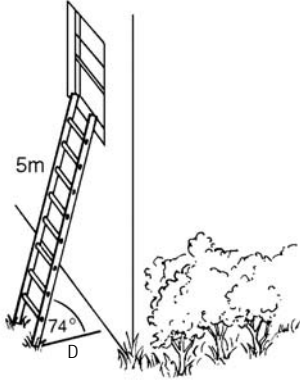

Press

Display

5 \times \cos 74
 \rightarrow **enter**

```

                    DEG
5*cos(74)
1.378186779
    
```

mode \downarrow \downarrow
 \rightarrow **enter**

```

                    FIX          DEG
MODE RAD GRAD
NORM SCI ENG
FLOAT 0 123456789
CLASSIC PRINT
    
```

clear **enter**

```

                    FIX          DEG
5*cos(74)
1.378186779
5*cos(74)
1
    
```

mode \downarrow \downarrow
enter **clear** **enter**

```

                    DEG
1.378186779
5*cos(74)
1
5*cos(74)
1.378186779
    
```

The distance is approximately 1 meter.

COS

```

                    FIX          DEG
MODE RAD GRAD
NORM SCI ENG
FLOAT 0 123456789
CLASSIC PRINT
    
```

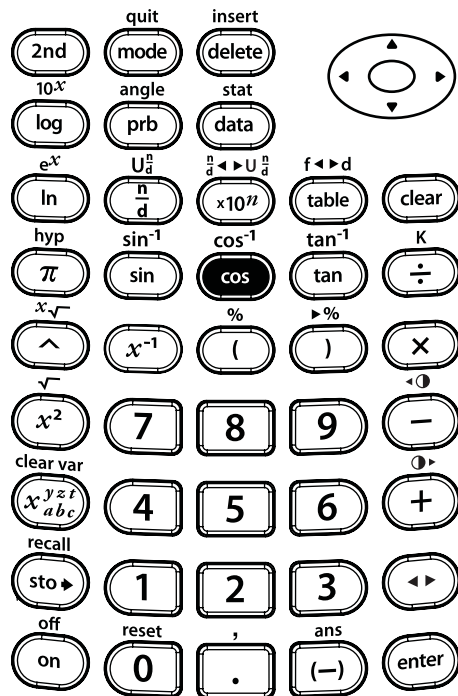

Inverse cosine

Use this formula to find the angle of the ski jump, x . Round your answer to the nearest tenth, and then return to floating decimal mode.

$$x = \cos^{-1} \frac{453}{500}$$

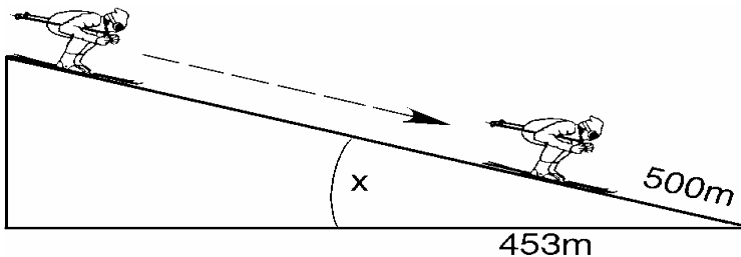

Press

Display

2nd **[cos⁻¹]** 453

[n/d] 500 **[▶]**

) **enter**

mode **[▼]** **[▼]** **[▶]**

[▶] **enter**

clear **enter**

mode **[▼]** **[▼]**

enter **clear** **enter**

```

DEG  ↑↓
cos-1(453)
      500
25.04169519
    
```

```

FIX      DEG  ↑↓
MODE RAD GRAD
MODE SCI ENG
FLOAT 0 1 2 3 4 5 6 7 8 9
CLASSIC 1 2 3 4 5 6 7 8 9
    
```

```

FIX      DEG  ↑↓
COS> '(500)
      25.04169519
cos-1(453) 25.0
      500
    
```

```

DEG  ↑↓
COS> '(500)
      -----
cos-1(453)
      25.04169519
    
```

The angle of the ski jump is $x = 25.0^\circ$ rounded to the nearest tenth.

2nd **[cos⁻¹]**

```

FIX      DEG
MODE RAD GRAD
MODE SCI ENG
FLOAT 0 1 2 3 4 5 6 7 8 9
CLASSIC 1 2 3 4 5 6 7 8 9
    
```

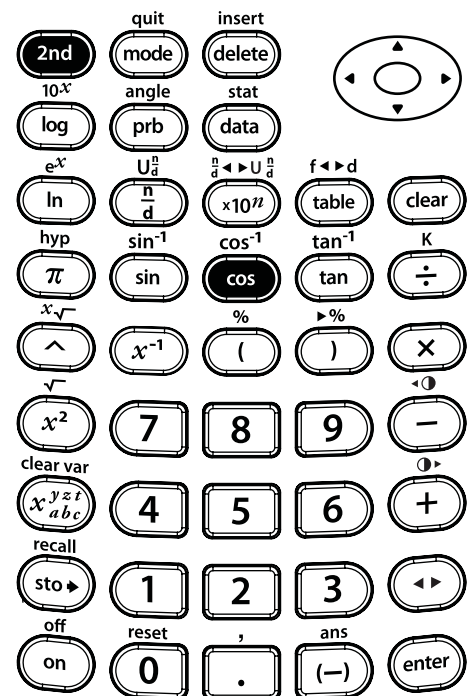

Sine

Use this formula to find the length of the ramp, D. Round your answer to the nearest whole number, and then return to floating decimal mode.

$$D = \frac{1.5}{\sin(12^\circ)} \text{ meters}$$

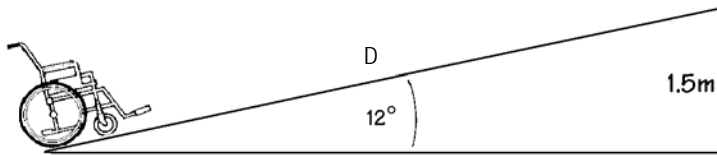

Press

Display

1 \cdot 5 $\frac{n}{d}$ \sin
12 $)$ **enter**

```

          1.5
        ----
sin(12)
        7.214601517
    
```

mode \downarrow \downarrow
enter

```

          FIX          DEG
MODE RAD GRAD
MODE SCI ENG
FLOAT 0 1 2 3 4 5 6 7 8 9
CLASSIC WAVE
    
```

clear **enter**

```

          FIX          DEG
sin(12)
          7.214601517
          -----
          1.5
sin(12)
          7
    
```

mode \downarrow \downarrow
enter **clear** **enter**

```

          DEG
sin(12)
          1.5
          -----
sin(12)
          7.214601517
    
```

The length of the ramp is $D = 7$ m rounded to the nearest whole number.

sin

```

          FIX          DEG
MODE RAD GRAD
MODE SCI ENG
FLOAT 0 1 2 3 4 5 6 7 8 9
CLASSIC WAVE
    
```

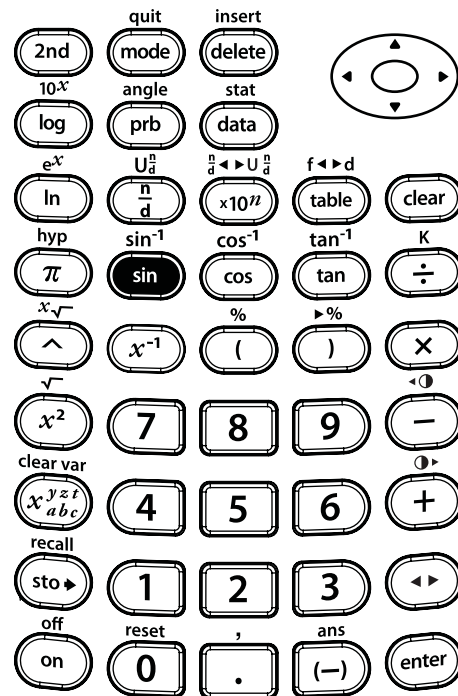

Inverse sine

Use this formula to find the angle of the conveyor belt, x . Round your answer to the nearest tenth, and then return to floating decimal mode.

$$x = \text{SIN}^{-1} \frac{13}{20} \text{ meters}$$

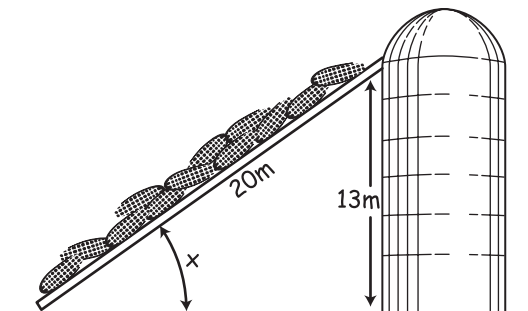

Press

Display

2nd **[sin⁻¹]** 13 **[n/d]**
20 **)** **enter**

```

DEG  +←→
sin-1(13/20)
40.54160187
    
```

mode **↓** **↓** **↓**
enter

```

FIX  DEG  +←→
DEG RAD GRAD
NORM SCI ENG
FLOAT 0 1 2 3 4 5 6 7 8 9
CLASSIC FRAC NUM
    
```

clear **enter**

```

FIX  DEG  +←→
>111 '(20)
40.54160187
sin-1(13/20) 40.5
    
```

mode **↓** **↓**
enter **clear** **enter**

```

DEG  +←→  ----
>111 '(20)
sin-1(13/20)
40.54160187
    
```

The angle of the conveyor belt is $x = 40.5^\circ$ rounded to the nearest tenth.

2nd **[sin⁻¹]**

```

FIX  DEG
DEG RAD GRAD
NORM SCI ENG
FLOAT 0 1 2 3 4 5 6 7 8 9
CLASSIC FRAC NUM
    
```

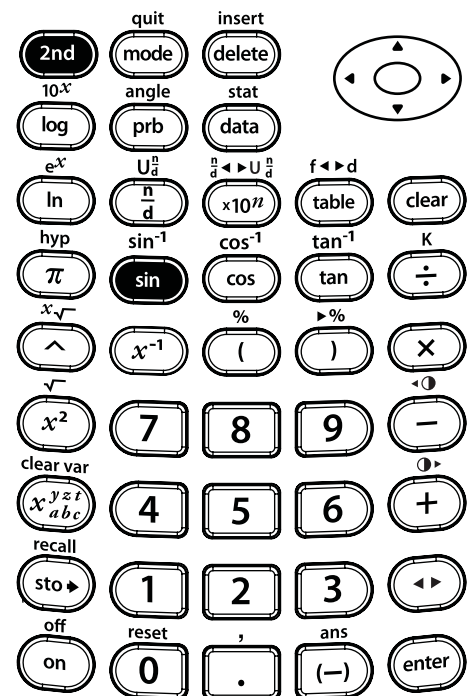

Keys

1. **2nd** [**hyp**] accesses the hyperbolic function (**sinh**, **cosh**, **tanh**; and **sinh⁻¹**, **cosh⁻¹**, **tanh⁻¹**) of the next trig key that you press.

Notes

- The example on the transparency masters assumes all default settings.
- Hyperbolic calculations are not affected by the angle mode setting—whether or not the calculator is in **RAD** (radian), **GRAD** (gradian), or **DEG** (degree) modes.

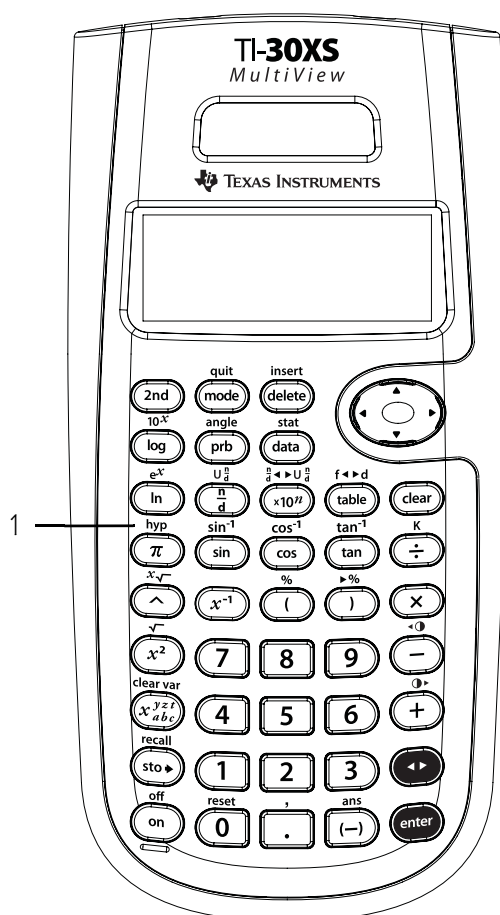

Sinh, cosh, and tanh

Find the $\sinh(2)$ and the $\sinh^{-1}(2)$. Repeat for \cosh and \tanh . What do you notice?

Press

Display

2nd **[hyp]** **sin** 2

) **enter**

DEG $\uparrow\downarrow$
sinh(2)
3.626860408

2nd **[hyp]** **2nd**

[sin⁻¹] **2nd** **[ans]**

) **enter**

DEG $\uparrow\downarrow$
sinh(2)
3.626860408
sinh⁻¹(Ans) 2

2nd **[hyp]** **cos** 2

) **enter**

DEG $\uparrow\downarrow$
cosh(2)
3.762195691

2nd **[hyp]** **2nd**

[cos⁻¹] **2nd** **[ans]**

) **enter**

DEG $\uparrow\downarrow$
cosh(2)
3.762195691
cosh⁻¹(Ans) 2

2nd **[hyp]** **tan** 2

) **enter**

DEG $\uparrow\downarrow$
tanh(2)
0.96402758

2nd **[hyp]** **2nd**

[tan⁻¹] **2nd** **[ans]**

) **enter**

DEG $\uparrow\downarrow$
tanh(2)
0.96402758
tanh⁻¹(Ans) 2

2nd **[hyp]**

DEG
DEG RAD GRAD
NORM SCI ENG
FLOA 0 123456789
CLASSIC MATHMATH

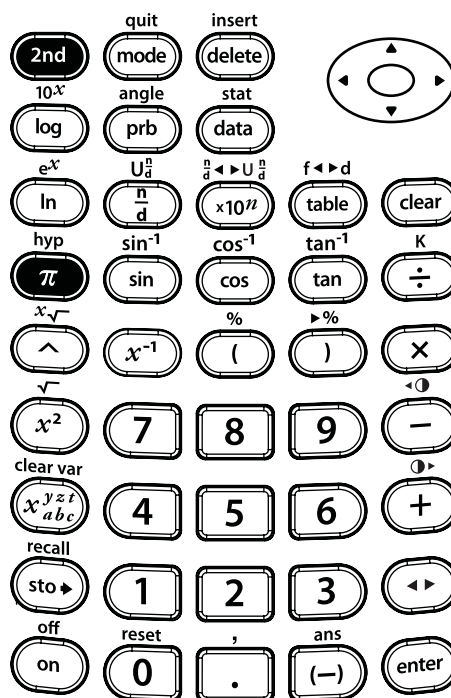

Quick reference to keys

A

KEY	FUNCTION
\leftarrow \rightarrow	\leftarrow \rightarrow move the cursor left and right so you can scroll an entry on the Home screen.
\leftarrow \rightarrow	Press 2nd \leftarrow or 2nd \rightarrow to scroll to the beginning or end of a current entry.
\uparrow \downarrow	\uparrow \downarrow move the cursor up and down to navigate menu items, view entries in the data editor and function table, and view previous entries on the Home screen.
2nd \uparrow	2nd \uparrow moves the cursor to the oldest entry on the Home screen, and to the top entry of the active column in Data editor.
2nd \downarrow	2nd \downarrow moves the cursor below the last entry on the Home screen, and to the bottom entry of the active column in Data editor.
+ - x ÷	Adds, subtracts, multiplies, and divides.
0 - 9	Enters the digits 0 through 9.
(Opens a parenthetical expression.
)	Closes a parenthetical expression.
x⁻¹	Calculates the reciprocal.
x²	Squares the value.
π	Enters the value of pi rounded to 10 digits (3.141592654).
.	Enters a decimal point.
(-)	Indicates the value is negative.
^	Raises a value to a specified power.
2nd	Turns on the 2nd indicator and accesses the function shown above the next key that you press.

A Quick reference to keys (Continued)

KEY	FUNCTION														
2nd [angle]	<p>Displays the following menus.</p> <p>DMS lets you specify the unit of an angle.</p> <p>R \leftrightarrow P lets you convert rectangular coordinates to polar coordinates, or vice versa.</p> <table style="width: 100%; border: none;"> <tr> <td style="text-align: center;"><u>DMS</u></td> <td style="text-align: center;"><u>R \leftrightarrow P</u></td> </tr> <tr> <td>1: °</td> <td>1: R \rightarrow Pr(</td> </tr> <tr> <td>2: ’</td> <td>2: R \rightarrow Pθ(</td> </tr> <tr> <td>3: ”</td> <td>3: P \rightarrow Rx(</td> </tr> <tr> <td>4: r</td> <td>4: P \rightarrow Ry(</td> </tr> <tr> <td>5: g</td> <td></td> </tr> <tr> <td>6: \rightarrow DMS</td> <td></td> </tr> </table>	<u>DMS</u>	<u>R \leftrightarrow P</u>	1: °	1: R \rightarrow Pr(2: ’	2: R \rightarrow Pθ(3: ”	3: P \rightarrow Rx(4: r	4: P \rightarrow Ry(5: g		6: \rightarrow DMS	
<u>DMS</u>	<u>R \leftrightarrow P</u>														
1: °	1: R \rightarrow Pr(
2: ’	2: R \rightarrow Pθ(
3: ”	3: P \rightarrow Rx(
4: r	4: P \rightarrow Ry(
5: g															
6: \rightarrow DMS															
x10ⁿ	x10ⁿ is a shortcut key to enter a number in scientific notation format.														
2nd [$\sqrt{\quad}$]	Calculates the square root.														
2nd [%]	Appends the % sign to a number. Results display according to the decimal notation mode setting.														
2nd [,]	Enters a comma.														
2nd [\sqrt{x}]	Calculates the specified root (x) of the value.														
2nd [$\text{U}\frac{n}{d}$]	Lets you enter mixed numbers and fractions. Press 2nd [$\text{U}\frac{n}{d}$] between the entry of the unit, and the numerator.														
$\frac{n}{d}$	Lets you enter a simple fraction. In MathPrint™ mode, press \odot between the entry of the numerator and the denominator. In Classic mode, press $\frac{n}{d}$ between the entry of the numerator and the denominator.														
2nd [$\text{a}\frac{n}{d}\rightarrow\text{U}\frac{n}{d}$]	Converts a simple fraction to a mixed number or a mixed number to a simple fraction.														
2nd [ans]	Recalls the most recently calculated result, displaying it as Ans .														
clear	Clears characters and error messages on the entry line.														
2nd [clear var]	Clears all memory variables.														
sin	Calculates the sine of an angle.														
2nd [\sin^{-1}]	Calculates the inverse sine.														
cos	Calculates the cosine of an angle.														

Quick reference to keys (Continued)

A

KEY	FUNCTION
2nd [\cos^{-1}]	Calculates the inverse cosine.
tan	Calculates the tangent of an angle.
2nd [\tan^{-1}]	Calculates the inverse tangent.
data	Lets you enter the statistical data points for 1-Var stats and 2-Var stats.
data data	Press data once to display the data editor screen. Press again to display the Clear and Formula menus. Lets you access list names when in the Formula menu.
delete	Deletes the character at the cursor.
2nd [e^x]	Calculates the natural antilogarithm (e raised to the power of the value).
2nd [$f \leftrightarrow d$]	Converts a fraction to its decimal equivalent or converts a decimal to its fractional equivalent, if possible.
2nd [hyp]	Accesses the hyperbolic function (sinh , cosh , tanh ; and sinh⁻¹ , cosh⁻¹ , tanh⁻¹) of the next trig key that you press.
2nd [insert]	Lets you insert a character at the cursor.
2nd [K]	Turns on the constant mode and lets you define a constant.
ln	Calculates the natural logarithm (base e , where $e \approx 2.718281828459$).
log	Calculates the common logarithm (base 10).
x^{yzt} <small>abc</small>	Accesses variables. Press this key multiple times to choose x , y , z , t , a , b , or c . You can also use x^{yzt} <small>abc</small> to recall the stored values for these variables.
2nd [off]	Turns off the calculator and clears the display.
on	Turns on the calculator.
prb	Displays the following menu of functions. nPr Calculates the number of possible permutations. nCr Calculates the number of possible combinations. ! Calculates the factorial. rand Generates a random number between 0 and 1. randint(Generates a random integer between 2 integers, A and B , where $A \leq \text{Randint} \leq B$.
2nd [recall]	Recalls the stored values to the display.

A

Quick reference to keys *(Continued)*





KEY	FUNCTION
2nd [stat]	<p>Displays the following menu from which you can select 1-Var, 2-Var, or StatVars.</p> <p>1-Var Analyzes data from 1 set of data with 1 measured variable—x.</p> <p>2-Var Analyzes paired data from 2 sets of data with 2 measured variables—x, the independent variable, and y, the dependent variable.</p> <p>StatVars After choosing 1-var or 2-var stats, displays data values.</p> <p>StatVars displays the following menu of stat variables with their current values.</p> <p>n Number of x (or x,y) data points.</p> <p>\bar{x} or \bar{y} Mean of all x or y values.</p> <p>Sx or Sy Sample standard deviation of x or y.</p> <p>σ_x or σ_y Population standard deviation of x or y.</p> <p>Σx or Σy Sum of all x values or y values.</p> <p>Σx^2 or Σy^2 Sum of all x^2 values or y^2 values.</p> <p>Σxy Sum of the product of x and y for all xy pairs in 2 lists.</p> <p>a Linear regression slope.</p> <p>b Linear regression y-intercept.</p> <p>r Correlation coefficient.</p> <p>x' (2-Var) Uses a and b to calculate predicted x value when you input a y value.</p> <p>y' (2-Var) Uses a and b to calculate predicted y value when you input an x value.</p> <p>minX Minimum of x values.</p> <p>Q1 (1-Var) Median of the elements between minX and Med (1st quartile).</p> <p>Med Median of all data points.</p> <p>Q3 (1-Var) Median of the elements between Med and maxX (3rd quartile).</p> <p>maxX Maximum of x values.</p>

Quick reference to keys (Continued)

KEY	FUNCTION
$\boxed{2nd}$ \boxed{reset}	<p>Displays the RESET menu.</p> <p>RESET</p> <p>1: No</p> <p>2: Yes</p> <p>Press 1 (No) to return to the previous screen without resetting the calculator.</p> <p>Press 2 (Yes) to reset the calculator. The message MEMORY CLEARED is displayed.</p> <p>You can press \boxed{on} and \boxed{clear} simultaneously to reset the calculator immediately. No menu or message is displayed.</p>
$\boxed{sto \blacktriangleright}$	<p>Lets you store values to variables. Press $\boxed{sto \blacktriangleright}$ to store a variable, and press $\boxed{x^{yzt}}$ to select the variable to store.</p> <p>$\boxed{x^{yzt}}$ displays the following menu of variables: x y z t a b c.</p> <p>Press \boxed{enter} to store the value in the selected variable. If this variable already has a value, that value is replaced by the new one.</p>
\boxed{enter}	<p>Completes the operation or executes the command.</p>

Display indicators

B

INDICATOR	MEANING
2nd	2nd function.
HYP	Hyperbolic function.
FIX	Fixed-decimal setting. (See the Mode section in Chapter 1, TI-30XS MultiView™ basic operations, and Chapter 7, Decimals and decimal places.)
SCI, ENG	Scientific or engineering notation. (See the Mode section in Chapter 1, TI-30XS MultiView basic operations.)
DEG, RAD, GRAD	Angle mode (degrees, radians, or gradians). (See the Mode section in Chapter 1, TI-30XS MultiView basic operations.)
K	Constant feature is on.
L1, L2, L3	Displays above the lists in data editor.
	The TI-30XS MultiView calculator is performing an operation.
↑↓	An entry is stored in memory before and/or after the active screen. Press  and  to scroll.
←→	An entry or menu displays beyond 16 digits. Press  or  to scroll.

Error messages

C

When the TI-30XS MultiView™ calculator detects an error, it returns an error message with the type of error.

To correct the error, note the error type and determine the cause of the error. If you cannot recognize the error, use the following list, which describes error messages in detail.

Press **clear** to clear the error message. The previous screen is displayed with the cursor at or near the error location. Correct the expression.

MESSAGE	MEANING
ARGUMENT	A function does not have the correct number of arguments.
DIVIDE BY 0	You attempted to divide by 0. In statistics, $n = 1$.
DOMAIN	You specified an argument to a function outside the valid range. For example: For $\sqrt[x]{y}$ — $x = 0$ or $y < 0$ and x is not an odd integer. For y^x — $y = 0$ and $x = 0$; $y < 0$ and x is not an integer. For \sqrt{x} — $x < 0$. For LOG or LN — $x \leq 0$. For TAN — $x = 90^\circ, -90^\circ, 270^\circ, -270^\circ, 450^\circ, \text{etc.}$ For SIN⁻¹ or COS⁻¹ — $ x > 1$. For nCr or nPr — n or r are not integers ≥ 0 . For $x!$ — x is not an integer between 0 and 69.
EQUATION LENGTH ERROR	An entry exceeds the available space (80 digits for statistics entries or 47 for constant entries); for example, combining an entry with a constant that exceeds the limit.
FRQ DOMAIN	FRQ value (in 1-variable statistics) < 0 or > 99 .
OVERFLOW	$ \theta \geq 1 \times 10^n$, where θ is an angle in a trig, hyperbolic, or RPr function.
STAT	Attempting to calculate 1-var or 2-var stats with no defined data points, or attempting to calculate 2-var stats when the data lists are not of equal length.
DIM MISMATCH	Attempting to create a formula when the lists are not of equal length.
FORMULA	The formula does not contain a list name (L1, L2, or L3), or the formula for a list contains its own name; for example, a formula for L1 contains L1.

Error messages (Continued)

MESSAGE	MEANING
SYNTAX	The command contains a syntax error—entering more than 23 pending operations, 8 pending values, or having misplaced functions, arguments, conversions, variables, parentheses, or commas. If using $\frac{\square}{\square}$, try using $\frac{\square}{\square}$.
INVALID FUNCTION	You entered an invalid function in the function table.
LOW BATTERY	Replace the battery. Note: This message displays briefly and then disappears. Pressing clear does not clear this message.

For general information

Home Page:	<i>education.ti.com</i>
KnowledgeBase and e-mail inquiries:	<i>education.ti.com/support</i>
Phone:	<i>(800) TI-CARES / (800) 842-2737 For U.S., Canada, Mexico, Puerto Rico, and Virgin Islands only</i>
International Information:	<i>education.ti.com/international</i>

For technical support

KnowledgeBase and e-mail inquiries:	<i>education.ti.com/support</i>
Phone (not toll-free):	<i>(972) 917-8324</i>

For product (hardware) service

Customers in the U.S., Canada, Mexico, Puerto Rico and Virgin Islands:	<i>Always contact Texas Instruments Customer Support before returning a product for service.</i>
All other customers:	<i>Refer to the leaflet enclosed with this product (hardware) or contact your local Texas Instruments retailer/distributor.</i>

Battery precautions

- Do not leave batteries within the reach of children.
- Do not mix new and used batteries. Do not mix brands (or types within brands) of batteries.
- Do not mix rechargeable and non-rechargeable batteries.
- Install batteries according to polarity (+ and -) diagrams.
- Do not place non-rechargeable batteries in a battery recharger.
- Properly dispose of used batteries immediately.
- Do not incinerate or dismantle batteries.
- Seek Medical Advice immediately if a cell or battery has been swallowed. (In the USA, contact the National Capital Poison Center at 1-800-222-1222.)

Battery disposal

Do not mutilate, puncture, or dispose of batteries in fire. The batteries can burst or explode, releasing hazardous chemicals. Discard used batteries according to local regulations.

Remove or replace the battery

Remove the protective cover and turn the TI-30XS MultiView™ face downwards.

- With a small screwdriver, remove the screws from the back of the case.
- From the bottom, carefully separate the front from the back. **BE CAREFUL** not to damage any of the internal parts.
- With a small screwdriver (if required), remove the battery.
- To replace the battery, check the polarity (+ and -) and slide in a new battery. Press firmly to snap the new battery into place. **Important:** When replacing the battery, avoid any contact with the other components of the TI-30XS MultiView calculator.
- If necessary, press **on** and **clear** simultaneously to reinitialize the calculator (erases the memory and all the settings and displays a MEM DELETED message).
- Dispose of the dead batteries immediately and in accordance with local regulations.

Type of battery

The TI-30XS MultiView calculator uses one 3 volt CR2032 lithium battery.

Per CA Regulation 22 CCR 67384.4, the following applies to the button cell battery in this unit:

Perchlorate Material - Special handling may apply.

See www.dtsc.ca.gov/hazardouswaste/perchlorate

